

User Guide

www.tendacn.com



Wireless N300 Powerline AP

Copyright Statement

Tenda is the registered trademark of Shenzhen Tenda Technology Co., Ltd. All the products and product names mentioned herein are the trademarks or registered trademarks of their respective holders. Copyright of the whole product as integration, including its accessories and software, belongs to Shenzhen Tenda Technology Co., Ltd. Without prior expressed written permission from Shenzhen Tenda Technology Co., Ltd, any individual or party is not allowed to copy, plagiarize, reproduce, or translate it into other languages.

All photos and product specifications mentioned in this manual are for references only. Upgrades of software and hardware may occur; Tenda reserves the right to revise this publication and to make changes in the content hereof without obligation to notify any person or organization of such revisions or changes. If you would like to know more about our product information, please visit our website at <http://www.tendacn.com>.

Table of Contents

COPYRIGHT STATEMENT	2
TABLE OF CONTENTS.....	3
CHAPTER 1 PRODUCT OVERVIEW	6
1.1 PACKAGE CONTENTS (FOR REFERENCES ONLY)	6
1.2 LED OVERVIEW.....	7
1.3 INTERFACE/BUTTON OVERVIEW.....	9
1.4 FEATURES.....	10
1.5 SAFETY CONSIDERATIONS	11
CHAPTER 2 HARDWARE INSTALLATION	13
2.1 INSTALLATION METHOD.....	13
2.2. INSTALLATION INSTRUCTIONS	14
2.3 VERIFY PHYSICAL CONNECTION	16
CHAPTER 3 INTERNET CONNECTION SETUP.....	17
3.1 CONFIG TCP/IP SETTINGS ON YOUR PC	17
3.2. LOGIN TO WEB UTILITY	25
3.3 QUICK ENCRYPTION	26

CHAPTER 4 STATUS	29
4.1 LAN STATUS.....	29
4.2 PLC STATUS.....	29
4.3 WIRELESS STATUS.....	30
4.4 GENERAL INFO	31
CHAPTER 5 LAN SETTINGS.....	32
CHAPTER 6 WIRELESS SETTINGS.....	34
6.1 WIRELESS BASIC SETTINGS	34
6.2 WIRELESS SECURITY.....	36
6.2.1 WEP	37
6.2.2 WPA-PSK	38
6.2.3 WPA2-PSK	39
6.3 WIRELESS ACCESS CONTROL	39
6.4 WPS SETTINGS.....	42
6.5 CONNECTION STATUS	44
CHAPTER 7 PLC SETTINGS.....	45
7.1 PLC NETWORK SETTINGS	46
7.2 PLC MEMBER SETTINGS	48

7.2.1 PLC Device List	49
7.2.2 Add PLC Device	50
7.2.3 PLC Authentication List	50
7.3 PLC QoS SETTINGS.....	52
7.3.1 Simple Priority Mapping	53
7.3.2 Advanced Priority Mapping	54
CHAPTER 8 TOOLS	58
8.1 FIRMWARE UPDATE.....	58
8.2 BACKUP & RESTORE SETTINGS	59
8.3. RESTORE TO FACTORY DEFAULT SETTINGS.....	63
8.4 CHANGE PASSWORD	64
8.5 SYSLOG	65
8.6 REBOOT.....	66
CHAPTER 9 PAIR BUTTON.....	67
APPENDIX 1 FAQS.....	70
APPENDIX 2 TECHNICAL SPECIFICATION.....	74
APPENDIX 3 SAFETY AND EMISSION STATEMENT	76

Chapter 1 Product Overview

The PW201A Wireless N Powerline AP uses your home's existing electrical wiring to connect everything together. It provides the freedom and flexibility of a Wi-Fi network and fast wired connection. Getting set up is simple. All you need is two Tenda Powerline devices or more. With Powerline speed of up to 200 Mbps, coupled with Wireless N speed of up to 300Mbps, it expands your Powerline network to the far corners of your home to eliminate dead spots and deliver whole home coverage.

QoS support prioritizes delay-sensitive applications such as Web Surfing, IPTV, Video/Audio, VoIP and Gaming and specified traffic such as data assigned with IP/MAC based priority.

Plus, it provides a set of security features such as 128-bit AES encryption over Powerline network, WEP, WPA-PSK, WPA2-PSK, Mixed WPA/WPA2-PSK, WPS over wireless network and a Pair button to quickly establish a secure Powerline connection.

Combining the feature of wired, wireless and Powerline communication, the PW201A delivers an incredibly reliable and cost effective solution to a variety of home networking needs as well as to expand a small-sized network.

1.1 Package Contents (For references only)





- PW201A Powerline Wireless AP

- Quick Install Guide
- Ethernet Cable
- CD-ROM

1.2 LED Overview



Figure 1-1 Front Panel

LED	Color	Status	Description
 Power	Green	Off	Device is NOT receiving electrical power.
		Solid	Device is receiving electrical power.
 PLC	Green	Off	Powerline connection is NOT established.
		Solid	Powerline connection is established with no data transmission.
		Fast Blink	2-3 blinks per second during data transmission
		Slow Blink	Blinks slowly while pairing with other PLC devices.
 LAN	Green	Off	Cable NOT connected
		Solid	Cable connected
		Blinking	Data being transmitted
 Wireless	Green	Off	Wireless disabled
		Solid	Wireless enabled
		Blinking	Data being transmitted
 WPS	Green	Off	WPS disabled
		Solid	WPS enabled
		Blinking	Performing WPS authentication

1.3 Interface/Button Overview

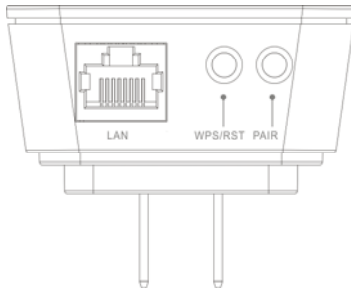

Figure 2-2 Interface/Button

Interface /Button	Description
LAN	RJ45 port: Connect it to a PC or other network devices using an Ethernet cable.
WPS/RST	One-touch Encryption/Reset Button: Press for 1-3 seconds to perform WPS authentication; press for 6-10 seconds to reset the Device.
PAIR	Pair Button: Press for 1-3 seconds to pair with other PLC devices; press for 9-10 seconds to disconnect from the existing network;

1.4 Features

- Compliant with HomePlugAV, IEEE 802.3, IEEE 802.3u, IEEE 802.11b, IEEE 802.11g, IEEE 802.11n;
- Plug and Play; delivers data and power through existing electric wires;
- Up to 200Mbps Powerline transmission rate;
- Powerline transmission distance of up to 300 meters;
- Up to 300Mbps wireless transmission rate;
- Web based management UI to manage both wireless and PLC features concurrently;
- QoS prioritizes specified services or applications;
- Default network name: HomePlugAV
- Compatible with all other manufacturers' HomePlugAV-compliant devices;
- Advanced 128-bit AES encryption to ensure data security on Powerline network;
- 1 x Pair button to quickly establish a secure and private Powerline network with other Powerline devices;
- Wireless security features of WEP, WPA-PSK, WPA2-PSK, Mixed WPA/WPA2-PSK, WPS and wireless access control, etc to secure your wireless network;

- 1 * WPS button to quickly establish a secure wireless connection.

1.5 Safety Considerations

Observe the following to avoid any potential harm caused from improper use.

- DO NOT expose the Device to flammable , conductive or humid objects;
- Make sure there is no worn-out electric wire and other appliances are stably placed.
- Operate it in a well-ventilated environment.
- DO NOT expose the Device to sun shine or other heat sources;
- DO NOT expose the Device to corrosive substances (such as acid and alkali, etc)
- Connect the Device to a wall outlet that matches rated power requirements.
- Input voltage fluctuation should be less than 10%.
- For optimal result, connect the Device to a regular wall outlet without any other devices like hair drier, electric iron, fridge or charger connected to the same outlet.
- Read the Quick Installation Guide before using the Device.

- Note all safety instructions stated in both user guide and quick installation guide.
- Use of accessories that are not included with this product may cause fire or damage.
- DO NOT place any objects on the Device.
- DO NOT expose the Device to water. Keep it clean.
- It is advisable to disconnect the Device from power outlet and any other connections in lightning and storm weather though it is lightning-proof;
- Clean the Device with a piece of soft and dry cloth.
- Do NOT use liquid or aerosol cleaner.
- Do unplug it from wall outlet before cleaning.
- DO disconnect the Device from power supply when not in use.
- Keep ventilator clean and unblocked. Substances or objects that fall into it may cause short circuit, worse even, cause fire or damage the Device.
- DO NOT spray any liquid onto the Device surface.
- DO NOT open the Device's shell/outer case whether working or not.
- Be careful when unplugging the Device from wall outlet. It may be hot.
- Contact Tenda technical staff if you are running into problems that you are not able to solve.

Chapter 2 Hardware Installation

2.1 Installation Method

Method 1

Establish a Powerline network for LAN communication. Simply plug the Tenda PW201A and Tenda P200 (Powerline adapter) into different wall outlets within the same power circuitry and set IP addresses of PCs on LAN to the same net segment as the Powerline devices. And the PCs will be able to intercommunicate.

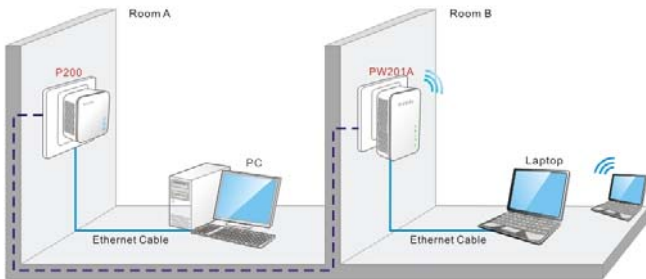

Figure 1-3 Establish a Powerline Network

Method 2

Connect Powerline Network to Internet. Connect a Powerline adapter, say, Tenda P200, to an Internet-enabled ADSL Modem Router using an Ethernet cable; plug the PW201A into another wall outlet within the same

power circuitry as the Tenda P200. And PCs connected to the PW201A wirelessly or using an Ethernet cable will be able to access Internet then.

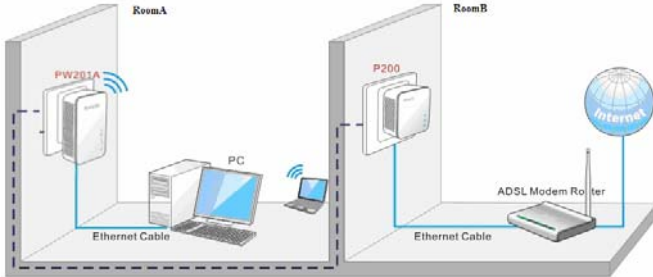

Figure 1-4 Connect Powerline Network to Internet

2.2. Installation Instructions

1. Connect a Powerline adapter, say, Tenda P200, to an Internet-enabled Router and then plug it into a wall outlet as seen in figure 1-5:

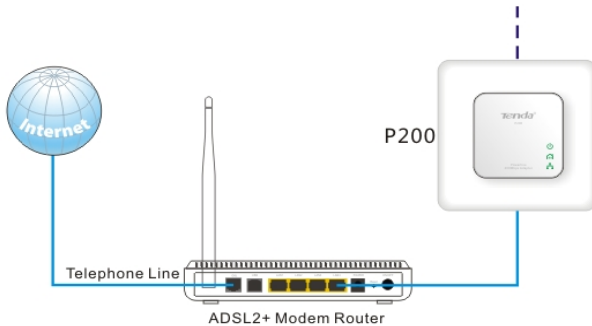

Figure 1-5 Network Connection

2. Plug the PW201A to a wall outlet within the same power circuitry as the Tenda P200 and connect your PC to it via a wireless or wired connection (The latter requires an Ethernet cable) as seen in figure 1-6:

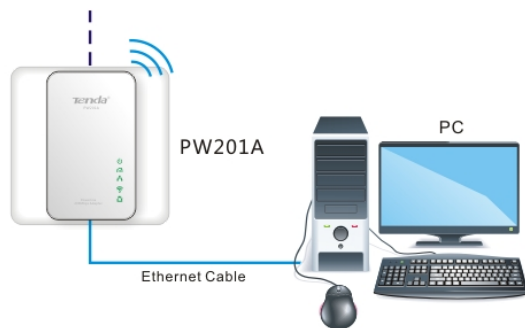

Figure 1-6 Terminal Connection

3. Then the PW201A pairs automatically with P200 to establish a Powerline network. A successful connection may be established. If relevant LEDs do not display lights the way they should be, double check the connection. Figure 1-7 presents a whole diagram of installation completed.

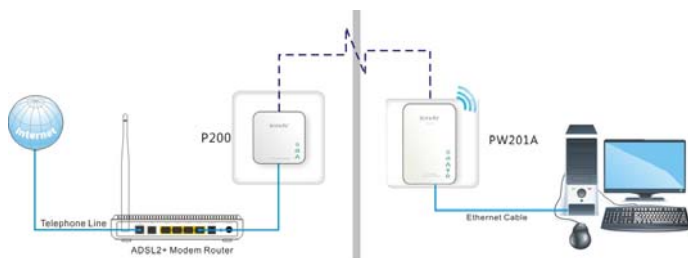

Figure 1-7 Installation Completed

4. Simply set all PCs connected to the PW201A to "Obtain an IP address automatically", and they may be able to access Internet then.

2.3 Verify Physical Connection

Below connections must be verified before moving ahead.

1. Verify Power connection

Power connectivity is confirmed when the Power LED on the Device is illuminated.

2. Verify Ethernet connection

Ethernet connectivity is confirmed when the LAN LED on the Device is illuminated. Namely, other network devices (such PC, ADSL Modem or Router, etc) are connected to the Device.

3. Verify Powerline connection

Powerline connectivity is confirmed when the PLC LED on the Device is illuminated. Namely, the Device has been successfully connected to another Powerline device.

Chapter 3 Internet Connection Setup

3.1 Config TCP/IP settings on your PC

If you are using Windows XP, do as follows:

1. Click Start-> Control Panel-> Network and Internet Connections-> Network Connections

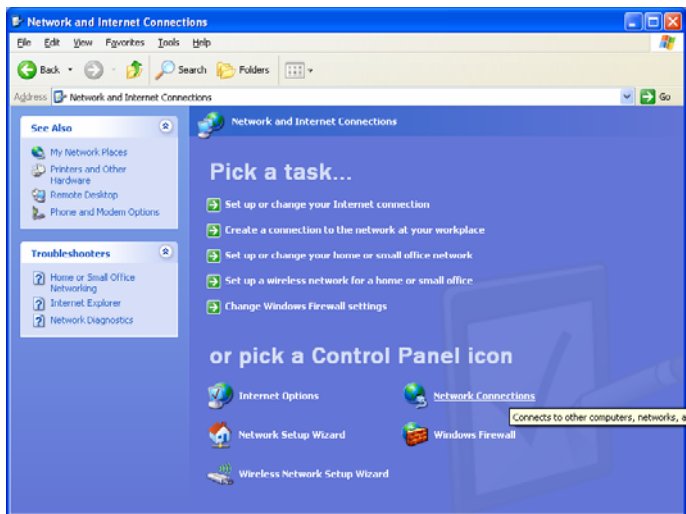

2. Right-click on the Local Area Connection and select Properties.

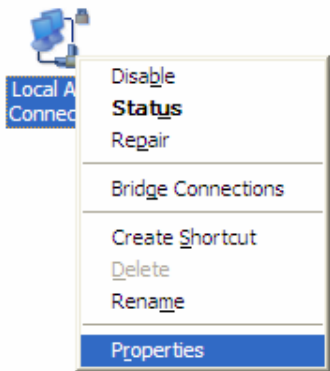

3. Select Internet Protocol (TCP/IP) and click Properties.

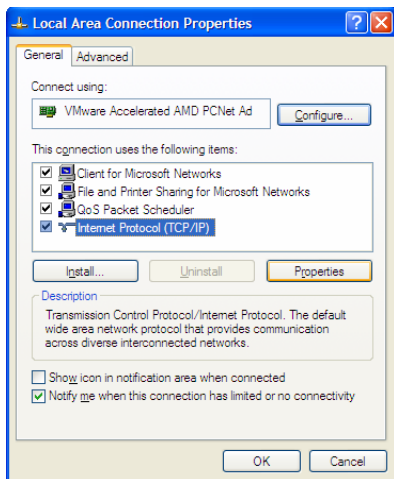

4. Select "Use the following IP address".

IP address: Enter 192.168.0.xxx where xxx can be any number between 2 and 253).

Subnet mask: Enter 255.255.255.0.

Default gateway: Enter 192.168.0.1.

Preferred DNS server: Set Preferred (Primary) DNS the same as the LAN IP address of your Device (192.168.0.254) if you don't know your local DNS server's address (Or consult your ISP). The Alternate (Secondary) DNS is not needed or you may enter one from your ISP.

Click OK twice to save your settings.

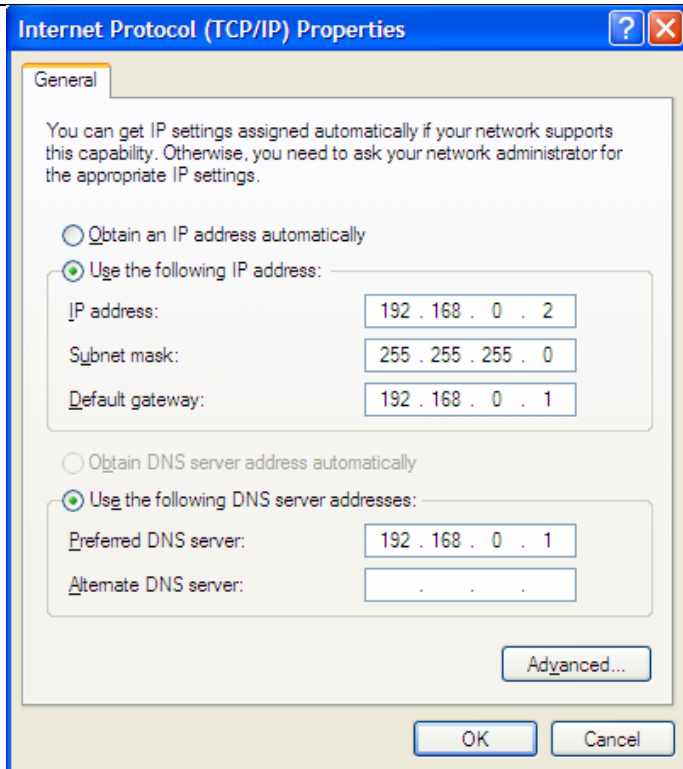

If you are using Windows 7, do as follows:

1. Click on Start > Control Panel > Network and Internet > Network and Sharing Center.

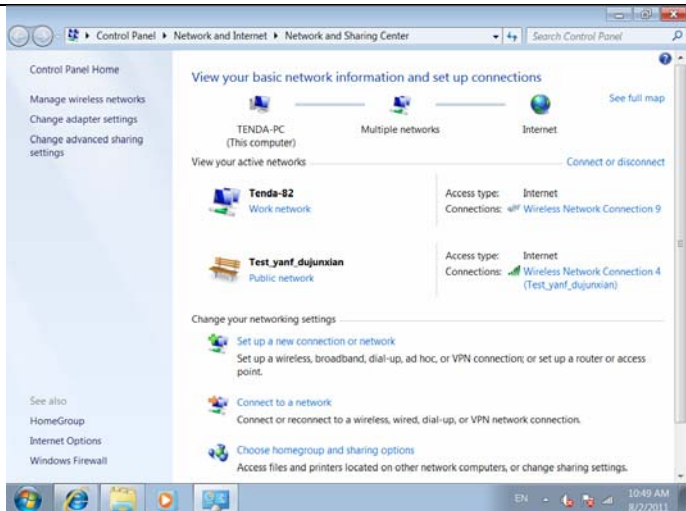

2. Click "Change adapter settings".

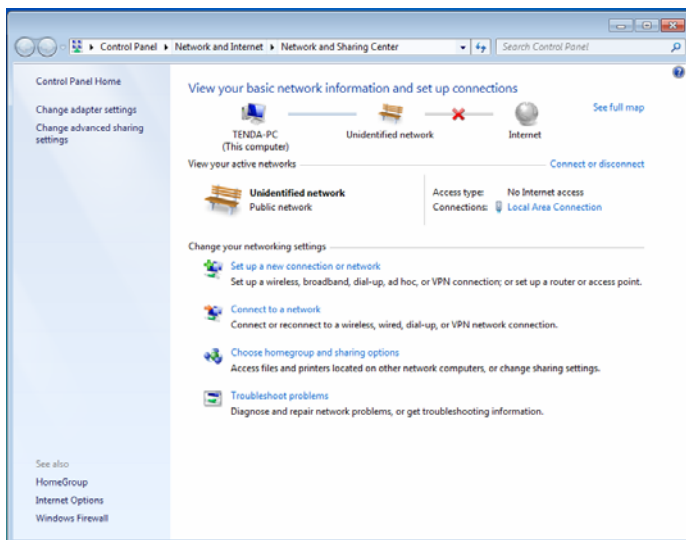

3. Right-click on the Local Area Connection and select Properties.

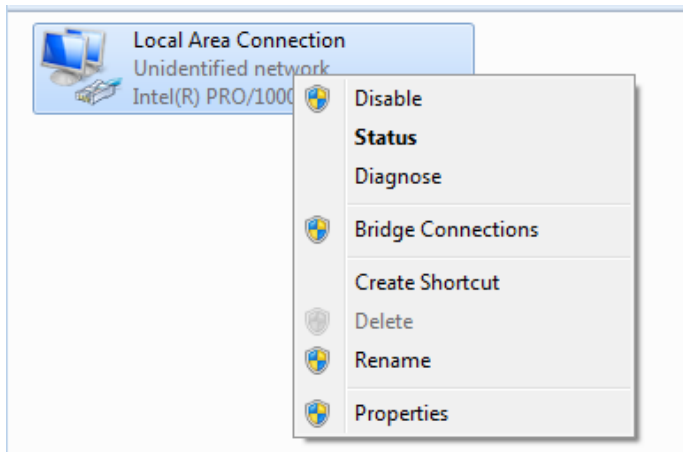

4. Select Internet Protocol Version 4 (TCP/IPv4) and click Properties or directly double-click on Internet Protocol Version 4 (TCP/IPv4).

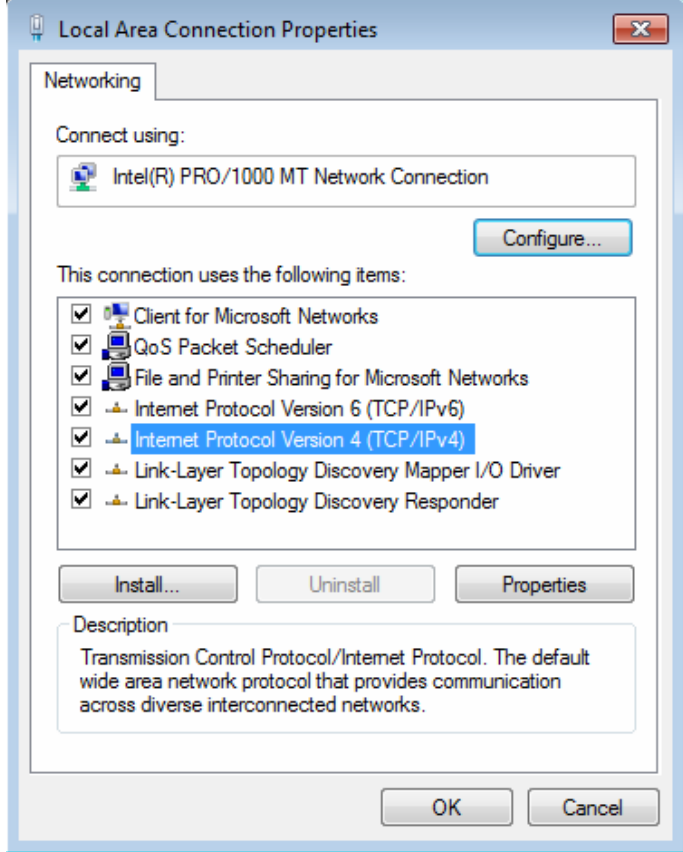

5. Select "Use the following IP address".

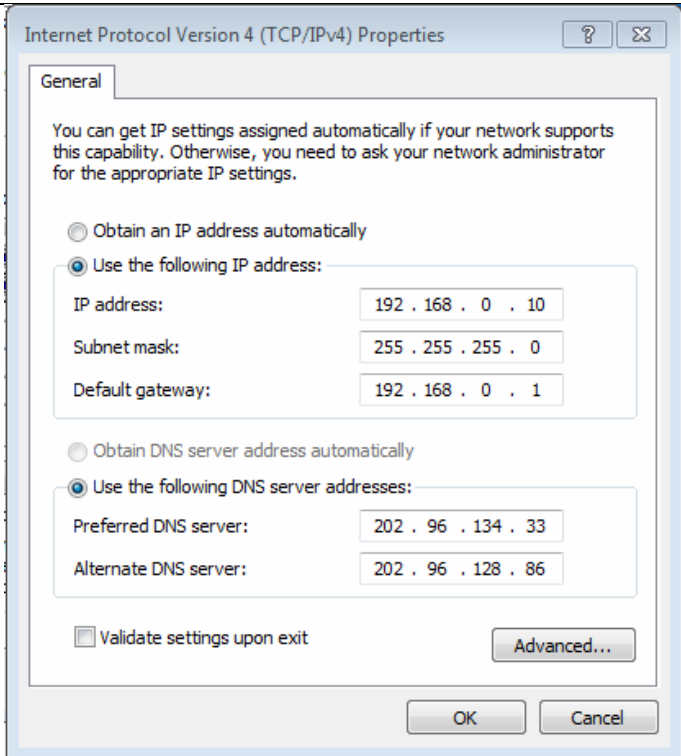

IP address: Enter 192.168.0.xxx where xxx can be any number between 2 and 253).

Subnet mask: Enter 255.255.255.0.

Default gateway: Enter 192.168.0.1.

Preferred DNS server: Set Preferred (Primary) DNS the same as the LAN IP address of your Device (192.168.0.254) if you don't know your local

DNS server's address (Or consult your ISP). The Alternate (Secondary) DNS is not needed or you may enter one from your ISP.

Click OK twice to save your settings.

3.2. Login to Web Utility

1. Launch a web browser, in the address bar, input 192.168.0.254 and press "Enter".



2. Enter "admin" in both User Name and Password fields and then click Login

A screenshot of the Tenda Powerline AP login page. The page has a yellow header with the text "Tenda Powerline AP". Below the header, there are two input fields. The first is labeled "User Name:" and contains the text "admin". To its right is the text "(Default User Name: admin)". The second is labeled "Password:" and contains five black dots. To its right is the text "(Default Password: admin)". Below the input fields are two buttons: "Login" and "Cancel".

3. If you entered a correct user name and a correct password, you will see the home page of the Device's web utility.



3.3 Quick Encryption

On the home page, you can quickly encrypt your wireless network. The default security settings preset on this page are as follows:

Security Mode: WPA2-PSK

Cipher Type: AES

Security Key: 12345678

The security key is configurable. You can change it to something catchy or meaningful.



- **SSID:** Displays Device's current wireless network name.
- **Security Key:** Specify a security key of 8-63 ASCII or 64 Hex characters and enable WPA2-PSK/AES to encrypt your wireless network. The security key is configurable. You can change it to something catchy or meaningful to yourself.
- **Advanced:** Click the "Advanced" button to enter Device's main Interface as seen below.

The screenshot displays the Tenda PW201A web interface. At the top, there is a yellow navigation bar with the Tenda logo on the left and the text "Firmware Version: V1.0.5_m" and "Product Name: Powerline AP Model: PW201A" on the right. Below the navigation bar are tabs for "Status", "Network", "Wireless", "PLC", and "Tools". The "Status" tab is selected, and the page content is organized into several sections:

- LAN Status:** Displays IP Address (192.168.0.254), Subnet Mask (255.255.255.0), and LAN MAC Address (00:90:4C:88:88:88).
- PLC Status:** Displays Network Name (HomePlugAV1), Device Password (AAAA-BBBB-CCCC-DDDD), and PLC MAC Address (C8:3A:35:22:22:23).
- Wireless Status:** Displays Wireless Status (Enable), BSSID (B2:13:96:8080), SSID (Tenda_F208C0), Current Channel (1 Channel), and Security Mode (None).
- General Info:** Displays Up Time (0 day 00:04:31), Client Count (1), Firmware Version (V1.0.5_m), and Hardware Version (V1.0).

On the right side, there is a "Helpful Hints" section with a "Status" heading. It contains three paragraphs: "PLC Status: Displays the PLC device info.", "This section mainly displays LAN, PLC, wireless status and info.", and "Firmware Version: Displays firmware version."

Chapter 4 Status

This section allows you to view Device's LAN/PLC/wireless/system status.

4.1 LAN Status

LAN Status	
IP Address	192.168.0.254
Subnet Mask	255.255.255.0
LAN MAC Address	00:90:4C:88:88:88

- **IP Address:** Displays Device's LAN IP, namely the management IP.
- **Subnet Mask:** Displays Device's LAN subnet mask.
- **LAN MAC Address:** Displays Device's LAN MAC address.

4.2 PLC Status

PLC Status	
Network Name	HomePlugAV1
Device Password	AAAA-BBBB-CCCC-DDDD
PLC MAC Address	C8:3A:35:22:22:23

- Network Name: Displays Device's network name.
- Device Password: Displays Device's password.
- PLC MAC Address: Displays Device's PLC MAC address.

4.3 Wireless Status

Wireless Status	
Wireless Status	Enable
802.11Mode	802.11b/g/n mixed
SSID	Tenda_F20BC0
Current Channel	1 Channel
Security Mode	None

- Wireless Status: Displays whether wireless is enabled on the Device.
- **802.11 Mode:** Displays current network mode.
- **SSID:** Displays Device's wireless network name.
- Current Channel: Displays the channel on which Device is currently operating.
- Security Mode: Displays the security mode enabled on the Device.

4.4 General Info

General Info	
Up Time	0 day 00:04:31
Client Count	1
Firmware Version	V1.0.5_en
Hardware Version	V1.0

- Up Time: Displays uptime.
- Client Count: Displays the number of connected clients.
- Firmware Version: Displays Device's firmware version.
- Hardware Version: Displays Device's hardware version.

Chapter 5 LAN Settings

This section allows you to configure Device's LAN settings.

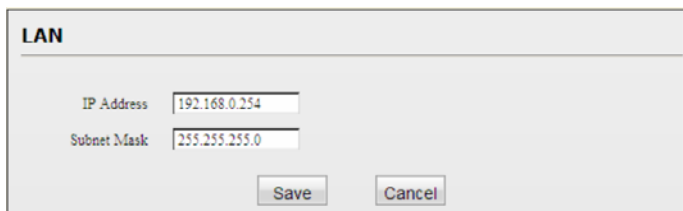

LAN

IP Address: 192.168.0.254

Subnet Mask: 255.255.255.0

Save Cancel

- **IP Address:** Device's LAN IP, namely the management IP. The default is 192.168.0.254. You can change it according to your need.
- **Subnet Mask:** Device's LAN subnet mask. The default is 255.255.255.0. You can change it according to your need.

Note:

1. If you change the Device's LAN IP address, you will need to set IP addresses of PCs on LAN to the same IP net segment as Device's new IP address and enter the new IP in your browser to get back to the web-based configuration utility. 2. If you want to manage the Device while accessing Internet in the meantime, you will need to set Device's LAN IP to the same IP net segment as the Internet-enabled router. For example, assuming the Internet-enabled router is at the IP address of 192.168.1.1, then, you may set Device's LAN IP address to "192.168.1.254" and set your PC to "Obtain

an IP address automatically". And now you will be able to manage the Device while surfing Internet.

Chapter 6 Wireless Settings

6.1 Wireless Basic Settings

Wireless - Basic

Enable Wireless

Region: Europe

802.11 Mode: 11b/g/n mixed

SSID: Tenda_F20BC0

Broadcast SSID: Enable Disable

Channel: Auto-Select

Channel Bandwidth: 20 20/40

Extension Channel: Auto-Select

WMM Capable: Enable Disable

APSD Capable: Enable Disable

Save Cancel

- **Wireless:** Check/uncheck to enable/disable the wireless feature. If disabled, all wireless-dependent features will be disabled accordingly.
- **Region:** Select your location (country or region).
- **802.11 Mode:** Select a right mode according to your wireless client. The default mode is 11b/g/n mixed.
- **11b mode :** Select it if you have only Wireless-B clients in your wireless network.

- 11g mode: Select it if you have only Wireless-G clients in your wireless network.
- 11b/g mixed mode: Select it if you have only Wireless-B and Wireless-G clients in your wireless network.
- 11b/g/n mixed mode: Select it if you have Wireless-B, Wireless-G and Wireless-N clients concurrently present in your wireless network.
- SSID: A SSID (Service Set Identifier) is the unique name of a wireless network. This field is configurable.
- SSID Broadcast: Select “Enable”/“Disable” to make your wireless network visible/ invisible to any wireless clients within coverage when they perform a scan to see what’s available. By default, it is enabled. When disabled, this SSID becomes invisible to any wireless clients within the coverage. Manually enter the SSID if you want to connect to it.
- Channel: For an optimal wireless performance, you may select the least interferential channel. It is advisable that you select an unused channel or “Auto” to let device detect and select the best possible channel for your wireless network to operate on from the drop-down list.
- Channel Bandwidth: Select a proper channel bandwidth to enhance wireless performance. When there are 11b/g and 11n wireless clients, please select the 802.11n mode of 20/40M, when there are only non-11n wireless clients, select 20M frequency band mode; when the wireless network mode is 11n mode, please select 20/40 frequency band to boost its throughput.

- Extension Channel : Available only in 11b/g/n mixed mode.
- WMM-Capable: WMM is QoS for your wireless network. Enabling this option may better stream wireless multimedia data (such as video or audio).
- ASPD Capable: Select to enable/disable the auto power saving mode on WMM. By default, this option is disabled.

6.2 Wireless Security

This section allows you to encrypt your wireless network to block unauthorized accesses and malicious packet sniffing.

The Device provides multiple security modes: WEP (Open and Shared), WPA-PSK, WPA2-PSK and Mixed WPA/WPA2-PSK.

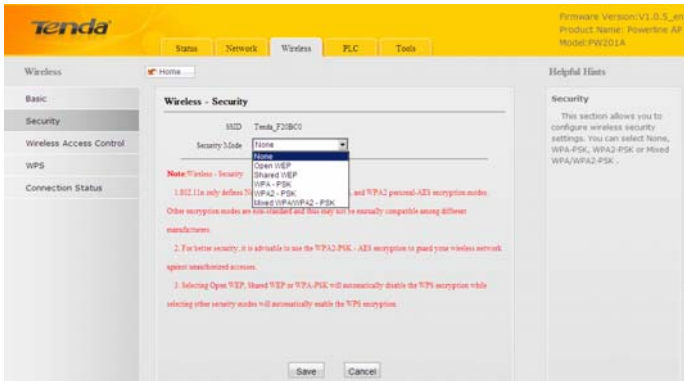

 **Note:**

Selecting Open WEP, Shared WEP or WPA-PSK will automatically disable the WPS encryption while selecting None, WPA2-PSK or Mixed WPA/WPA2-PSK will automatically enable the WPS encryption.

6.2.1 WEP

WEP is intended to provide data confidentiality comparable to that of a traditional wired network.

Two methods of authentication can be used with WEP: Open System authentication and Shared Key authentication.

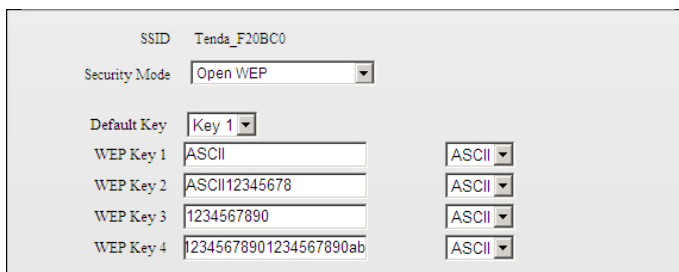

The screenshot shows a configuration window for WEP. At the top, the SSID is set to 'Tenda_F20BC0'. Below it, the Security Mode is set to 'Open WEP' in a dropdown menu. Underneath, the Default Key is set to 'Key 1' in a dropdown menu. There are four rows for WEP keys. Each row has a text input field for the key and a dropdown menu for the key type (ASCII or Hex). The first row is for WEP Key 1, with the key type set to ASCII. The second row is for WEP Key 2, with the key type set to ASCII and the key value '123456789'. The third row is for WEP Key 3, with the key type set to ASCII and the key value '1234567890'. The fourth row is for WEP Key 4, with the key type set to ASCII and the key value '12345678901234567890ab'.

- Security Mode: Select a proper security mode from the drop-down list.
- Default Key: Select a key from the preset keys 1-4 for current use.
- Default Key: Select a key from the preset keys 1-4 for current use.
- WEP Key: Select ASCII or Hex. ASCII: When selected, define a WEP key of 5 or 13 ASCII characters;
Hex: When selected, define a WEP key of 10 or 26 hex characters.

6.2.2 WPA-PSK

The WPA protocol implements the majority of the IEEE 802.11i standard. It enhances data encryption through the Temporal Key Integrity Protocol (TKIP) which is a 128-bit per-packet key, meaning that it dynamically generates a new key for each packet. WPA also includes a message integrity check feature to prevent data packets from being hampered with. Only authorized network users can access the wireless network.

Wireless - Security	
SSID	Tenda_F20BC0
Security Mode	WPA - PSK
Cipher Type	<input checked="" type="radio"/> AES <input type="radio"/> TKIP <input type="radio"/> TKIP&AES
Security Key	12345678
Key Renewal Interval	3600 seconds

- Cipher Type: Select AES (advanced encryption standard) or TKIP (temporary key integrity protocol).
- Security Key: Enter a security key, which must be between 8-63 ASCII characters long or 64 HEX characters long.
- Key Renewal Interval: Specify a valid time interval for the key to be updated. Do not change the default value unless necessary.

6.2.3 WPA2-PSK

The later WPA2 protocol features compliance with the full IEEE 802.11i standard and uses Advanced Encryption Standard (AES) in addition to TKIP encryption protocol to guarantee better security than that provided by WEP or WPA.

Wireless - Security	
SSID	Tenda_F20BC0
Security Mode	WPA2 - PSK
Cipher Type	<input checked="" type="radio"/> AES <input type="radio"/> TKIP <input type="radio"/> TKIP&AES
Security Key	12345678
Key Renewal Interval	3600 seconds

- Cipher Type: Select AES (advanced encryption standard), TKIP (temporary key integrity protocol) or TKIP &AES.
- Security Key: Enter a security key, which must be between 8-63 ASCII characters long or 64 HEX characters long.
- Key Renewal Interval: Specify a valid time interval for the key to be updated. Do not change the default value unless necessary.

6.3 Wireless Access Control

The MAC-based Wireless Access Control feature can be used to allow or disallow clients to connect to your wireless network.

Wireless Access Control

SSID Tenda_F20BC0

Wireless Access Control

MAC Address

00 11 44 55 55 88

00:11:44:55:55:88

- **Wireless Access Control:** To deactivate the Wireless Access Control feature, select "Disable" means; to only allow wireless clients included in list to connect to your wireless network, select "Allow"; to only block wireless clients included in list to connect to your wireless network, select "Deny".
- **MAC Address:** Enter the MAC address of a wireless client.
- **Add:** Click to add a new MAC to the list.
- **MAC Address List:** Displays added MAC address entries. You can add new entries or delete existing entries according to your needs.

Example 1: To allow only the PC at the MAC address of 00:11:44:55:55:88 to connect to your wireless network, do as follows:

Wireless Access Control

SSID Tenda_F20BC0

Wireless Access Control

MAC Address Action

00	11	44	55	55	88	<input type="button" value="Add"/>
00:11:44:55:55:88						<input type="button" value="Delete"/>

Step1. Select "Allow" from the corresponding drop-down menu.

Step2. Enter 00:11:44:55:55:88 in the MAC address box and click "Add".

Step3. Click the "**Save**" button to save your settings. Now only the wireless client at the MAC address of 00:11:44:55:55:88 can connect to the Device. To add more wireless MAC addresses, simply repeat the above steps.

Example 2: To prevent the PC at the MAC address of 00:c2:a5:67:d4:23 from connecting to your wireless network

Wireless Access Control

SSID Tenda_F20BC0

Wireless Access Control

MAC Address

<input type="text" value="00"/>	<input type="text" value="c2"/>	<input type="text" value="a5"/>	<input type="text" value="67"/>	<input type="text" value="d4"/>	<input type="text" value="23"/>	<input type="button" value="Add"/>
---------------------------------	---------------------------------	---------------------------------	---------------------------------	---------------------------------	---------------------------------	------------------------------------

Refer to example 1.

6.4 WPS Settings

Wi-Fi Protected Setup makes it easy for home users who know little of wireless security to establish a home network, as well as to add new devices to an existing network without entering long passphrases or configuring complicated settings. Simply enter a PIN code or press the software PBC button or hardware WPS button (if any) and a secure wireless connection is established.

SSID	Tenda_F20BC0
AP PIN Code	27540350
WPS Settings	<input type="radio"/> Disable <input checked="" type="radio"/> Enable
WPS Mode	<input checked="" type="radio"/> PBC <input type="radio"/> PIN

Note: 1. The WPS can be used only when security mode: None, WPA2-PSK or Mixed WPA/WPA2-PSK and cipher type: AES or TKIP&AES are selected.

2. When connected to the Powerline AP via WPS encryption, SSID and security key will change randomly; security mode will change to Mixed WPA/WPA2-PSK automatically and cipher type will change to TKIP&AES automatically.

- SSID: Displays Device's current SSID.
- AP PIN Code: Displays Device's PIN code; this option is not configurable.
- WPS: Select to enable/disable the WPS feature. This option is disabled by default.
- WPS Mode: Select PBC (Push-Button Configuration) or PIN.
- PBC: To use the PBC option, select it and click "Save"; or press the WPS hardware button on Device's back panel for about one second while enabling WPS >PBC on the intended client simultaneously.

Operation Instructions:

Press the WPS button for one second and the WPS LED starts blinking. Within 2 minutes thereafter, enable WPS >PBC on the intended wireless

client. When authentication between Device and the intended wireless client completes, the WPS LED will display a solid light, which indicates the wireless client has connected to the Device successfully. Repeat steps mentioned above if you want to connect more wireless clients to the Device.

- **PIN:** To use this option, you must know the wireless client's PIN code and enter it in the corresponding field on your device while using the same PIN code on client side for connection.
- **Reset OOB:** When clicked, Device's wireless settings including SSID, security mode and WPS, etc will be reset to factory default values.

△ **Note:**

1. To use the WPS encryption, the wireless adapter must be WPS-capable.

2. Upon successful WPS connection, the Device's SSID and security key will change randomly; security mode will change to Mixed WPA/WPA2-PSK automatically and cipher type will change to TKIP&AES automatically.

6.5 Connection Status

This section displays the info of connected wireless clients including MAC addresses and frequency width.

Connection Status

This section displays client info.

Hosts Connected Currently:

ID	MAC Address	Bandwidth
1	C8:3A:35:C3:00:E5	20M

- **MAC Address:** Displays MAC addresses of wireless clients connected to the Device.
- **Bandwidth:** Displays channel bandwidth used by currently connected hosts (wireless clients).

 **Note:**

The bandwidth here refers to the channel bandwidth instead of wireless connection rate.

Chapter 7 PLC Settings

This section presents you how to config and manage the PLC features of the Device using the Web UI.

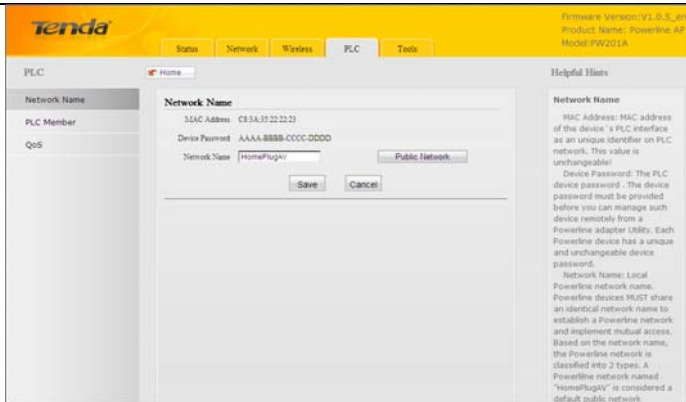

7.1 PLC Network Settings

To change Device's network name, click "Network Name".

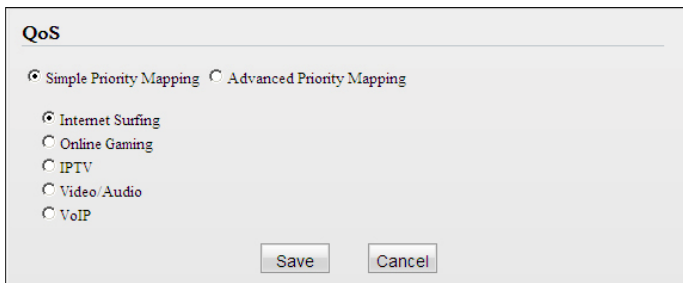

- **MAC Address:** Displays the MAC address of Device's PLC interface (equivalent to the identifier on PLC network). This value is unchangeable!

➤ **Device Password:** Displays Device's password. Each Tenda Powerline device has a factory preset, unique password for authentication on remote management. The device password can also be seen from the label attached to Device's bottom.

For example, assuming that a Powerline network has been established between a Tenda P200 (Powerline Adapter) and the PW201A and your PC is connected to the P200, then when you try to manage the PW201A remotely from your PC using the P200 utility, a dialog box will pop up and ask you to enter the PW201A's device password. You must enter a correct device password there before you can manage the PW201A's PLC features.

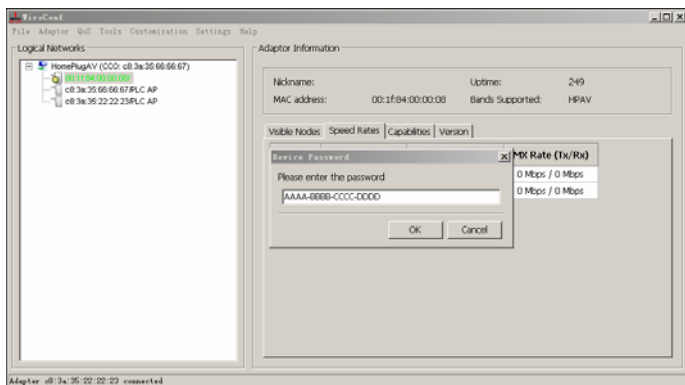

➤ **Network Name:** Displays Device's network name. Powerline devices MUST share an identical network name to establish a Powerline network. Based on the network name, the Powerline network is classified into 2 types. A Powerline network named "HomePlugAV" is

considered a public network otherwise identified as a private network. This field displays "HomePlugAV" if Device is currently a public network otherwise displays "Unkown".

- **Default Network:** Click to reset Device's network name to the default of "HomePlugAV".

7.2 PLC Member Settings

This section allows you to view information of other PLC devices on the same Powerline network. You can also perform authentication on these devices by entering their MAC addresses and Device Passwords as well as view the authentication results.

PLC Member

PLC Device List

Select	ID	MAC Address	Tx Rate	Rx Rate
--------	----	-------------	---------	---------

Add PLC Device

MAC Address

Device Password

PLC Authentication List

ID	MAC Address	Device Password	Authentication Status	Edit
----	-------------	-----------------	-----------------------	------

7.2.1 PLC Device List

This section displays the MAC addresses and connection rates of other PLC devices that are connected to the Device. The PLC devices could be Powerline adapters, Powerline APs or Powerline routers.

PLC Member				
PLC Device List				
Select	ID	MAC Address	Tx Rate	Rx Rate
<input type="checkbox"/>	1	c8:3a:35:00:09:f1	56Mbps	23Mbps

- **PLC Device List:** Displays only Tenda Powerline devices that are on the same Powerline network. The PLC devices use MAC address to identify each other.
- **MAC Address:** Displays MAC addresses of PLC devices on the Powerline network. Each PLC device has a unique MAC address that works as the unique identifier on the Powerline network.
- **Tx Rate:** Displays PLC Tx (transmit) rate.
- **Rx Rate:** Displays PLC Rx (receive) rate.
- **Select:** Click the "Select" radio button to automatically add corresponding PLC device's MAC address to the MAC address field of "Add PLC Device".
- **Scan:** Click to update current PLC device list manually. To automatically update the list, simply reload the web page.

7.2.2 Add PLC Device

To add a PLC device to the PLC Authentication List, simply enter its MAC address and Device Password.

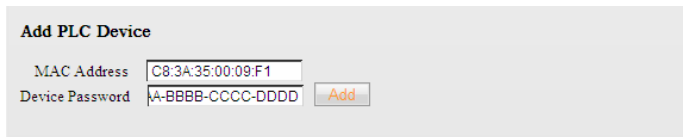

Add PLC Device

MAC Address

Device Password

- **MAC Address:** Enter the MAC address of the PLC device to add or click the "Select" button to add the corresponding PLC device's MAC address automatically.
- **Device Password:** Enter the correct Device Password of the PLC device to add. The Device Password is printed, in the format of XXXX-XXXX-XXXX-XXXX (where X represents a capital English letter), on the label on the back of the Device.
- **Add:** Click to add corresponding PLC device to the "PLC Authentication List".

7.2.3 PLC Authentication List

This section displays added PLC devices and their authentication status. A wrong Device Password or MAC address will lead to authentication failure.

ID	MAC Address	Device Password	Authentication Status	Edit
1	c8:3a:35:00:09:f1	LTSN-MRIY-RCSS-YXQU	Authentication is successful	Delete
2	c8:3a:35:66:2f:88	LSTB-MRIY-SSYY-YCDS	Authentication failed	Delete

- **MAC Address:** Displays the MAC address entered when you add the PLC device.
- **Device Password:** Displays the Device Password entered when you add the PLC device.
- **Authentication Status:** Displays whether authentication has passed. To pass authentication, below requirements must be met: a). You must provide a correct MAC address and a correct Device Password for the intended PLC device; b). The intended PLC device must be currently connected with the Device. Otherwise, authentication fails. As seen in above screenshot, the first PLC device passed authentication because both its MAC address and Device Password entered are correct, and it is currently on the Powerline network. While the second PLC device failed because its Device Password entered is wrong. However, the first PLC device will not be able to pass authentication if you disconnect it from the current Powerline network (say, disconnect it from power supply or change its network name).
- Click "Delete" to delete a corresponding entry.

 Note:

1. When adding a repeated MAC address to the PLC Authentication List, you will be asked whether to update the existing entry.
2. Up to 8 authentication entries can be included.
3. The more authentication entries you add, the longer it takes to authenticate the Powerline devices, open or refresh the web page.
4. The PLC authentication feature works only on Tenda Powerline devices. Authentication on Powerline devices of other brands will fail whether a correct MAC address and a correct Device Password are provided or not.

7.3 PLC QoS Settings

QoS prioritizes bandwidth-intensive and latency-sensitive applications and services such as Internet/IPTV/audio/video/VOIP/online game services, ensuring high reliability and least latency in transmission of these real-time data.

The Device provides 4 priority levels: Highest, High, Medium and Low. It is advisable to assign the highest priority to essential data traffic.

Two QoS priority mapping types are provided: Simple Priority Mapping and Advanced Priority Mapping.

7.3.1 Simple Priority Mapping

This section allows you to quickly set any option among Surfing, IPTV, Video/Audio, VOIP and Games to the highest priority. By default, Surfing is prioritized.

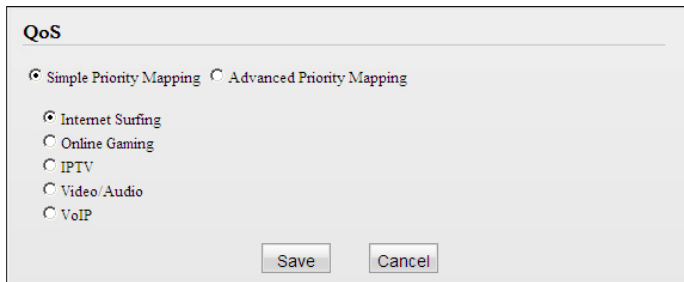

- Surfing: Select it to prioritize HTTP data and improve Internet surfing experience. Note: Applications/services such as web video and web gaming, etc, which use HTTP protocol, will also be prioritized.
- Games: Select it to prioritize and smooth gaming traffic. As there are too many games to be all included in the device QoS engine. So please note that not all gaming traffic can be processed with precedence.
- IPTV : Select it to prioritize IPTV data. The device supports RTSP-compliant IPTV data prioritization. However, some IPTV devices from other manufacturers may not adopt the RTSP protocol. So if the device does not prioritize IPTV data from your IPTV device, consult your manufacturer for the protocol and port info and send it to our

technical staff so that we can include it in later version for better compatibility.

- Video/Audio: Select it to prioritize video/audio data streaming.
- VoIP: Select it to prioritize VoIP data. The device supports SIP-compliant and H.323-compliant data prioritization. However, some VoIP devices from other manufacturers may use different protocols other than the above 2. So if the device does not prioritize VoIP data from your VoIP device, consult your manufacturer for the protocol and port info and send it to our technical staff so that we can include it in later version for better compatibility.

7.3.2 Advanced Priority Mapping

The Advanced Priority Mapping allows you to setup IP /MAC based priority policy used by the Powerline AP on a congested Powerline network.

QoS

Simple Priority Mapping Advanced Priority Mapping

MAC Based Priority

MAC Address	Priority
1. <input type="text"/>	Highest ▼
2. <input type="text"/>	Highest ▼
3. <input type="text"/>	Highest ▼
4. <input type="text"/>	Highest ▼

IP Based Priority

IP Address	Priority
1. <input type="text"/>	Highest ▼
2. <input type="text"/>	Highest ▼
3. <input type="text"/>	Highest ▼
4. <input type="text"/>	Highest ▼

- **MAC Based Priority:** Specify priority based on PC's MAC address.
- **MAC Address:** Enter the MAC address of the intended PC.
- **IP Based Priority:** Specify priority based on PC's IP address.
- **IP Address:** Enter the IP address of the intended PC.
- **Priority:** Specify a priority level for the designated PC.

Example: To set the PC at the MAC address of 00:90:4C:12:34:56 to lowest priority and the PC at the IP address of 192.168.0.123 to highest priority, config Device as seen below:

QoS

Simple Priority Mapping Advanced Priority Mapping

MAC Based Priority

MAC Address	Priority
1. 00:90:4C:12:34:56	Low
2. <input type="text"/>	Highest
3. <input type="text"/>	Highest
4. <input type="text"/>	Highest

IP Based Priority

IP Address	Priority
1. 192.168.0.123	Highest
2. <input type="text"/>	Highest
3. <input type="text"/>	Highest
4. <input type="text"/>	Highest

 Note:

1. The Simple Priority Mapping feature and Advanced Priority Mapping feature can be only used alone instead of concurrently.
2. The QoS feature does not increase your existing bandwidth. It only prioritizes specified data over your existing bandwidth.
3. Advantages of the QoS feature are typically seen on congested networks. Normally, Powerline network is not confronted with congestion as Powerline transmission rate reaches up to 200M while ADSL Internet connection rate is only 12M at most and yet shared by multiple users. So, you may not experience obviously tremendous benefits from your QoS settings if you are enjoying a smooth network.

However the QoS feature does bring you more or less benefits, they are just not as tremendous as in a congested network.

Chapter 8 Tools

8.1 Firmware Update

Firmware upgrade is released periodically to improve the functionality of your Device and also to add new features. If you run into a problem with a specific feature of the Device, log on to our website (www.tendacn.com) to download the latest firmware to update your Device.

Firmware Update

Use this section to update your device firmware for better functionalities or new features.

Select a Firmware File:

Current Firmware Version: V1.0.5_en; Release Date: Sep 3 2012

Note: DO NOT power off the device while upgrade is in process, otherwise it may be permanently damaged.

1. Click "Browse" to locate and select the firmware.

2. Click "Update" to upgrade your firmware. Do not disconnect Device from the management PC (the PC you use to configure the Device) or power supply while upgrade is in process; otherwise, Device may be permanently damaged. Device will restart automatically when upgrade completes.

8.2 Backup & Restore Settings

This section allows you to backup current settings or to restore the previous settings configured on the Device.

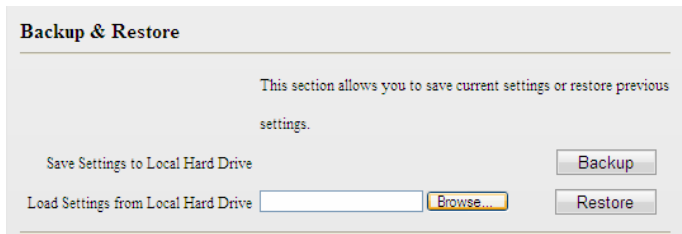

To backup settings

1. Once you have configured the device the way you want it, you can save these settings to a configuration file on your local hard drive that can later be imported to your device in case that the device is restored to factory default settings.

Simply click the "Backup" button and then "OK" on appearing window.

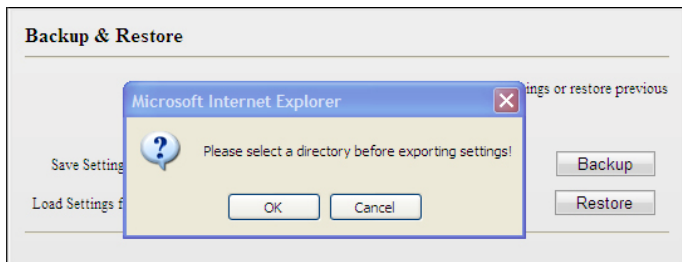

2. Click "Save" on the "File Download" window.

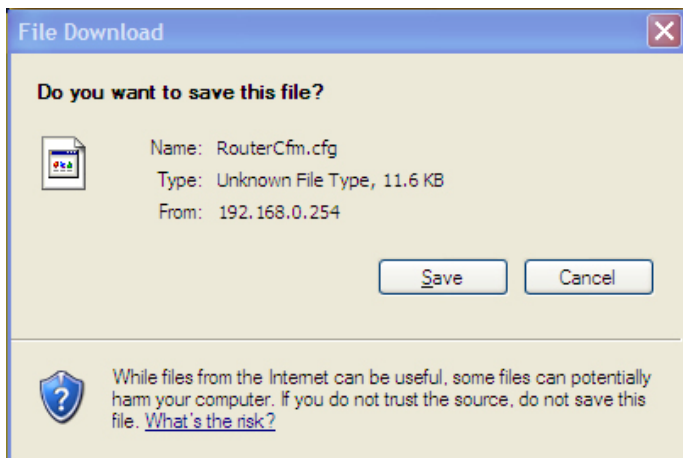

3. Specify a directory to save settings on your local hardware and click "Save".

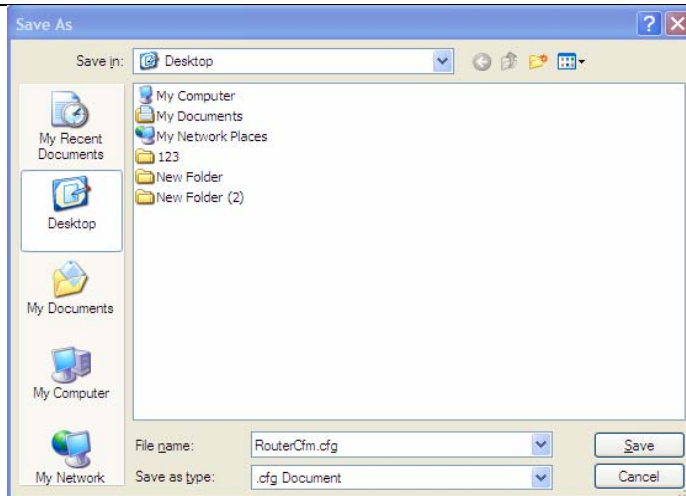

To restore settings

1. Click the "Browse" button to open "Choose file" window.

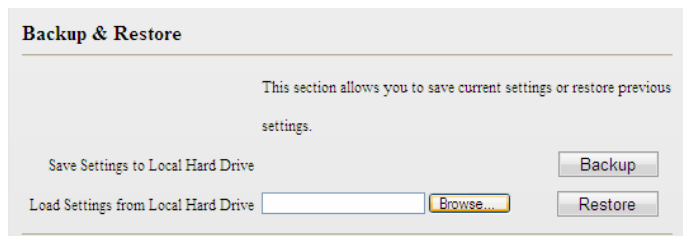

2. Select a configuration file that is saved previously to your local hard drive and click "Open".

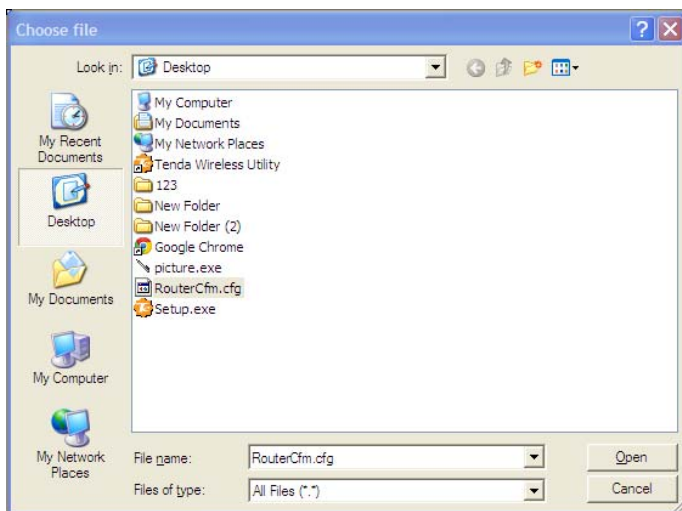

3. Click the "Restore" button to reset your device to previous settings.

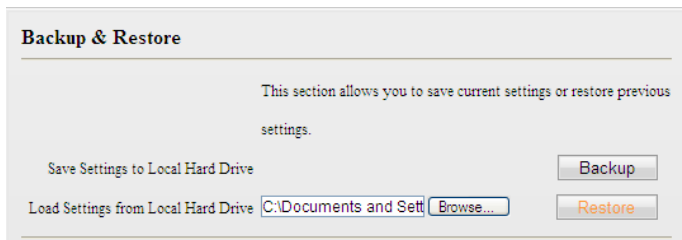

8.3. Restore to Factory Default Settings

Click the "Restore to Factory Default" button to reset Device to factory default settings.



Factory Default Settings:

User Name: admin

Password: admin

IP Address: 192.168.0.254

Subnet mask: Enter 255.255.255.0.

⚠ Note:

1. Device will restart automatically after reset.
2. You can also reset Device by pressing the WPS/RST button on its back panel for 6-10 seconds. When wireless LED and WPS LED display a

blinking light, it indicates that Device is successfully reset to factory default settings.

8.4 Change Password

This section allows you to change login password and user name for accessing Device's Web-based utility.

Change Password

Note: User name and password can only include letters, numbers or underscore!

New User Name
(User name should consist of 1-14 characters!)

New Password
(Password should consist of 3-12characters!)

Confirm New Password

- New User Name: Enter a new user name.
- New Password: Enter a new password.
- Confirm New Password: Re-enter the new password for confirmation.

Click "Save" and your settings will be activated.

 Note:

1. For security purpose, it is highly recommended that you change Device's default login password.
2. If you unfortunately forget the new password/user name, press the hardware WPS/RST button for 6-10 seconds to reset Device.

8.5 Syslog

The Syslog option allows you to view all events that occur upon system startup.

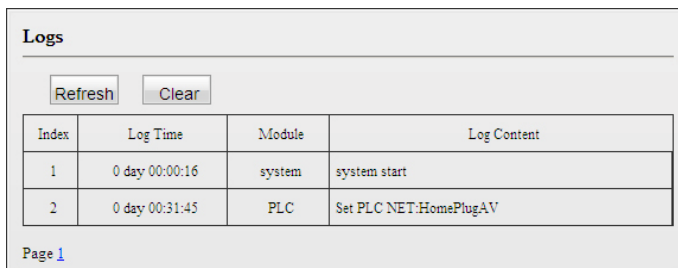

The screenshot shows a web interface titled "Logs". At the top, there are two buttons: "Refresh" and "Clear". Below these buttons is a table with four columns: "Index", "Log Time", "Module", and "Log Content". The table contains two rows of data. The first row shows index 1, log time "0 day 00:00:16", module "system", and log content "system start". The second row shows index 2, log time "0 day 00:31:45", module "PLC", and log content "Set PLC NET:HomePlugAV". Below the table, it says "Page 1".

Index	Log Time	Module	Log Content
1	0 day 00:00:16	system	system start
2	0 day 00:31:45	PLC	Set PLC NET:HomePlugAV

- Index: Displays log ID.
- **Log Time:** Displays system uptime when log is made. As seen in the screenshot above, at system uptime of "0 day 00:31:45", Device's network name is changed to "HomePlugAV".
- Module: Displays the functional module of a current log entry. As seen in the screenshot above, Device's network name change is implemented in the PLC functional module.
- Log Content: Briefly describes an event occurred on the Device.

- Refresh: Click to update current logs.
- Clear: Click to remove all logs.

8.6 Reboot

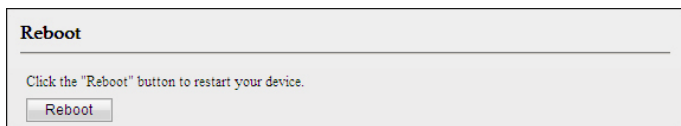

- Reboot: Click to restart Device.

Note:

1. All connections will be disconnected during reboot.
2. The reboot process lasts tens of seconds. When it completes system will be redirected to home page automatically.

Chapter 9 Pair Button

The Device provides 128-bit AES encryption method. This section presents how to use the Pair hardware button to quickly create a secure Powerline network.

2 or more Tenda Powerline devices under a single electricity meter will interconnect to create an unencrypted public network automatically using the same network name of HomePlugAV.

To create an encrypted private connection between 2 Tenda Powerline devices, do as follows (Here we use a Tenda P200 and a Tenda PW201A for demonstration):

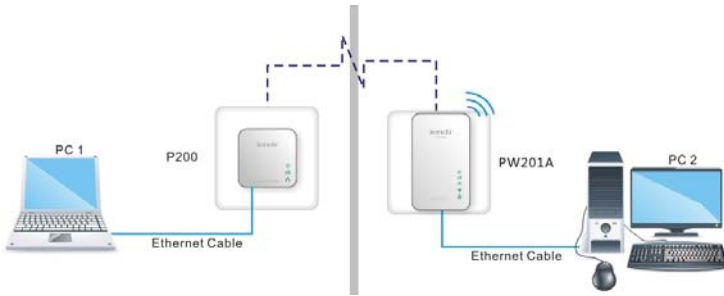

1. Press the Pair button on P200 for 2-3 seconds and then release it. The Power LED on P200 starts blinking, which indicates the P200 is ready for pair auto-negotiation.

2. Within 2 minutes upon releasing the P200's Pair button, press the Pair button on PW201A for 1-3 seconds and then release it. The PLC LED

on the PW201A starts blinking, which indicates the PW201A is ready for pair auto-negotiation..

3. Observe the two PLC device's LED status. When the Power LED displays a solid light and the PLC LED blinks rapidly, it indicates an encrypted private Powerline network is successfully created.

How to add more Powerline devices to the existing private network

Now that the PW201A (say PW201A-1) and P200 has created a network, say Network1, and you're trying to add a second PW201A (say PW201A-2) to this network, do as follows:

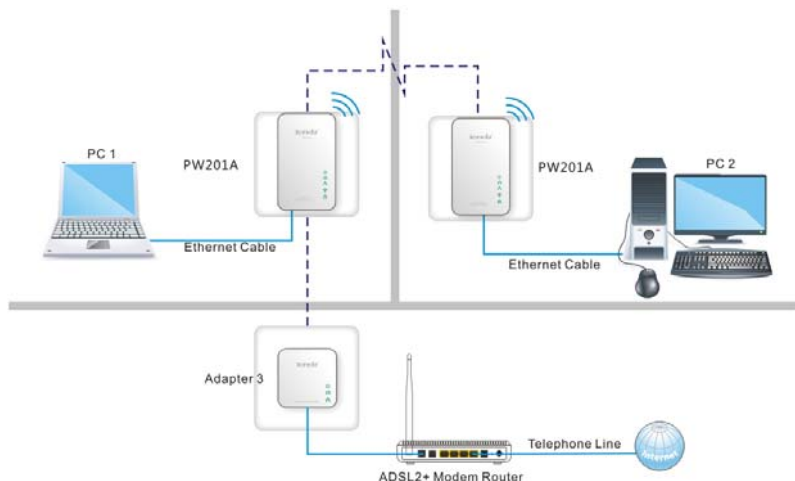

1. Press the Pair button on PW201A-2 for 1-3 seconds and then release it. When the PLC LED on the PW201A-2 starts blinking, it indicates this PW201A-2 is searching for available networks.

2. Within 2 minutes upon releasing PW201A-2's Pair button, press the Pair button on either P200 or PW201A-1 to start pairing.

3. Observe all Powerline device's LED status. When the Power LED displays a solid light and the PLC LED concurrently blinks rapidly, it indicates the PW201A-2 has been successfully connected to the existing Network 1.

To disconnect a Powerline device from the existing Powerline network, do as follows:

As mentioned above, one P200 and two PW201A devices have interconnected on a private Powerline network. If you want to disconnect PW201A-1 from the network, press the Pair button on PW201A-1 for over 6 seconds and then release it. When the Power LED on the PW201A-1 goes off, it indicates the PW201A-1 has left Network 1.

Appendix 1 FAQs

1. Q: What is Powerline networking?

A: Powerline technology upgrades your existing electric wiring, enabling transmission of both network data and electric power in a single power line at a high speed of up to 200Mbps, low cost and with better stability while without new wires required.

2. Q: Can a Powerline AP be used alone (without a PLC adapter)?

A: Yes. However, when used alone (without a Powerline adapter), it functions only as a wireless AP instead of a Powerline wireless AP. Thus, to utilize the PLC feature, you must have at least one PLC adapter, say, the Tenda P200. Simply connect the Tenda P200 Powerline adapter to one of the LAN ports on an Internet-enabled broadband router and Plug the PW201A into another electrical outlet under the same electric meter as the Powerline adapter (say, P200); then PCs connected to the PW201A wirelessly or using Ethernet cables are able access Internet.

3. Q: Can a Powerline AP access Internet immediately after plugged into a wall outlet?

A: No. There are two ways to enable clients connected to a Powerline AP, say, PW201A, to access Internet. A. Connect a second PW201A or another Tenda Powerline device to an Internet-enabled broadband router. With a Powerline connection established between the two involved

Powerline devices, clients connected wirelessly to the PW201A are able to access Internet. B. Simply connect the PW201A to an Internet-enabled broadband router using an Ethernet cable. And clients connected wirelessly to the PW201A will be able to access Internet.

4. Q: Do I need to install a utility to use the device?

A: No. The device is a plug-&-play Powerline device. Two Powerline devices connected to the same electricity meter are able to interconnect automatically, no configuration required. Yet, there is still an included Web based utility for configuring advanced features.

5. Q: I want to access Internet and manage the PLC AP concurrently from my PC. What should I do?

A: First, set your PC's IP address to "192.168.0.x" where x represents any integer between 2 and 253. Second, Launch a web browser and access the Device's web utility. Third, enter the LAN configuration screen and change the Device's LAN IP to an IP address that is on the same IP net segment as the LAN IP of an Internet-enabled broadband router (note it down for future use). Fourth, set your PC to "Obtain an IP address automatically". Now you can access Internet while managing the Device.

6. Q: I have installed two PW201A devices under a single electric meter. How am I supposed to manage them?

A: By default, the two PW201A devices cannot be managed concurrently as both share the same IP address of "192.168.0.254". However, below steps may help:

- a) Disconnect either PW201A from the power supply first;
- b). Access the connected PW201A's web utility to change its IP address to a different one such as "192.168.0.253";
- c). Connect the disconnected PW201A back to the power supply. Now, you can manage both PW201A devices concurrently.

7. Q: How many Powerline devices at most can be included under a single electricity meter (on a single Powerline network)?

A: A single Powerline network may include up to 9 Powerline devices, be it Powerline adapter, Powerline AP or Powerline router. However you can create multiple private networks.

8. Q: What is the maximum transfer distance of a Powerline device?

A: Up to 300m can be reached with least interference. However transmission rate decreases gradually beyond 100m.

9. Q: Can Powerline devices of different brands communicate with each other?

A: Yes. This Tenda Powerline device complies with HomePlug AV standard and thus can communicate with other manufacturers' HomePlug AV-compliant Powerline devices.

10. Q: Will the Powerline network get disconnected upon blackout?

A: Yes. The Powerline network delivers data over electric wiring via electricity.

11. Q: Would it be dangerous to use the Powerline device in a thunderstorm?

A: The device's internal thunder-/lightning-proof facility protects PC or other devices connected against any potential and harmful thunder or lightning attacks even when the building where the Powerline lies is unfortunately thunderstorm-struck.

Appendix 2 Technical Specification

Hardware	
Standards	RJ45: IEEE 802.3, IEEE 802.3u PLC : HomePlugAV WIFI: IEEE802.11n, IEEE 802.11g, IEEE 802.11b
Transmission Distance	300 meters over Powerline wire
Max devices on Private Network	Up to 9
Compatibility	HomePlugAV
Transmission Rate	PLC : 200Mbps RJ45 : 10/100Mbps WIFI : 300Mbps
Interface & Speed	1*RJ45 10/100Mbps
Button	1*WPS/Reset button 1*PAIR button
LED	1* Power LED, 1* PLC LED, 1* Ethernet LED, 1* Wireless LED and 1* WPS LED
Input Power	AC 100V-240V 50/60Hz

Dimension	L (mm)	94
	W (mm)	60
	H (mm)	48
Security	PLC: 128-bit AES encryption WIFI : WEP, WPA-PSK and WPA2-PSK	
Operating Temperature	0°C~40°C	
Storage Temperature	-40°C~70°C	
Operating Humidity	10% ~ 90% RH Non-condensing	
Storage Humidity	5% ~ 90% RH Non-condensing	

Appendix 3 Safety and Emission Statement

CE Mark Warning

This is a Class B product. In a domestic environment, this product may cause radio interference, in which case the user may be required to take adequate measures. This device complies with EU 1999/5/EC.

NOTE: (1) The manufacturer is not responsible for any radio or TV interference caused by unauthorized modifications to this equipment. (2) To avoid unnecessary radiation interference, it is recommended to use a shielded RJ45 cable.

FCC Statement

This device complies with Part 15 of the FCC Rules. Operation is subject to the following two conditions: (1) This device may not cause harmful interference, and (2) this device must accept any interference received, including interference that may cause undesired operation.

This equipment has been tested and found to comply with the limits for a Class B digital device, pursuant to Part 15 of the FCC Rules. These limits are designed to provide reasonable protection against harmful interference in a residential installation. This equipment generates, uses and can radiate radio frequency energy and, if not installed and used in accordance with the instructions, may cause harmful interference to radio communications. However, there is no guarantee that interference will not occur in a particular installation. If this equipment does cause harmful interference to radio or television reception, which can be determined by turning the equipment off and on, the user is encouraged to try to correct the interference by one of the following measures:

- Reorient or relocate the receiving antenna.
- Increase the separation between the equipment and receiver.
- Connect the equipment into an outlet on a circuit different from that to which the receiver is connected.
- Consult the dealer or an experienced radio/TV technician for help.

FCC Caution: Any changes or modifications not expressly approved by the party responsible for compliance could void the user's authority to operate this equipment.

This transmitter must not be co-located or operating in conjunction with any other antenna or transmitter.

The manufacturer is not responsible for any radio or TV interference caused by unauthorized modifications to this equipment.

Radiation Exposure Statement

This equipment complies with FCC radiation exposure limits set forth for an uncontrolled environment. This equipment should be installed and operated with minimum distance 20cm between the radiator & your body.