

# Car Multimedia System

— 3D menu

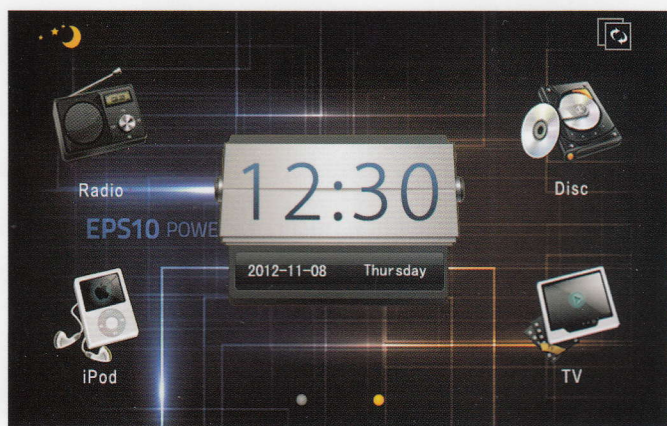

## OPERATION MANUAL

Digital & Clock Time User Interface (Two Sets)

## **Warning**

Dear customer,

Thanks for your purchase! Please read this manual carefully, and keep it for future reference.

## **Warning**

The disk must be clean. Please clean it if having dust.

The disk must be cleaned by soft cloth, then put the disk into the device. Otherwise, the dust will be taken into the machine and it affects the machine to insert and eject slowly or not insert and eject.

# CONTENTS

Notes on installation.....	3
Connection guide.....	4
Main menu.....	6
Special Features.....	9
VMCD&MP5.....	10
General setting.....	11
Radio mode .....	14
DVD/SD/USB operation mode.....	17
TV mode.....	19
Bluetooth mode.....	21
IPOD mode.....	23
AUX mode.....	24
GPS mode .....	25
System setup .....	32
Remote operation.....	38
Specification.....	39
Simple trouble shooting guide.....	40

# NOTES ON INSTALLATION

## Notes on installation

The unit is designed for 12-14vdc,negative ground operation system only.Before installing the unit,make sure your vehicles is connected to 12v-14v dc negative grounded electrical system.

The negative battery terminal must be disconnected before making connections,which can reduce damaging to the unit due to short circuit.

Be sure to connect the color coded leads correctly according to the diagram.Incorrect connection may cause the unit malfunction or damage the vehicle's electrical system.

Be sure to connect the speaker(-)leads to the speaker(-)terminal.never connect the left and right channel speaker cables each other or to the vehicle body.Do not block vents or radiator panels.blocking them will cause heat to build up inside any may result in fire.

After the completion of the installation and begin to operate the unit(including replacing the battery),please press the reset button(1) on the front panel with pointed objects(such as ball pen) to set the unit to initial status.



# CONNECTION GUIDE

## Connection Guide

### 1.57G Main Board Connection Guide

#### WIRING DIAGRAM

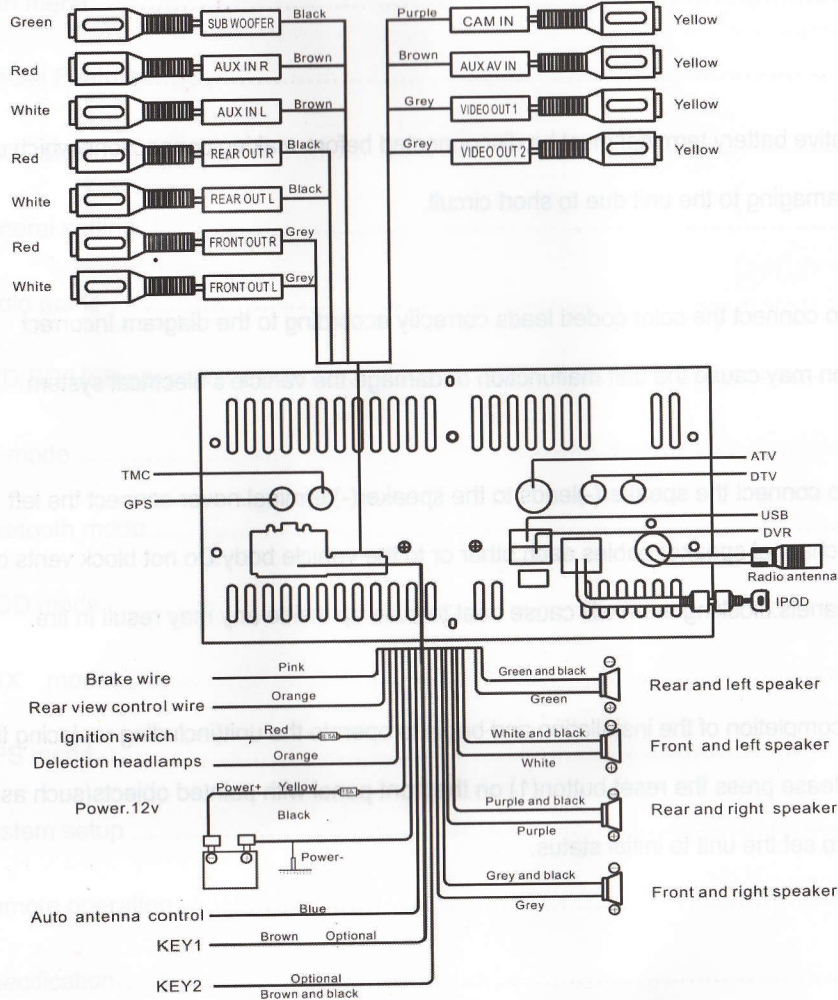

### 2.31G Main Board Connection Guide

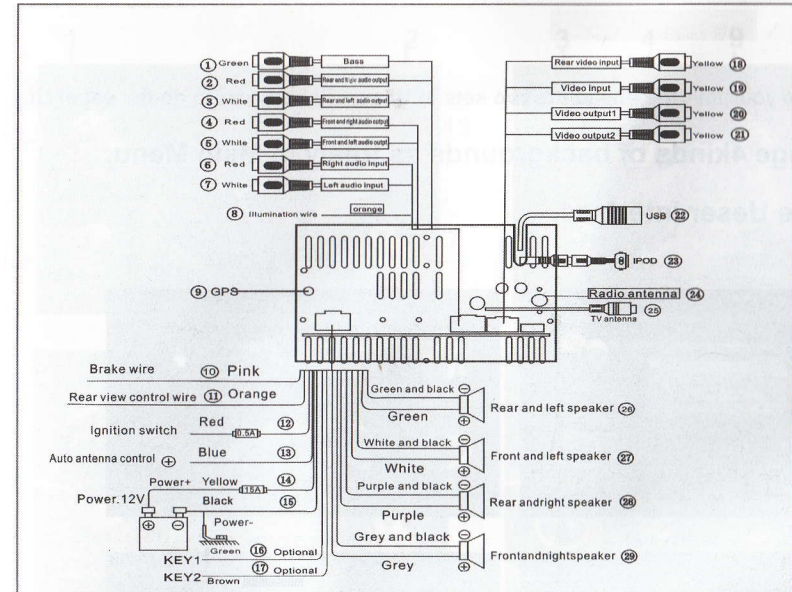

### 3. Indash--1DIN Connection

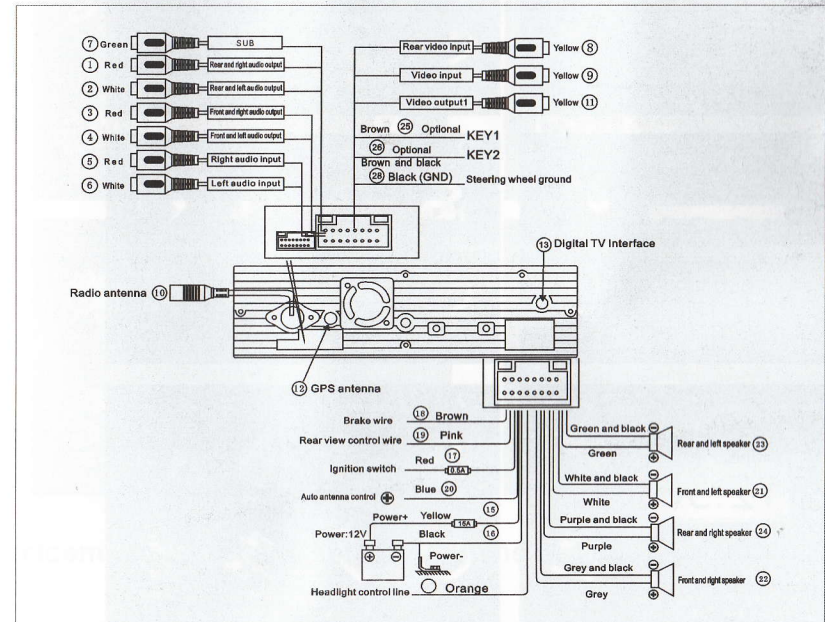



# BASIC OPERATION

## Main menu

( You can choose your favorite one in the two sets of UI,we will help you to do the set of UI.)

We can change 4kinds of backgrounds as freely in Main Menu.

### 1.Digital Time Ueser Interface.

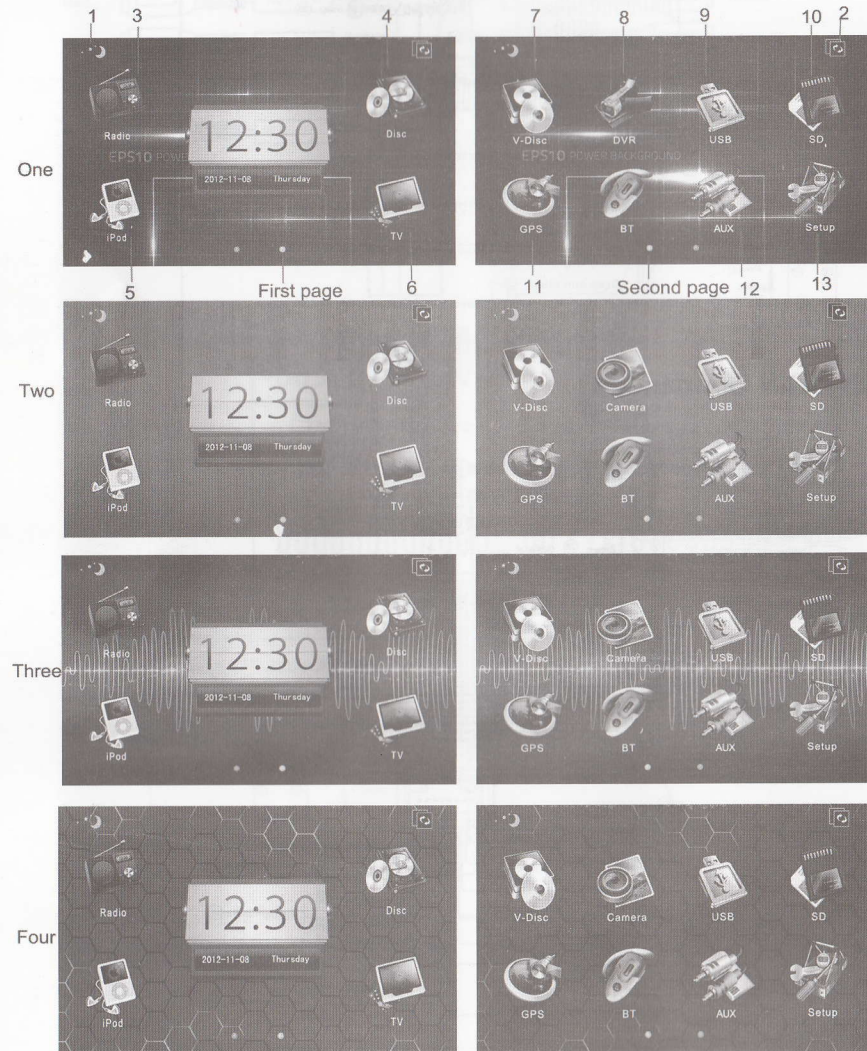

### 2.Clock Time Ueser Interface.

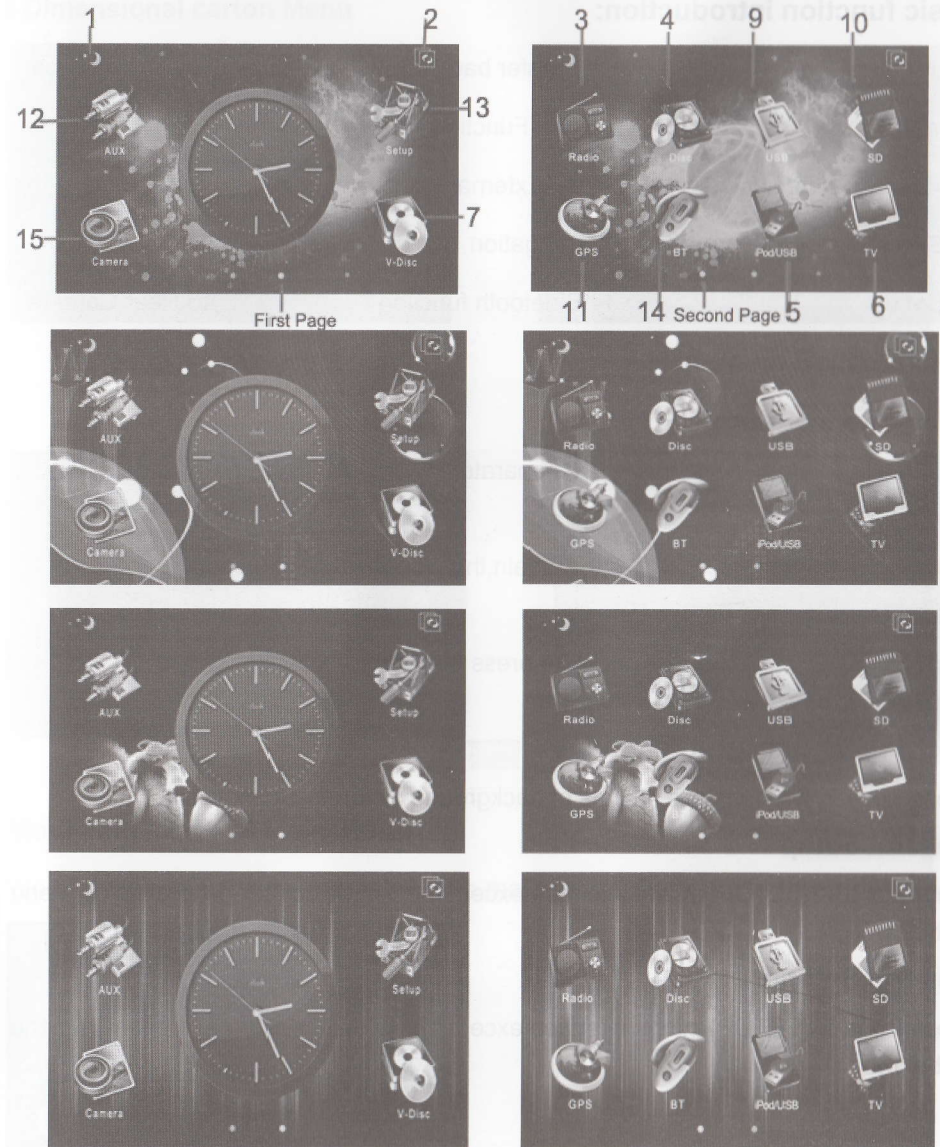

Welcome to select any sets of UI in the two sets of user interface!



# BASIC OPERATION

## Basic function introduction:

- |                             |                                   |                   |
|-----------------------------|-----------------------------------|-------------------|
| 1.Luminous                  | 2. Transfer background            | 3. Radio function |
| 4.Read Disc                 | 5. IPOD Function                  | 6.TV Function     |
| 7.V-Disc(Optional function) | 8.DVR External(Optional function) | 9.USB Card        |
| 10.SD card                  | 11.Navigation                     | 12.AUX IN         |
| 13.Set up                   | 14.Bluetooth function             | 15.Rear Camera    |
| 16.Time show                |                                   |                   |

## Enter into the mode

Touch 3-12 number icons button,can separately enter into the mode.

## Swith Screen

Press icons 1,The screen is off,press again,the screen will be reopened.

## Time Display

Such as 16.will show the time and date,press the icon,it will be off the area,press again,the screen will be reopened.

## Conversion background image

Press icons 2, it will replace 4 kinds of background pictures automatically.

## General Setup

Press icons 13[SETUP] in any interface except GPS,it will appear general setup menu as below.

## General Setting

Press icons 13[SETUP] in any interface except GPS,it will appear general setup menu as below.

# Special Features:

## 3 Dimensional carton Menu

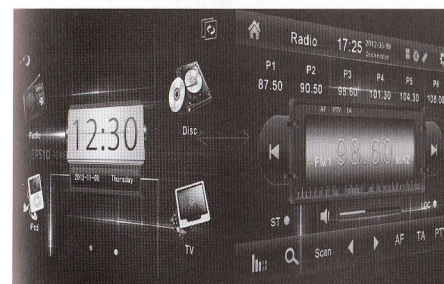

Left-right Reversal



Up-down Reversal



Up-down Reversal



Left-right Reversal

## Moveable Icons in Main Meun

We can move any icons as freely in the main menu. Design your desired style.

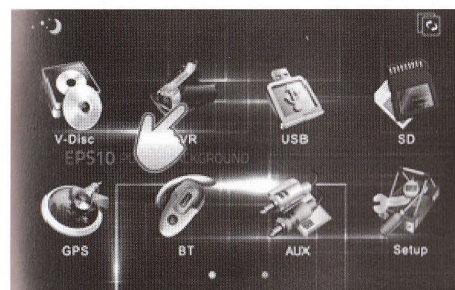



## Special features(Optional Function)

### VMCD Function(Optional)

Insert in U discs and SD card and enter in the interface of VMCD. Then we will put in CD discs. These musics which is inside CD discs will be copying in U discs and SD card.

External U discs and SD card.(Max:8G memory)



1.This CD is loading finished,It will be indicating"CD"



2.Clik on the touch-key "☐" Select the Compression ratio and burn any discs.

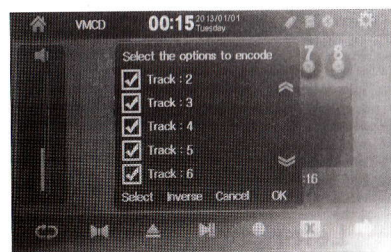

3.Choosing all of the music which is burning 4.If you want to stop to burn,you will click on inside CD disc, then pressing "OK".

the "☐". These discs will be burned finished It's disc icon will be showing red. You will select desired music inside any disc.

### MP5 Function

- 1.Support MP3, WMA, FLAC, APE, AAC mainstream music formats for broadcast.
- 2.Support RM, RMVB, ASF, AVI, MP4, 3 GP, MOV, FLV, MPE, MPG, MPEG, DAT all formats of videos to play,namely that the look, without conversion.

Support JPG, BMP, GIF, PNG, TIFF, PCX, ICO ect , different format images. At the same time,it is also support ing to rotating, preview and amplification the pictures

### General Setting

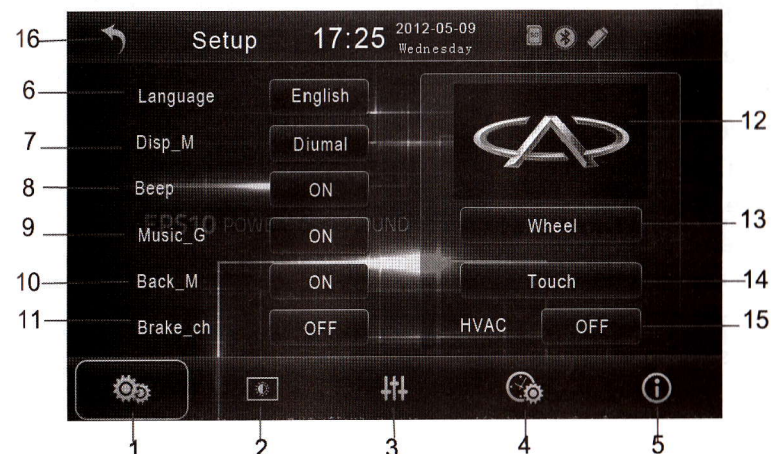

- |                            |                             |
|----------------------------|-----------------------------|
| 1. General                 | 4.time                      |
| 2. Display                 | 5.information               |
| 3.sound                    | 6.language                  |
| 7.Disp-M                   | 8. Key Sound                |
| 9.Music navigation setting | 10. Rear View Image setting |
| 11. Handbrake Test setting | 12.change logo              |
| 13. Steering Wheel setting | 14. Touch screen adjustment |
| 15.OFF                     | 16.Main menu button         |

Touch 1,Language button,can set the menu display language Chinese or English.

Touch 2,Key sound button,can set the key sound on or off.

Touch 3,music navigation,can set up the music or video is on or off when navigation

Touch 4,backlight mode,can choose Day or night mode.

Touch 5,rear view image,can set up the rear view image on or off

Touch6,steering wheel setting,can set up the steering wheel,details please check the steering wheel setting guide.

Touch7,touch screen adjustment

Touch8,handbrake test setting can set up the handbrake on or off.

### Steering wheel setting

#### Setup and use of steering wheel:

If your car with steering wheel control, please operate as follows:



1. Under the circumstance of power cut off, find the grounding wire of your car's steering wheel wires, (Note: some cars have three pieces of wires, others have two pieces), then, connect it to the grounding wire of three pieces of steering wheel wires drew forth from the main unit. If your car's steering wheel has three pieces of wires, connect the other two pieces of key wires to the rest two pieces of key wires drew forth from the main unit, you can connect them at will; if your car's steering wheel has two pieces of wire totally, you can connect the rest one to any piece of the rest two pieces of key wire drew forth from the main unit;



2. Supply the power to turn on the unit after you confirm the steering wheel connection wires all correct, press the setup button of upper right corner in the screen to enter setup menu;

3. Press the center of direction setup button in the top of setup menu, the steering wheel setup menu will bound out;

4. After steering wheel setup menu bound out, press text button firstly, you will see sample figure of A and B displayed in information box, this is the initial figure that the main unit get sample to car's steering wheel.

5. Then, press the following key "cancel" firstly to clear all keys. Note: you must press this key to clear all previous setting before every to change setting.

6. And then, you can make the keys learn. after you press the top function key, the information box will prompt "PLS PRESS KEY" to prompt user to press key of car's steering wheel that need to define. when you have pressed the key of car's steering

## Steering wheel setting

wheel, the information box will display the key figure that you pressed, that means the key has been got sample by main unit, then, you can learn the next key till finish all keys learning.

7. When complete the learning, you need to press "complete" to save the key you have learned and start steering wheel function, if you didn't press "apply" key after finished learning, before you will study will make invalid processing.

8. If you don't want it after finish learning, press "cancel" to cancel it, at the same time, close the steering wheel function.

9. If you think that some keys' sample figures are very close during learning and it's easy to mistake code, press exchange two wires, means exchange previous two pieces of wires from car steering wheel to unit drew forth. If the car's steering wheel just has one piece of wire, please connect the key wire of steering wheel to the other wire of unit, then return to the first step to learn.

10. Maybe there are several keys in car's steering wheel, you can define by yourself,

make the key function of steering wheel and key function in menu correspondence, and finish learning. You can ignore it if a key in menu but not in steering wheel, it won't influence normal use. You just need to learn the keys which are in steering wheel's OK.

11. You can also enter setup menu and press "cancel" to close steering wheel function after finish learning steering wheel. After closed the steering wheel will have no function. If you need to turn on steering wheel function, please return to the first step and re-learn to setup.



## Display Setup

Press the display mode right picture shows which has four kinds of mode to select:

Customize→Standard→Bright→Soft  
Press the right picture shows “color” “contrast” “brightness” to adjust the color, contrast and brightness of display screen at will separately.



## Voice Setup

Press “EQ mode” button of right picture shows which has five kinds of mode to adjust:

Standard→Rock→Popular→Jazz→Classical

Press “loudness” button of right picture shows to choose “turn on” or “turn off” the loudness. Press the left or right button of “treble” and “bass” you can adjust treble or bass by yourself.

Press car’s up, down, left, right button as right picture which can come to the adjustment to car’s front, back, left, right loudspeakers.

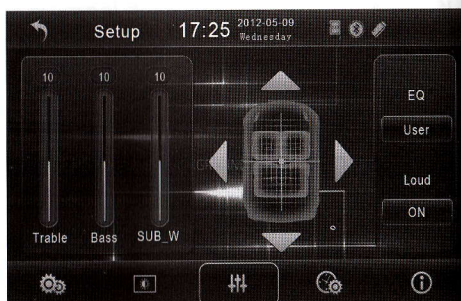

## Time Setup

Press time adjustment button and button to setup time and date.

Press time adjustment button to setup the time display is “12H” or “24H”.

Press date adjustment of right picture button and button to adjust date’s year, month, day. After finish the adjustment, Please 【Submission】 button and then exit the time setup menu.



## Edition Information

Press edition button, It will display the software’s edition information.

## Radio mode

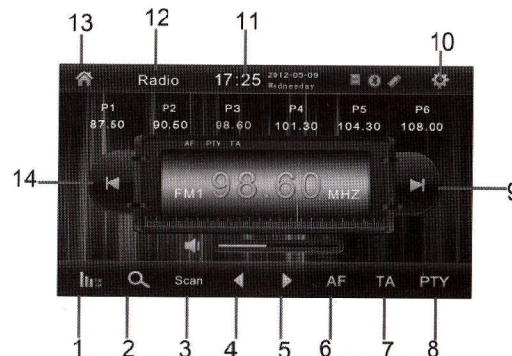

- |                             |                       |
|-----------------------------|-----------------------|
| 1. FM/AM                    | 7. PTY(RDS)(optional) |
| 2. Automatically scan radio | 8. BAND               |
| 3. Manual scan radio        | 9. video              |
| 3. Manual scan radio+       | 10. time              |
| 4. Manual scan radio-       | 12. radio             |
| 5. AF                       | 13. come back         |
| 6. TA(RDS)(optional)        | 14. BAND              |

## Automatically scan radio

Press 1 【auto-scan radio】 button, the unit will auto-scan radio, and save them into 1-6 button of each wave band.

## Scan

Press 2 【browse】 button, it auto-scan radio which is per-set in 1-6 button of each wave band, Every radio is displayed for 10 minutes.

## Loc

Press 3【Loc】button to setup remote or short-range scan radio mode of unit, if be setup in the short-range scan radio mode, the unit just receive local strong signal radio. If be setup in remote mode, it will receive local and remote radios.

### Stereo and single track switch:

Press 4【ST】button to setup stereo and single track receive radio mode.

### RDS(optional function)

If no RDS, or RDS is closed, 5-7 are Invalid.

A.【PTY】press 7 to choose your favorite programs style, 2 seconds later it will auto-scan program of the program style you setup.

B.【TA】after you press5, it will to auto-search RDS display radio.

C.【AF】AF function is setup to be open while being again, Press 5 to close or re-open it,

If the current signal is weak, within 50 seconds the unit will auto-search and display strong signal radio of same style.

### Radio mode

#### Manual Scan

Press 10【▶】and【◀】to choose different radio channels upward and downward. Long press 10【▶】and【◀】the unit will search the channels upward or downward automatically, It stops when a channel is searched.

#### Band switch:

Press 12【Band】to switch the radio band. The switching order is as follows:

FM1→FM2→FM3→AM1→AM2

#### Favorite radio channels:

When the unit receive a favorite channel, You can press one of the buttons in 1-6 keys for 2 seconds to save it in this button. Press 1-6key to play the preset channel. Show as picture 16.

#### Return to main menu:

Press 13 to return to the main menu

#### General setup:

Press 14 and the general setup menu shows up.

## DVD/SD/MMC/USB OPERATIONS

### DVD/SD/MMC/USB

#### operations

The unit will enter the DVD mode automatically when you put in a disc, if there is a disc inside the device, you can also enter the DVD mode by pressing DVD icon in the menu status, Enter/eject disc button.

1. Next
2. Previous
3. Stop
4. Play/ pause
5. Fast backward
6. Fast forward
7. MUTE
8. Menu display
9. OK
10. Direction key
11. Return to main menu
12. Status/time
13. General setup menu



## DVD/SD/MMC/USB OPERATIONS

- ◆Enter/eject  
Press button 1 control the enter or eject of the disc.
- ◆Play/pause  
Press button 2 to pause, press it again to recover normal play.
- ◆Stop:  
Press button 3 to stop playing, and press2 to play again.
- ◆Direction keys:  
Press button 4 P1 to enter the second page, 4 will display P2, press P2 to enter the Third page, button 4 display P3, Press P3 to enter the first page.
- ◆Menu play:



Press button 5 [menu] to enter the menu mode. [Note: the disc should be the VCD2.0, which supports the menu play or DVD].

◆Catalog function:

Press 6 [catalog] to choose various catalog of DVD.

◆Track function operation

Press 7 [track] to switch the set of left track, right track, mixed track, stereo, language (which should be supported by disc) freely.

◆ Reduce and enlarge:

Press 8 [reduce and enlarge] to reduce or enlarge the display picture by times, you may refer to remote control introduction.

◆Volume control:

The volumes increase/decrease if you press 9 volume button.

◆Repeat play:

Press button 11 to set the repeat mode and the repeat sequence is as follow:

All repeat→single repeat→repeat off

## DVD/SD/MMC/USB OPERATIONS

Note: the default mode is "all repeat".

◆ Fast forward / fast backward:

Press 12 and 13 button to play fast forward and fast backward. Press 12 continuously to play fast forward [ $\times 2 \times 4 \times 8 \times 20$ ]. Press button directly in fast forward or fast backward to return to the normal play.

◆Select program setup:

Press button 14 or 15 to choose next or previous.

◆Return to main menu:

Press button 16 to return to main menu.

◆General setup menu:

Press button 17 and the general setup menu shows up. For details, please refer to the general setup from page 9.

◆System button:

Press 19 [system] to choose NTSC or PAL system.

◆Random button:

Press 20 [random] to play programs in DVD randomly.

◆DVD setup:

Press 21 [setup] to setup DVD mode.

◆Title button:

Press 22 [title] to display the title catalog in DVD.

◆Display button:

Press 23 [display] to display play time and programs of DVD.

◆Scan:

Press 24 [scan] to scan Program in DVD.

◆Confirm:

Press 26-29, up, down, left, right to choose the status you want. Press 25 [OK] to confirm.

## DTV MODE(Optional Function)

Click TV icon in the main menu to enter the TV mode(can choose analog TV)

### TV Mode

- 1.Previous Channel
- 2.Next Channel
- 3.Volume
- 4.Automatic scan
- 5.Main Menu
- 6.Delete



## TV Mode

- 7.Favourite Chanel
- 8.OK
- 9.Drop out
- 10..come back
- 11.Set up
- 12.Status and time
- 13.Mute

### ◆TV system setup

Press **1** [TV setup] repeatedly to select the correct TV audio/video system. The selection sequence is as follows:

PAL\_L→PAL\_DK→PAL-BG→SECAML→SECAM\_BG→SECAM\_DK→NTSC\_M

### ◆Preset the TV

Press **2** [automatic scan] to scan and save the TV automatically. It can save up to 99 radio channels.

### ◆Volume control

Press **5**[+]and **6**[-] button to control the volume to increase and decrease. The volume is Split into 30 grades. If you turn off the unit [or close the ACC lock] when the volume is set below 10, the unit will come to the previous volume when you restart the device; if the volume is set above 10, the unit will restore to default 10 after you restart the unit.

### ◆Channel selection:

Press **4** and **3** buttons to select the previous channel and next channel respectively◆**Catalog**

Press **10** [catalog] to control digital TV catalog.

### ◆Exit

Press **11** [exit] to exit digital TV interface.

### ◆Scan radio

Press **12** [scan] to scan digital TV channels.

## BLUETOOTH MODE(Optional)

### Bluetooth

Please note the several following points before reading the Bluetooth operating instructions:

- ◆To connect the mobile phone Bluetooth, enter "Bluetooth" panel and press button to match.
- ◆After the successful match, the Bluetooth picture will turn to "Bluetooth icon".
- ◆Default matching password is 0000.

Phone dial number



- |                      |                           |
|----------------------|---------------------------|
| 1. Phone dial number | 6.Refuse /hang off calls  |
| 2. Phone book        | 7.Number display          |
| 3. Music display     | 8.MUTE                    |
| 4. Bluetooth set     | 9.Status and time display |
| 5.Dial/receive calls |                           |

### Phone Book



- |                                       |            |
|---------------------------------------|------------|
| 1. Phone book                         | 6.Next     |
| 2. Dialed calls                       | 7.Previous |
| 3. Received calls                     |            |
| 4. Missed calls                       |            |
| 5. Bluetooth / mobile phone switching |            |



## BLUETOOTH MODE(Optional)

### Bluetooth Music

◆The Bluetooth of this DVD supports A2DP, stereo Bluetooth music play protocol and automatic control. If the matched mobile phone supports the functions, you just need to **press 1** in the standby mode under the A2DP communication protocol, then, the device will control the mobile phone automatically to play its music. You can **press 1** to pause when play the music. The device returns to normal when you press it again. **Press 2** to stop playing and **1** to start to play again. **Press 3** to select the next program and **4** to select the previous program.

### Bluetooth setup

◆Press **1 [reset]** to see the save data of Bluetooth.Press**2 [cut]** to cut the connecting Bluetooth. Press**3 [connection]** to connect Bluetooth.  
◆Press **4** to increase/decrease the volume of Bluetooth,

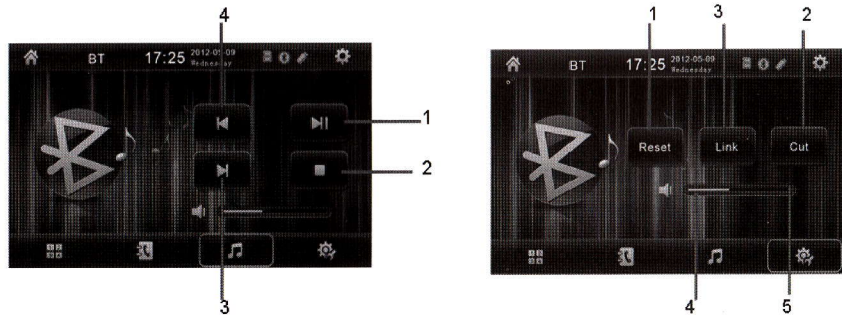

## IPOD OPERATING MODE

### IPOD operating mode(optional)

1. Next
2. Previous
3. Confirm
4. Volume + /-
5. Confirm
6. Random Button
7. Repeat
8. Turn off
9. Next video
10. Play/pause
11. Previous video
12. General setup menu
13. Status and time
14. Return to main menu



### ◆Volume control

Press 1 button to control the volume to increase and decrease. The volume is Split into 30 grades. If you turn off the unit [or close the ACC lock] when the volume is set below 10, the unit will come to the previous volume when you restart the device; if the volume is set above 10, the unit will restore to default 10 after you restart the unit.

### ◆Random

Press 2[random] to play audio and video in IPOD randomly.

### ◆Turn off

Press 3 [turn off] to close IPOD connecting status, IPOD will charge power immediately.

### ◆Repeat

Press 4 [repeat] to replay current program or cyclical replay all programs.

### ◆Menu play

Press 12 [menu] to enter menu play mode.

### ◆Program selection setup:

Press 9 or 11 to select next or previous respectively. ◆In play status:

Press 10 to pause / play, press it again to recover normal play.

### ◆In play status:

Press 6 [video] to enter video play; press 7 to select previous video, press 8 to select next video.



## AUX MODE

1. Volume -
2. Volume +
3. Mute / vocal

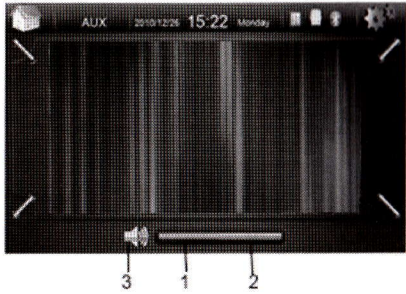

◆ Press 2 [+ ] and 1 [- ] button to control the volume to increase and decrease. The volume is Split into 30 grades. If you turn off the unit [or close the ACC lock] when the volume is set below 10, the unit will come to the previous volume when you restart the device; if the volume is set above 10, the unit will restore to default 10 after you restart the unit.

◆ Speaker status display:

Press 3 means mute, press it again to return to the vocal status.

## GPS OPERATION MODE (Optional Function)

### GPS Navigation (Operation)

Remark: Before Navigate, GPS Map card must be insert to this unit's GPS card Slot normally and set navigation path at the same time.

1) Navigation path settings:

Click the GPS Icon on the Main Interface enter into Navigation Console Interface, Click " Console" longly, pop up below interface.

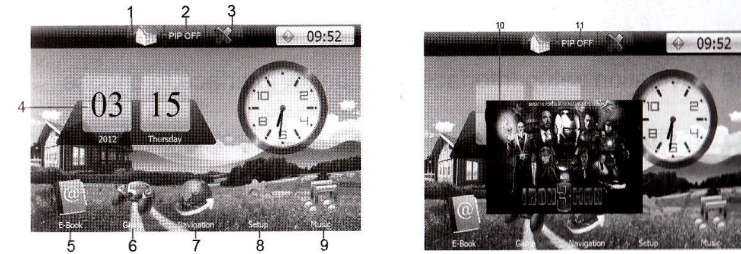

1. Back Main Interface Icon, It need waiting 3 seconds on another mode, then the Icon will work.
  2. Click "PIP OFF" go to Picture in Picture
  3. Close the PIP display
  4. Setting time Icon (We can see the time in GPS system)
  5. E-book Icon (Read some words)
  6. Games Icon (Playing Games)
  7. Navigation Icon, Click it go to Navigation Interface.
  8. Setup Icon, Click it go to set up Interface.
  9. Music Icon, Click it go to listen music.
  10. PIP Display size
  11. Close the PIP display.
- Click the "setup" Icon on the Console Interface, go to the below interface.





Click "Navigation set up" Icon on the setup interface, go to below interface.

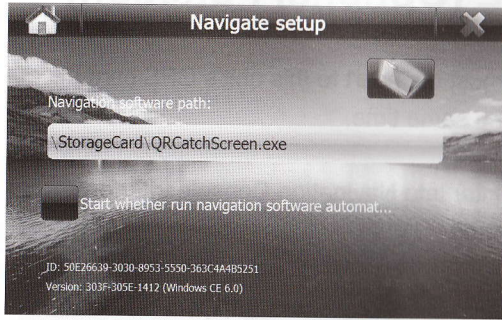

Click "folder" Icon on the Navigation setup Interface go to below interface, to choose navigation map software on this interface. Then click "OK" button, set up success.

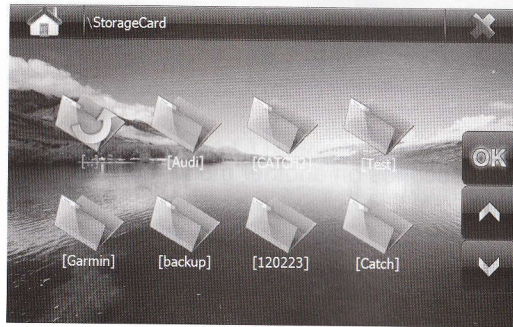

After Click "OK" Button, then the navigation software path set up successful, Click "Back" button back to console main menu.

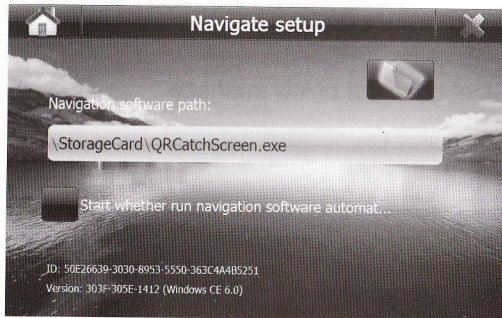

Click "GPS Monitor" on the set up interface, go to below interface, this interface display GPS signal and GPS signal strength.

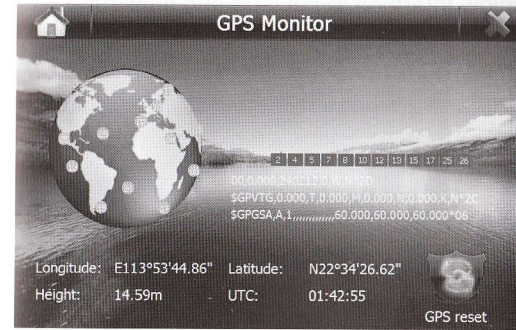

Click "Usual setup" on the Setup Interface, go to below interface "Key-Stroke Volume" Set "language" and "System Volume".



Click "Screen" on the Setup Interface, go to below interface, to adjust the screen's "Brightness color" and "Contrast".

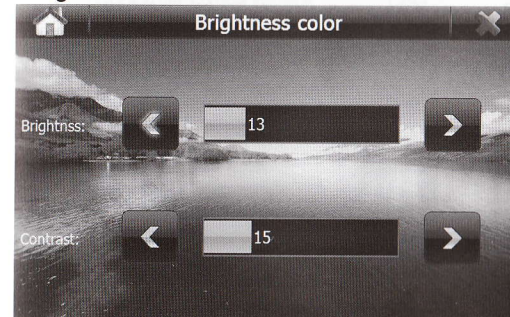



Click "Time" on the Setup interface,go to below Interface,to set time and time zone.



Click "System" on the Setup Interface,go to below Interface.It display GPS version number and RAM,Setting up the initial system and repair document.



Click "Skin" on the Setup Interface,go to below Interface, We will pull down the picture to change the background of GPS interface.

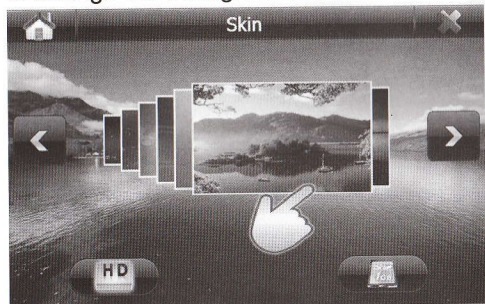

Click "Music" on the GPS Interface,go to below the interface.

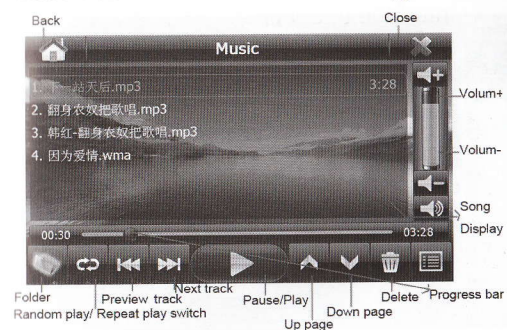

Click "Movie" on the GPS Interface,go to below the interface.

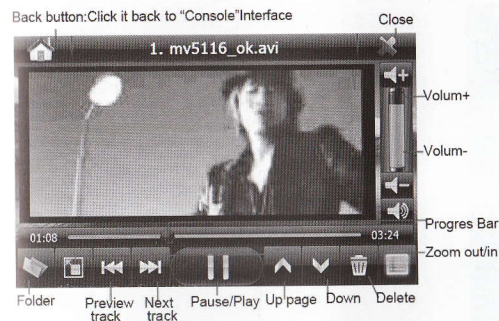

Click "E-Book" on the GPS Interface,go to below the interface.

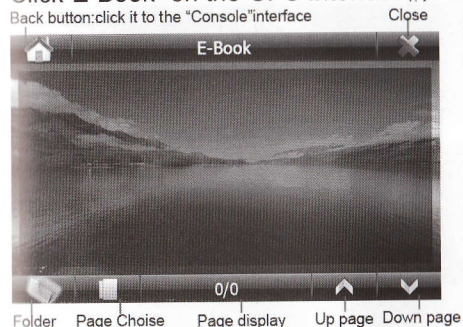



Click "Screen" the GPS interface, go to below interface.

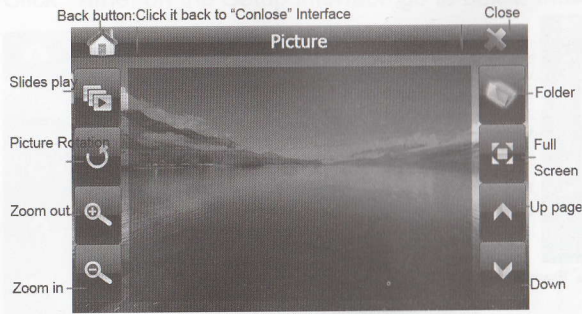

Click "Game" the GPS interface, go to below interface. Including 4 kinds of games

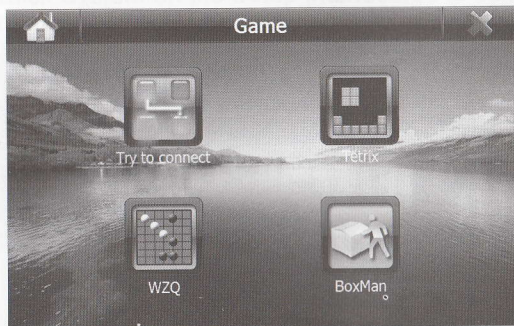

1. Try to connet game



1. Tetrix game

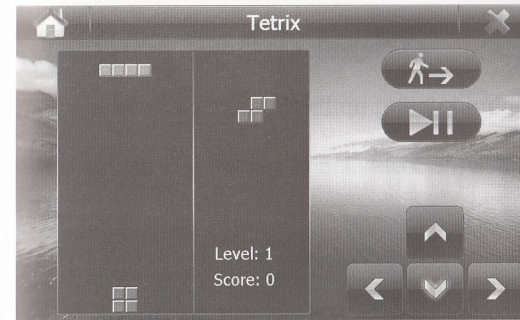

3. WZQ Game

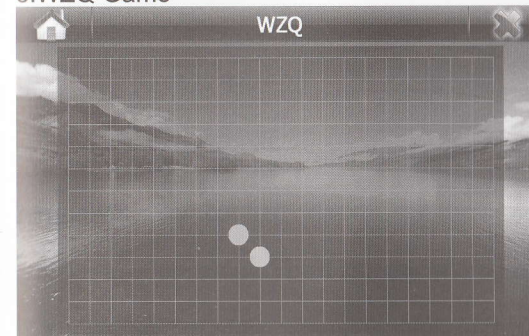

1. BoxMan Game

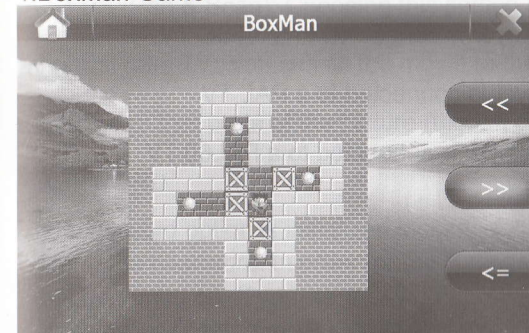



## System Setup Menu

You can press Setup key on the remote control to bring up the System Setup Menu when the unit is under the stop/playback mode.

### SETUP MENU Main Page

Press up/down direction button to select a item, then press ENTER.

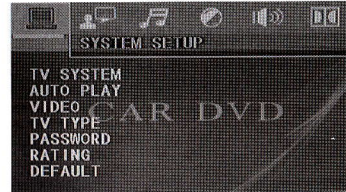

### System Setup

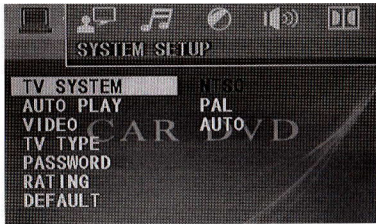

#### TV SYSTEM

According to the Color System of the TV, you can choose the TV System.

AUTO: Choose this settings if your DVD player is connected to a multi-system TV.

NTSC: Choose this settings if your DVD player is connected to a NTSC TV.

PAL: Choose this settings if your DVD player is connected to a PAL TV.

PAL60: Choose this settings if your DVD player is connected to a PAL60 TV.

The default setting is NTSC.

#### SCREEN SAVER

If the screen saver is on, when your DVD player is in Stop, Open, or No Disc state, or there is a frame frozen for more than 3 minutes, the screen saver will

## System Setup Menu

be displayed. This feature can protect the screen from damage.

ON: Choose this setting to activate the screen saver.

OFF: Choose this setting to cancel the screen saver

The default setting is ON.

#### TV TYPE

16: 9 (Wide Screen): Choose this setting if your DVD player is connected to a wide screen TV. If you choose this setting and you don't have a wide screen TV, the images on the screen may appear distorted due to vertical compression.

4: 3 LB (Letter Box): Choosing this setting if your DVD player is connected to a normal ratio TV. connector You'll see the movies in their original aspect ratio (height-to-width ratio). You'll see the entire frame of the movie, but it will take up a smaller portion of the screen vertically. The movie might appear with black bars at the top and bottom of the screen.

4 : 3 PS (Pan & Scan): Choosing this setting if your DVD player is connected to a normal ratio TV. You can fill the movie to the entire screen of your TV. This might mean that parts of the picture (the left and right edges) won't be seen.

#### PASSWORD

The password option is initialized locked, and you cannot set the ratings limit or change the password. In order for the Ratings feature work, the password mode must be turned on. If you want to set the ratings limit, you will need to enter the default password, which is 0000, then press Enter to confirm. To change the



## System Setup Menu

password, you will be prompted for the old password, then be prompted for a new. Enter a 4-digit number (this is your password).

Notes: Some time, the password is 6-digit number, the default is 000000.

### RATING

The Rating feature is a rating limit system, like movie ratings. It works with DVD discs that have been assigned a rating. This helps you control the types of DVDs that your family watches.

There are two rating options: NO ADULT and KID SAFE.

Select the VIEW ALL option to cancel the rating limit.

The default setting is VIEW ALL.

### DEFAULT

Choose this option to resume all the setup options to default settings.

### LANGUAGE SETUP



## System Setup Menu

### OSD LANGUAGE

press the Arrow buttons to choose the OSD language you prefer. Press Enter to confirm, and it will display OSD in that language; There are 8 optional OSD languages: Chinese, English, Japan, French, Spanish, Portuguese, German and Latin.

### AUDIO LANGUAGE

press the Arrow buttons to choose the audio language you prefer. Press Enter to confirm. If the disc you are playing has that language available, it will output audio in that language; There are 8 optional audio languages: Chinese, English, Japan, French, Spanish, Portuguese, German and Latin.

### SUBTITLE LANGUAGE

press the Arrow buttons to choose the subtitle language you prefer. Press Enter to confirm. If the disc you are playing has that language available, it will displays subtitles in that language; There are 8 optional audio languages: Chinese, English, Japan, French, Spanish, Portuguese, German, and Off.

### MENU LANGUAGE

press the Arrow buttons to choose the menu language you prefer. Press Enter to confirm. If the disc you are playing has that language available, it will displays

## System Setup Menu

menu in that language; There are 8 optional menu languages: Chinese, English, Japan, French, Spanish, Portuguese, German, and Off.

### AUDIO Setup

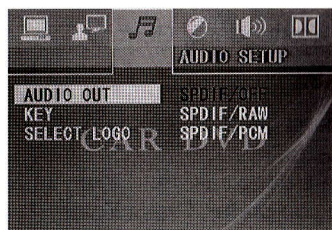

#### KEY

Use the Up and Down arrow button to move the scroll and adjust the key.

### VIDEO SETUP



#### BRIGHTNESS

Use the Up and Down arrow button to move the scroll and adjust the brightness.

#### CONTRAST

Use the Up and Down arrow button to move the scroll and adjust the contrast.

## System Setup Menu

### HUE

Use the Up and Down arrow button to move the scroll and adjust the hue.

### SATURATION

Use the Up and Down arrow button to move the scroll and adjust saturation.

### DIGITAL SETUP

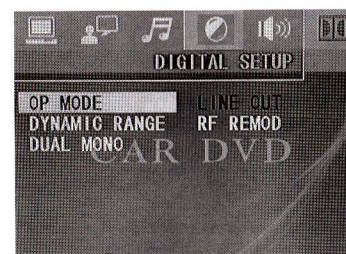

#### DYNAMIC RANGE:

When "LINE OUT" is selected, choose this setting to adjust the line out ratio and get different effect. If adjusting to FULL, the audio signal peak value will be the minimum; while adjusting to OFF, maximum. DUAL MONO

Choose this option to setup the L and R mono output mode; There are four modes in this option: STEREO, MONO L, MONO R, and MIX MONO; It is mainly used in karaoke mode.



# REMOTE OPERATION

## Remote operation

### Remote Control

1. Power supply
2. Play/Pause
3. Enter/Eject
4. Direction keys
5. Band/System switching button
6. Enter
7. Volume +/-
8. Select the channel/program/Fast backward/fast forward
9. Programming/Stereo
10. Playing time display
11. GPS screen switching
12. Repeat/Automatically save the channel
13. Random play/Local & remote control
14. Number keys
15. Audio settings
16. PBC settings
17. Mute
18. Desired program
19. Mode switching
20. Stop/Return
21. Angle selection
22. Title/Language settings
23. Main menu setup
24. Title/Catalog settings
25. Zoom in/Zoom out
26. GPS shortcut/mode
27. TFT screen up-sliding key
28. TFT screen down-sliding key
29. Compensation of equal-loudness

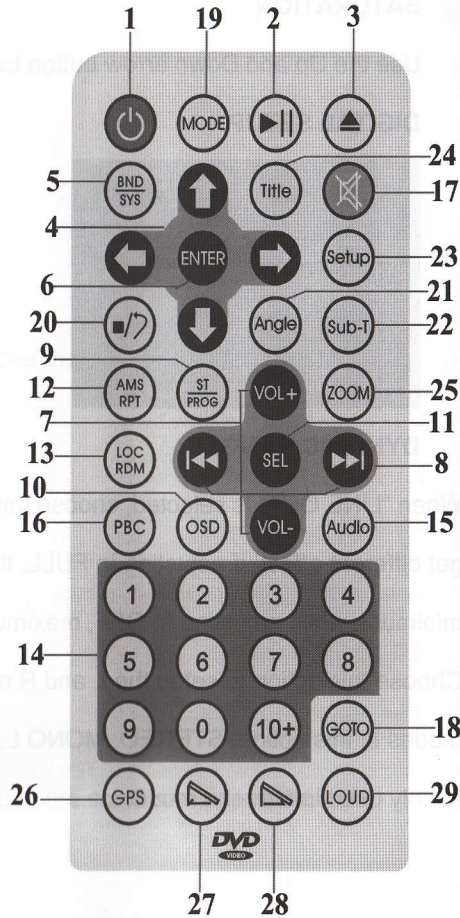

# SPECIFICATION

General	
Power supply	4.4VDC
Load	4Ω
Max. Power output	50W*4
Tone control	+/-8db(Bass:100Hz,Treble:10KHz)
Dimensions	About192*178*100mm(D*W*H)
Installation dimension	About169*182*103mm(D*W*H)
Weight	About 2.65kg
Applicable disc	MPEG4.DVD,SUPER,VCD.MP3,CD,CD-R, CD-RW, PICTURE-CD
Video system	AUTO, NTSC, PAL
Installation angle	0-+/-30
<b>Video</b>	
Video system	16:9 Mail MODE/16:9FULL SCREEN
Video output	1.0Vp-p.75ohms
Resolution	500
Max. Output	600 Ω (2.0Vrms)
Frequency scope	20Hz-20 KHz

# SIMPLE TROUBLE SHOOTING GUIDE

Problems	Reasons and settlement
No power	Check whether the fuse of power supply is broken. Change for another one with a proper capacity if necessary.
LCD display mess-up and the key does not work	Press Reset Key
Cannot receive the radio channel	Check whether the antenna is connected or whether it is connected well. Connect the antenna well.
Bad effect on receiving the radio	The length of the antenna may not enough. Check whether the antenna is spread out or broken. Change for a new one if it is broken. The broadcasting signal is too weak, change for another one with a strong signal. The antenna is not connected to the ground properly. Make sure whether the antenna is connected well to the ground.
Cannot put the disc into the DVD	There is a disc inside the DVD. Withdraw the disc to solve it.
Stereo indicator flashes	Perfect the tuning frequency The broadcasting signal is too weak. Please set it in the MONO mode
Noise	The disc is broken or dirty. Change for a good disc.
No picture	The video cable between the DVD and TV is not connected well.
The picture shake	The system color setting is not correct. Set the color system to "PAT" or "NTSC" according to your TV.
Bluetooth cannot work	Check whether the Bluetooth mobile phone matches the DVD and whether it is correctly connected to the DVD. Match and connect it again according to the instruction of the mobile phone.
Echo is too loud in Bluetooth talk	The volume is too loud. Turn the DVD down to a proper volume.