

**SONY**

3-755-612-21(1)

# *Digital Audio Tape Deck*

---

Operating Instructions



© 1992 by Sony Corporation

# WARNING

## Operating Instructions

Before operating the unit, please read this manual thoroughly and retain it for future reference.

### Owner's Record

The model number is located on the rear exterior and serial number is on the rear. Record the serial number in the space provided below. Refer to these numbers whenever you call upon your Sony dealer regarding this product.

Model No. DTC-59ES

Serial No. \_\_\_\_\_

## WARNING

**To prevent fire or shock hazard, do not expose the unit to rain or moisture.**

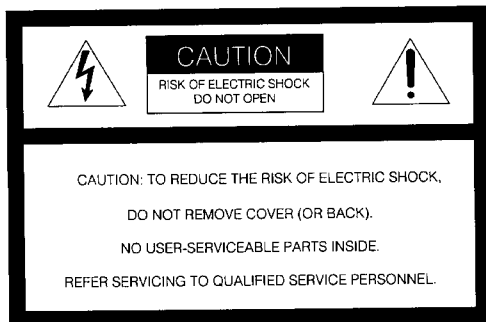

This symbol is intended to alert the user to the presence of uninsulated "dangerous voltage" within the product's enclosure that may be of sufficient magnitude to constitute a risk of electric shock to persons.



This symbol is intended to alert the user to the presence of important operating and maintenance (servicing) instructions in the literature accompanying the appliance.

\* The graphical symbol are on the rear enclosure.

### INFORMATION (For the customers in the U.S.A.)

This equipment generates and uses radio frequency energy and if not installed and used properly, that is, in strict accordance with the manufacturer's instructions, may cause interference to radio and televisions reception. It has been type tested and found to comply with the limits for a Class B computing device in accordance with the specifications in Subpart J of Part 15 of FCC Rules, which are designed to provide reasonable protection against such interference in a residential installation. However, there is no guarantee that interference will not occur in a particular installation. If this equipment does cause interference to radio or television reception, which can be determined by turning the equipment off and on, the user is encouraged to try to correct the interference by one or more of the following measures:

Reorient the receiving antenna

Relocate the equipment with respect to the receiver

Move the equipment away from the receiver

Plug the equipment into a different outlet so that equipment and receiver are on different outlet so that equipment and receiver are on different branch circuits.

If necessary, the user should consult the dealer or an experienced radio/television technician for additional suggestions. The user may find the following booklet prepared by the Federal Communications Commission helpful:

"How to identify and Resolve Radio-TV Interference Problems". This booklet is available from the U.S. Government Printing Office, Washington, DC 20402, Stock No. 004-000-00345-4.

"You are cautioned that any changes or modifications not expressly approved in this manual could void your authority to operate this equipment"

### For the customers in Canada

This apparatus complies with the Class B limits for radio noise emissions set out in Radio Interference Regulations.

#### CAUTION:

TO PREVENT ELECTRIC SHOCK, DO NOT USE THIS POLARIZED AC PLUG WITH AN EXTENSION CORD, RECEPTACLE OR OTHER OUTLET UNLESS THE BLADES CAN BE FULLY INSERTED TO PREVENT BLADE EXPOSURE.

# Table of Contents

## Before using the DAT deck

|  |    |
|--|----|
| Warning .....                              | 2  |
| Digital audio tape .....                   | 3  |
| Precautions .....                          | 4  |
| Features .....                             | 5  |
| Location and function of controls .....    | 6  |
| Front panel/remote commander .....         | 6  |
| Remote commander operation .....           | 9  |
| Installing batteries .....                 | 9  |
| Display window .....                       | 10 |
| Connections .....                          | 13 |
| Rear panel jacks .....                     | 13 |
| Connecting cords .....                     | 14 |
| Connecting the remote control system ..... | 14 |
| Connection examples .....                  | 15 |
| Clock setting .....                        | 17 |
| Setting the date and time .....            | 17 |
| Cassette loading .....                     | 19 |

## Recording

|  |    |
|--|----|
| Before recording .....                               | 20 |
| Blank section and sound muted portion .....          | 20 |
| Absolute time codes .....                            | 20 |
| Recording .....                                      | 21 |
| To store the recording date and time .....           | 22 |
| To check the recording date and time .....           | 22 |
| Creating a sound muted portion (Record Muting) ..... | 24 |
| End search .....                                     | 24 |
| Fade-in/fade-out recording .....                     | 25 |
| CD synchronized recording .....                      | 25 |

## Writing sub codes

|  |    |
|--|----|
| Sub codes .....  | 26 |
| Start ID .....   | 28 |
| Writing automatically during recording .....                   | 28 |
| Writing manually during recording .....                        | 28 |
| Writing manually during playback<br>(Rehearsal function) ..... | 29 |
| Adjusting the position .....                                   | 29 |
| Erasing .....  | 29 |

|  |    |
|--|----|
| Program numbers .....                              | 30 |
| Writing automatically during recording .....       | 30 |
| Renumbering .....                                  | 31 |
| Erasing .....                                      | 31 |
| Skip ID .....                                      | 32 |
| Writing during recording .....                     | 32 |
| Writing during playback (Rehearsal Function) ..... | 32 |
| Erasing .....                                      | 32 |
| End ID .....                                       | 33 |
| Writing during recording .....                     | 33 |
| Writing during playback (Rehearsal Function) ..... | 33 |
| Erasing .....                                      | 34 |

## Playback

|  |    |
|--|----|
| Playback .....                                       | 34 |
| Display window .....                                 | 35 |
| Various playback operations .....                    | 36 |
| Fade-in/fade-out play .....                          | 36 |
| Repeat play .....                                    | 36 |
| Automatic music sensor operation .....               | 37 |
| Music scan .....                                     | 37 |
| Designating the desired selection .....              | 38 |
| Skip play .....                                      | 38 |
| Auto play: restarting playback after rewinding ..... | 38 |
| Random music sensor (RMS) operation .....            | 39 |
| Timer activated operation .....                      | 40 |
| Timer activated recording .....                      | 40 |
| Timer activated playback .....                       | 40 |

## Additional Information

|  |    |
|--|----|
| Maintenance .....                                | 41 |
| Cleaning the cabinet .....                       | 41 |
| Cleaning the head .....                          | 41 |
| Guide to the serial copy management system ..... | 42 |
| Troubleshooting .....                            | 44 |
| Specifications .....                             | 47 |

### Digital Audio Tape

DAT (Digital Audio Tape) is a new recording system which digitalizes the audio signal and records it on a DAT cassette tape.

DAT records the audio signal by converting the analog sound into a digital signal. This converting system is called the PCM (Pulse Code Modulation), and its accurate processing of the audio signal allows recording/playback with lower wow and flutter, wider dynamic range, lower distortion rate, and superb signal-to-noise ratio.

In addition, various control codes called sub codes can be written on the DAT cassette separately from the audio signal. They are written for a variety of convenient playback/tape editing operations, and except for the absolute time, can be rewritten after audio signal recording has been completed.

# Precautions

## Safety

- Operate the unit only on 120 V AC, 60 Hz.
- One blade of the plug is wider than the other for the purpose of safety and will fit into the power outlet only one way. If you are unable to insert the plug fully into the outlet, contact your dealer.
- This unit is not disconnected from the AC power source (mains) as long as it is connected to the wall outlet even if the unit itself has been turned off.
- Should any solid object or liquid fall into the cabinet, unplug the unit and have it checked by qualified personnel before operating it any further.
- Unplug the unit from the wall outlet if it is not to be used for an extended period of time. To disconnect the cord, pull it out by grasping the plug. Never pull the cord itself.

## Operation

Before making program source connections, be sure to unplug the unit.

## Installation

Do not install the unit in a location near heat sources such as radiators or air ducts, or in a place subject to direct sunlight, excessive dust, mechanical vibration or shock.

## Moisture Condensation

If the unit is brought directly from a cold to a warm location, moisture may condense inside the unit. In this condition, the tape may adhere to the head drum and be damaged, or the unit may not operate correctly. Always remove the cassette when the unit will not be used.

## If moisture is present...

- Function controls will not operate.
- All operations will stop.

## When the CAUTION indicator lights and the unit will not operate

Leave the unit turned on for about an hour.

## Detaching the Side Panels

After removing the screws, secure the cabinet with the supplied lock screws (M4 x 6). Do not use the longer screws.

For safety, before doing this, be sure to disconnect the AC power cord from the AC outlet.

## NOTE

When closing the cassette compartment, do not push the cassette lid forcibly by hand, but perform with the **▲OPEN/CLOSE** button.

## For the customers in the U.S.A.

For detailed safety precautions, see the "IMPORTANT SAFEGUARDS" leaflet.

If you have any question or problem concerning your unit, please consult your nearest Sony dealer.

# Features

## **Serial copy management system**

This unit utilizes the serial copy management system that permits digital-to-digital recording for one generation. You can record CD sound or other digital formats through a digital-to-digital connection. (See page 42.)

## **Date Function automatically memories the recording date and time**

The year, month, day, day of the week, hour, minute and second are automatically memorized in the subcode area during recording, so that during playback you can display this data to check when the tape was recorded. This function is especially convenient when recording live performances, etc.

## **Three sampling frequencies**

Recording/playback can be done with three sampling frequencies (48 kHz, 44.1 kHz and 32 kHz).

48 kHz: For analog and digital input signals in a standard mode.

44.1 kHz: For compact disc and pre-recorded DAT tape.

32 kHz: For analog input signals in a long-play mode.

## **Long play mode**

This unit can operate in a long-play mode. Analog input signals can be recorded or playback for up to four consecutive hours when the DT-120 DAT cassette tape is used. The sampling frequency will be 32 kHz in the long-play mode.

## **Visible cassette loading**

You can view the tape operation through the lid of the cassette compartment. Due to a revolutionary new transport mechanism, cassette loading time has been significantly reduced.

## **Excellent sound quality**

### **1-bit A/D converter**

For the A/D converter section which converts analog input signals to digital signals, the unit employs a 1-bit A/D converter which theoretically generates no zero-cross distortion for a clear, elegant sound quality.

### **Pulse D/A converter**

Superior playback performance is achieved with a 1-bit D/A converter.

## **Rich variety of subcode information**

This unit can record subcode information such as Start IDs, program numbers, Skip IDs, and absolute time data, enabling you to quickly locate tunes and display the playback time in the same manner as when playing compact discs.

## **Digital fade-in/fade-out**

Professional sounding fade-in/fade-out of either digital or analog signals can be accomplished by use of the FADER button.

## **Post edit recording of sub codes**

You can record or rewrite the following sub codes after the audio signal recording has been completed.

Start ID: Signifies the beginning of a selection.

Program number: Gives a number to the selection.

Skip ID: Signifies the beginning of a portion to be skipped.

End ID: Signifies the end position of recording/playback.

Since sub codes are written on the tape separately from audio signals, the audio signals are not affected.

# Location and Function of Controls

## Front Panel/Remote Commander

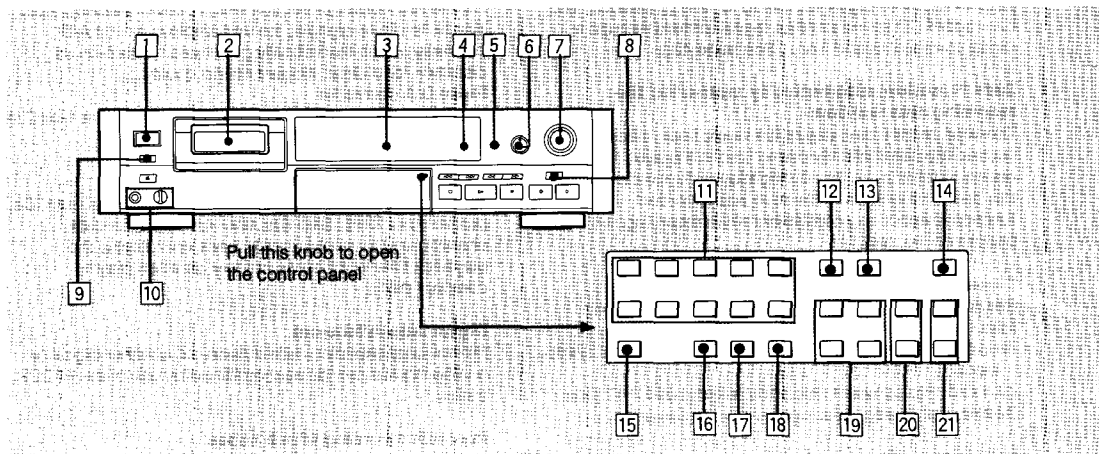

- 1 POWER switch**  
Turns the power on and off.
- 2 Cassette compartment**  
Insert a cassette with the window side up and the safety tab facing you.
- 3 Display window**
- 4 Remote sensor**  
Receives the signal from the remote commander.
- 5 MODE button**  
Selects the display mode among the absolute time, elapsed time of the current selection, remaining time to the end of whole tape and linear counter (tape running time). Each time you press the button, the display changes sequentially.
- 6 INPUT SELECT selector**  
Set according to the signal to be recorded.  
**ANALOG:** For recording from the equipment connected to the LINE IN jacks.  
**OPTICAL:** For recording from the equipment connected to the DIGITAL IN (OPTICAL) jack.  
**COAXIAL:** For recording from the equipment connected to the DIGITAL IN (COAXIAL) jack.
- 7 REC LEVEL (recording level) controls**  
Adjust the recording levels and balance for the analog input signals.  
*The outer knob controls the L (left) channel level and the inner knob the R (right) channel level. The knobs can be adjusted together. To adjust each channel independently, turn the knob while holding the other knob.*  
When recording digital signals, it is not necessary to adjust the recording levels.
- 8 REC MODE selector**  
Normally set to the STANDARD position.  
When this selector is set to the LONG position, you can record analog input signals or digital signals with 32 kHz in the long-play mode.
- 9 TIMER switch**  
Normally set to the OFF position. When recording or playing back at the desired time using a commercially available audio timer, set to the REC position or the PLAY position respectively.
- 10 PHONES-LEVEL jack and control**  
Insert the headphones plug to this jack and turn the control to adjust the headphones volume level.
- 11 Numeric buttons (0-9)**  
Designate the desired program number to be played back before starting playback. Designate the desired number in the record-pause mode, the program number is written consecutively from the designated number.

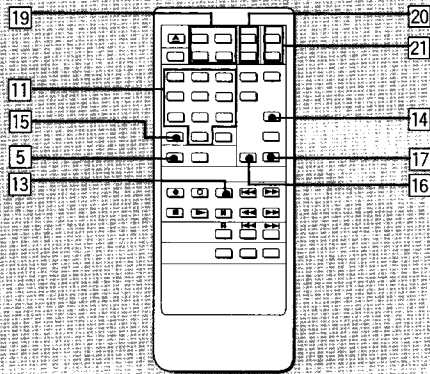

**12 MUSIC SCAN button**

Press to listen to the beginning of each selection successively.

**13 FADER button**

Press to fade in or fade out during recording or playback.

**14 MARGIN RESET button**

Press to reset the margin of peak level.

**15 CLEAR button**

Press to cancel the program number which has been mistakenly entered.

**16 RECORDED button**

Press to display the recording day of the tape being played.

**17 PRESENT button**

Press to display the current time. Each time the RECORDED or PRESENT button is pressed, day, month and year display, the day of the week display or hour, minute and second display is switched sequentially.

**18 CLOCK SET button**

Press to adjust the time of the clock built in this unit. In this mode, the 0 button and the 9 button function as the + and - buttons respectively.

**19 START ID buttons**

**AUTO:** Press to turn on and off the AUTO indicator.

When the AUTO indicator is lit, the start ID will automatically be written during recording. When the AUTO indicator is not lit, press the START ID WRITE button at the point where you want to write a start ID.

**WRITE:** Press to write the start ID at the desired point during recording or playback.

**ERASE:** Press to erase a start ID. When a start ID and a program number are written on the tape, both codes are simultaneously erased by pressing this button.

**RENUMBER:** Press to renumber all programs on the tape. When only the start IDs are written, pressing this button will insert the proper program numbers beginning with "1". The tape will rewind and start from the beginning to accomplish this function.

**20 SKIP ID buttons**

**WRITE:** Press at the beginning of the portion you may wish to skip later. A skip ID will be written from the point where you pressed this button.

**ERASE:** Press to erase the nearest skip ID which is before the current position.

**21 END ID buttons**

**WRITE:** Press to write the ID signifying the end of playback or recording.

**ERASE:** Press to erase the end ID.

# Location and Function of Controls

## Front Panel/Remote Commander

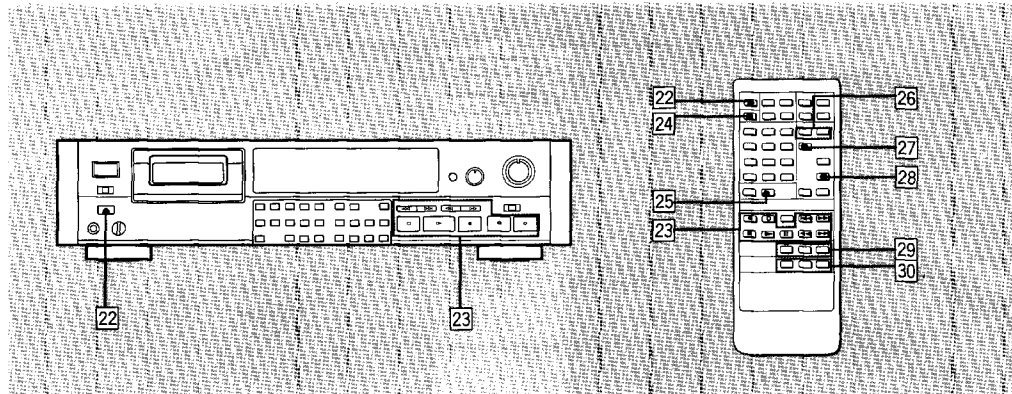

- 22 ▲OPEN/CLOSE button**  
Press to open or close the cassette compartment.
- 23 Tape operating buttons**  
■ **(stop):** Press to stop recording or playback.  
▶ **(play):** Press to play back the tape.  
⏸ **II PAUSE (pause):** Press to stop for a moment during recording or playback. To restart recording or playback from the stop mode, press this button again or press the ▶ button.  
If the unit is left in the pause mode for about 10 minutes, it will automatically be released and the deck will enter the stop mode. To restart recording or playback from the stop mode, press the ●REC or ▶ button respectively.  
⏸ **OREC MUTE (record muting):** Inserts a sound-muted portion (space).  
● **REC (recording):** Press to enter the record-pause mode. After pressing this button, press the ⏸ pause or ▶ button.  
◀◀/▶▶ **(AMS):** Press to locate the beginning of the selection during the playback.  
◀◀/▶▶ **(rewind/review, fast-forward/cue):** In the stop mode, press to *rewind/fast-forward* the tape. During playback, press to *rewind or fast-forward* the tape while listening to the sound.
- 24 DISPLAY MODE button**  
Changes the display mode. (Refer to page 10.)
- 25 RESET**  
Resets the linear counter to "0M 00S".
- 26 RMS play buttons**  
**ENTER:** To program the selections in a desired order, press this button after pressing the numeric buttons.  
**CHECK:** Press to check the programmed contents.
- 27 REPEAT 1/ALL button**  
Press to play a desired portion repeatedly. Each time you press the button, the indicator changes as follows: REPEAT 1 → REPEAT ALL → off
- 28 SKIP PLAY button**  
Press to activate the skip ID code function. The portion of the tape previously marked will be skipped.
- 29 CD operation buttons**  
Operative only for the Sony CD player equipped with a Remote Commander.  
⏸ **(pause):** Press this button twice to start playback. Press this button once in the playback mode, the deck enters the pause mode.  
◀◀/▶▶ **(AMS):** Press to locate the desired selection on the Compact Disc during playback or in the stop mode.
- 30 CD SYNCHRO (CD synchronized recording) buttons**  
(The playback of the Sony CD player equipped with a Remote Commander and the recording of the DAT deck can be performed simultaneously.)  
**STANDBY:** Press to set the unit in the record-standby mode.  
**START:** Press to start recording of the DAT deck and then playback of the CD player.  
**STOP:** Press to stop the DAT deck recording and the CD player playback.



## Remote Commander Operation

Each button on the remote commander functions in the same way as those having the same name on the front panel.

However, the following operations cannot be performed using the remote commander. Use the front panel controls instead.

- Turning the power on and off
- Selecting digital(optical/coaxial)/analog input source
- Setting the clock
- Adjusting the recording level and balance
- Adjusting the headphones level
- Setting the timer recording/playback
- Selecting the record mode (standard or long)

The following operations can be performed only with the remote commander.

- To activate CD synchronized recording using a Sony CD player and controlling the CD player
- To locate the desired selection on the Compact Disc or to set the CD player in the pause mode (possible only when a Sony CD player is used.)
- Repeat play
- Skip play
- RMS\* play
- To reset the linear counter to "0 M 00S"

## Installing Batteries

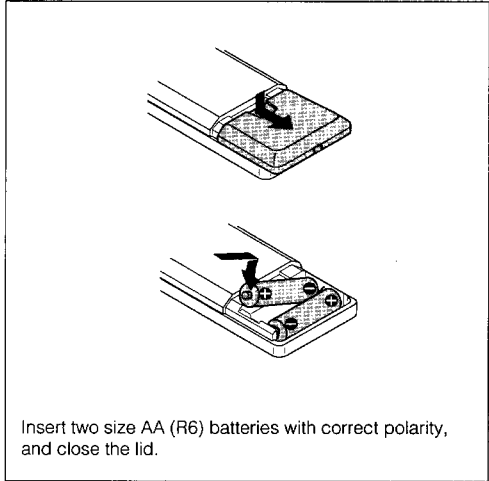

### Notes on remote control

- Do not expose the remote sensor on the deck to strong light such as direct sunlight, lighting apparatus, etc.
- Do not place any obstructions between the Remote Commander and the remote sensor, or else operations will not be performed correctly.
- The controllable range is limited. Point the Remote Commander directly at the remote sensor on the deck.
- When remote control operation distance becomes shorter, the batteries are weak. Replace both batteries with new ones.

### To avoid battery leakage

When the commander will not be used for a long period of time, remove the batteries to avoid damage caused by battery leakage and corrosion.

### Battery life

About half a year of normal operation can be expected when using the Sony SUM-3 (NS) batteries.

# Location and Function of Controls

## Display Window

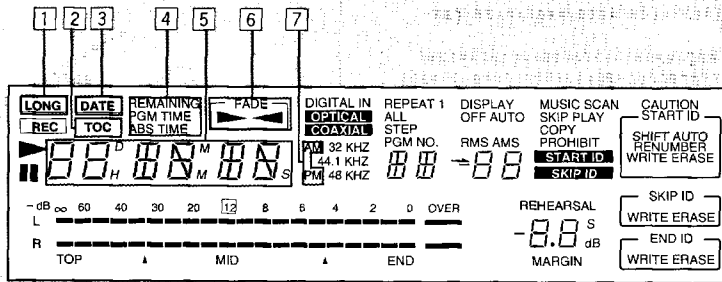

### To turn off the display window

When the power is turned on, the display window also is turned on. During recording or playback, all display or some parts of the display can be turned off as follows:

#### When operating with the front panel controls

While pressing the MODE button, press the 0 button.

#### When operating with the remote commander

Press the DISPLAY MODE button.

Each time you press the above buttons, the indicators change as follows:

Normal indicators ←

↓  
Peak level meters and margin indicators go off.  
(The DISPLAY OFF indicator lights.)

↓  
All the indicators go off during recording or playback\*.  
(The DISPLAY OFF AUTO indicator lights momentarily just before the indicators go off.)

\* When pressing the MODE or DISPLAY MODE button except during recording or playback, the DISPLAY OFF AUTO indicator lights. In this case, all the indicators go off immediately after recording or playback starts.

### To change the brightness of the display window

While pressing the MODE button on the front panel or the COUNTER MODE button on the remote commander, press one of the numeric buttons 1, 2 and 3. The greater number pressed, the darker the display window becomes.

### 1 LONG play mode indicator

Lights when recording or playback is being performed in the long play mode.

### 2 TOC (Table Of Contents) indicator

When a pre-recorded DAT cassette is played back, this indicator will light.

### 3 DATE indicator

Lights when the RECORDED button is pressed to display the recording day of the tape being played. Flashes when the PRESENT button is pressed to display the current time.

### 4 REMAINING (remaining time): Lights when the counter shows the remaining time of the tape.

**PGM TIME (program time):** Lights when the counter shows the elapsed time of the current selection.

**ABS TIME (absolute time) indicator:** Lights when the counter shows the elapsed time from the beginning of the tape.

### 5 Time indicator

Indicates the tape running time, absolute time, elapsed time of the current selection, remaining time or recording day. Each time the MODE button is pressed, the display is changed.

### 6 Fade in/out indicator

: Flashes when recording or playback fades in.

: Flashes when recording or playback fades out.

### 7 AM/PM indicators

Show AM or PM of the time.

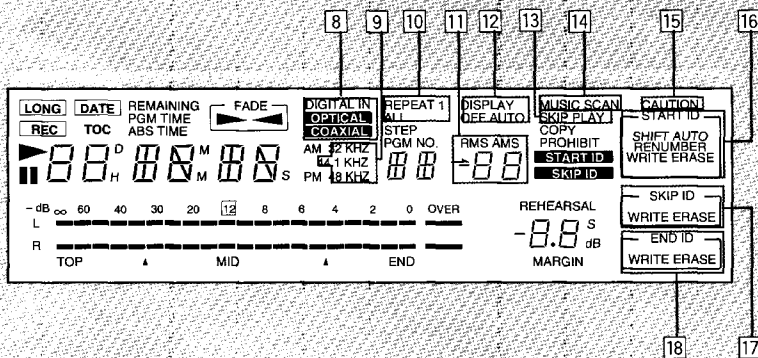

**8 INPUT selector indicators**

The DIGITAL IN OPTICAL or COAXIAL indicator lights according to the position of the INPUT selector. No indicator lights when the INPUT selector is set to the ANALOG position.

**9 SAMPLING FREQ. (Sampling frequency) indicator**

**48 kHz:** For recording/playback of analog input signals (standard mode).  
**44.1 kHz:** For recording/playback of CD or a pre-recorded DAT cassette.  
**32 kHz:** For recording/playback of analog input signals (long-play mode).

**10 REPEAT indicators**

**REPEAT 1:** Lights when a desired selection is played back repeatedly.  
**REPEAT ALL:** Lights when all the selections are played back repeatedly.

**11 AMS (Automatic Music Sensor)/RMS (Random Music Sensor) indicators**

Show the number of selections to be skipped ahead or behind in the AMS operation. When designating a selection directly by the numeric button and the ► button, the display shows the program number of the target selection while the selection is being searched for. When programming the desired selections in the RMS operation (page 39), the display shows the program number of the selection to be programmed.

**12 DISPLAY OFF/AUTO indicators**

The DISPLAY OFF indicator lights when peak level meters and margin indicators are turned off. The DISPLAY OFF AUTO indicator lights momentarily before all the indicators are turned off.

**13 SKIP PLAY indicator**

When this indicator is lit during playback, the portion marked by the skip ID is skipped and playback continues from the next start ID.

**14 MUSIC SCAN indicator**

Lights after the MUSIC SCAN button is pressed to listen to the beginning of each selection successively.

**15 CAUTION indicator**

Lights when moisture condensation occurs. If this happens, the deck stops functioning automatically. (See page 4.)

**16 START ID mode indicators**

**AUTO:** Lights when the AUTO button is pressed to write the start ID automatically.  
**RENUMBER:** Lights when the RENUMBER button is pressed to renumber the program numbers.  
**WRITE:** Lights when writing the start ID manually.  
**ERASE:** Lights when erasing the start ID.  
**AUTO RENUMBER:** Lights when renumbering program numbers automatically.  
**SHIFT RENUMBER:** Lights when shifting the start ID and program number position.

**17 SKIP ID mode indicator**

**WRITE:** Lights when writing the skip ID.  
**ERASE:** Lights when erasing the skip ID.

**18 END ID mode indicator**

**WRITE:** Lights when writing the end ID.  
**ERASE:** Lights when erasing the end ID.

# Location and Function of Controls

## Display Window

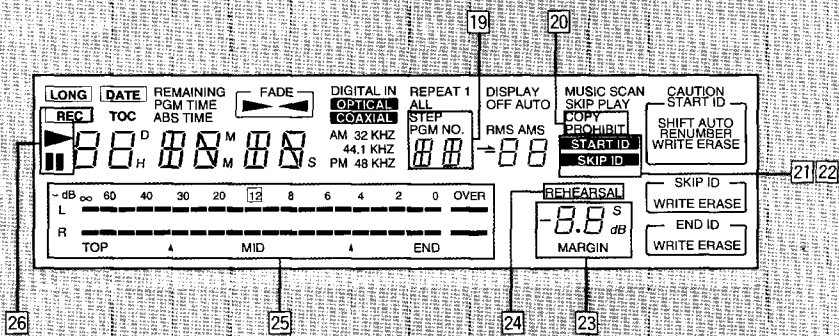

### 19 STEP/PGM NO. indicator

Shows the program number of the selection being played. When programming the desired selection with the RMS operation (page 39), the display shows the step number of the programmed selection.

### 20 COPY PROHIBIT indicator

Lights when recording the digital signal with the copy prohibit code. In this case, record with the LINE IN jacks.

### 21 START ID indicator

Flashes when writing (for 9 or 18 seconds) or erasing a start ID code, and lights when the start ID is detected during playback.

### 22 SKIP ID indicator

Lights when writing (for 1 or 2 seconds) or erasing a skip ID code or when the skip ID is detected during playback.

### 23 MARGIN indicator

Shows how much margin there is between the peak level of input audio signal and 0 dB.

### 24 REHEARSAL indicator

Lights while the rehearsal function is activated (page 29).

### 25 Peak level meters/Frequencies map

Indicate the signal levels during playback and recording. There are separate meters for each left and right channel. These meters have a peak hold function which indicates the peak level momentarily. When pressing the 4 button while keeping the MODE button pressed, the sampling frequencies with which the tape was recorded is displayed.

### 26 Tape operation indicators

**REC**: Lights during recording or in the record-pause mode.

**▶**: Lights during recording or playback. It also lights in the record-pause mode or in the play-pause mode.

**■**: Lights in the record-pause mode or in the play-pause mode.

# Connections

## Rear Panel Jacks

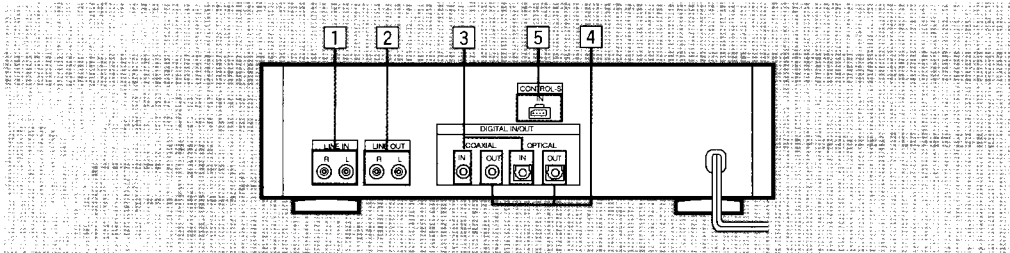

- 1 LINE IN (line input) jacks (phono jack)**  
Connect to the recording outputs of an amplifier. Signals supplied by the amplifier can be recorded using the sampling frequency of 48 kHz in the standard play mode or 32 kHz in the long play mode.
- 2 LINE OUT (line output) jacks (phono jack)**  
Connect to the DAT or tape inputs of an amplifier. The playback signal of this deck will be output.
- 3 COAXIAL/OPTICAL DIGITAL IN (digital input) jacks (coaxial phono jack/optical jack)**  
Connect to the digital outputs of an amplifier having a built-in D/A converter or other digital source, such as a CD player for digital-to-digital recording.
- 4 COAXIAL/OPTICAL DIGITAL OUT (digital output) jack (coaxial phono jack/optical jack)**  
Connect to the digital inputs of an amplifier having a built-in D/A converter or another DAT deck, for playback of a DAT cassette or digital-to-digital recording.
- 5 CONTROL-S IN jack**  
Connect to the CONTROL-S output of a Sony amplifier or receiver for remote control.

### Notes on connection

- Use the connecting cords specified in the illustrations.
- Turn off the power for all equipments before making connections.
- Be sure to insert the plugs firmly into the jacks. Loose connections may cause hum and noise. When unplugging, grasp the plug and not the cord.

### Notes on the optical cable

- Do not bend the cord. When the cord is not used, curl it with a diameter of more than 15 cm ( $5\frac{7}{8}$  inches).
- Do not use it under high temperatures.
- When the optical cable is not connected, cover the OPTICAL IN/OUT jacks with the supplied caps.

### Note on sound signals

When connecting an optical cable to the DIGITAL IN/ DIGITAL OUT jacks, sound signals (L/R) are transmitted together through the cable.



### Note on the CONTROL-S IN jack

To remote control this unit through a receiver or amplifier, connect the input of this unit to the CONTROL-S output of a Sony receiver or amplifier, with a CONTROL-S cable. When this connection is used, only remote control commands sent through the receiver or amplifier will be executed. The remote sensor of this unit will not function.

# Connections

## Connecting Cords

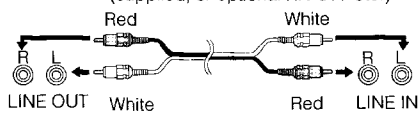
There are following three types of connecting jacks at the rear of the deck. Each type of jack requires a different type of connecting cord.

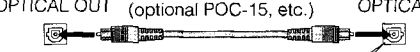
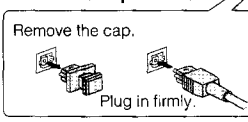
| Jack  | Required cord  |
|---|--|
| <b>LINE IN/OUT (analog input/output) jacks</b>                          | <p>Audio signal connecting cord<br/>(supplied, or optional RK-C77 etc.)</p>    |
| <b>COAXIAL IN/OUT (digital input/output) jacks</b>                      | <p>Coaxial digital connecting cord<br/>(optional VMC-1ES, etc.)</p>    |
| <b>OPTICAL IN/OUT (optical transmission digital input/output) jacks</b> | <p>Optical cable<br/>(optional POC-15, etc.)</p>  <p><b>How to connect the optical cable</b></p>  |

## Connecting the Remote Control System

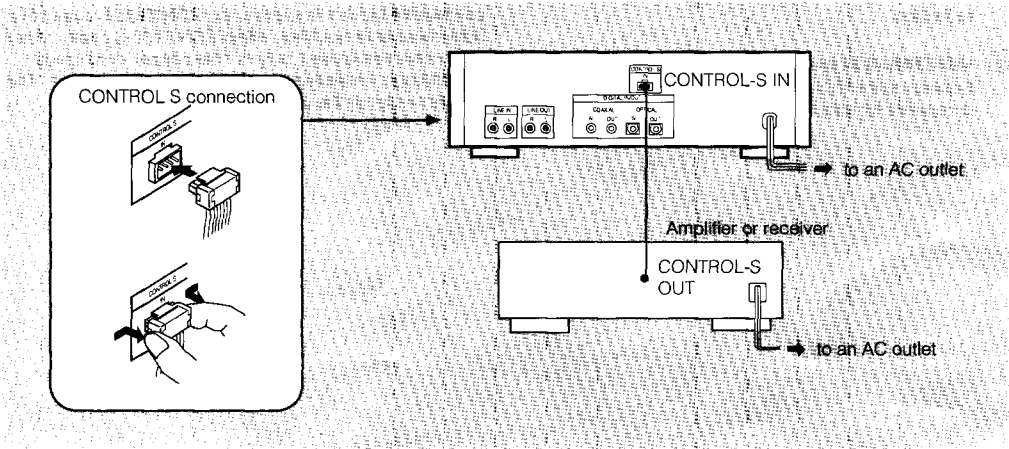

## Connection Examples

### If your amplifier is not equipped with digital signal jacks

- : Analog signal
- : Digital signal  
(coaxial cable or optical cable)
- ↳ : Signal flow

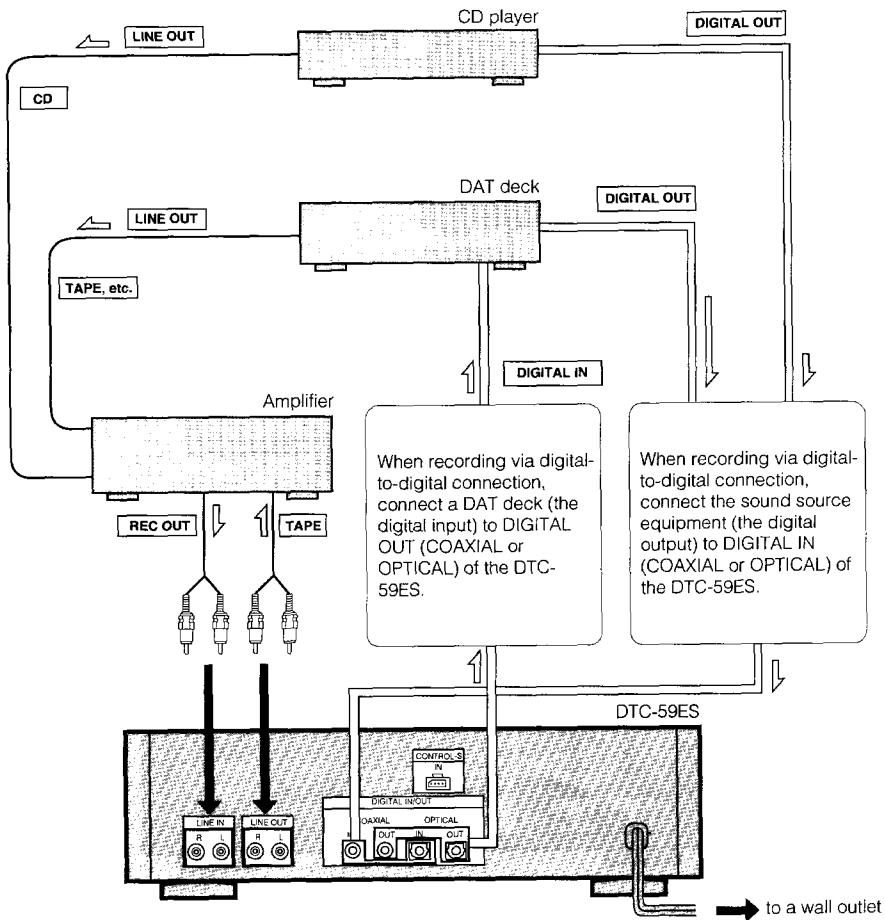

#### When connecting a microphone

Connecting a stereo microphone amplifier (the analog output) to LINE IN of the DTC-59ES.



#### Note

If "COPY PROHIBIT" appears in the display window, recording via digital-to-digital connection cannot be performed. In this case, connect the sound source equipment using LINE IN and OUT jacks.

# Connections

## Connection Examples

If your amplifier is equipped with digital signal jacks

-  : Analog signal
-  : Digital signal (coaxial cord or optical cable)
-  : Signal flow

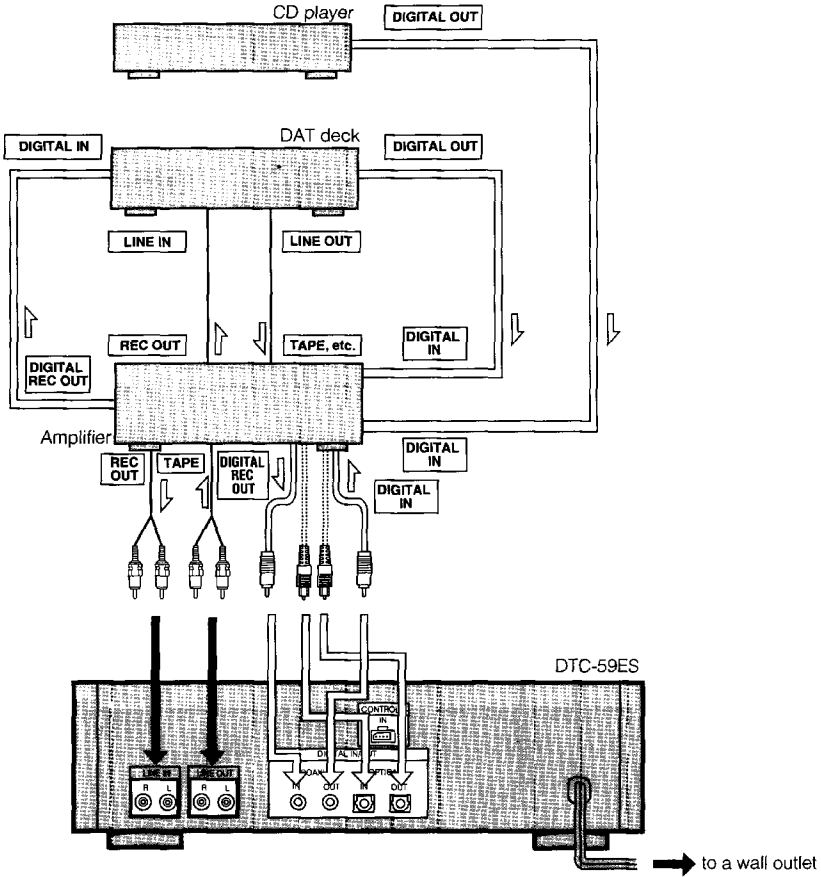

### Note

If "COPY PROHIBIT" appears in the display window, recording via digital-to-digital connection cannot be performed. In this case, connect the sound source equipment using LINE IN and OUT jacks.



# Clock Setting

This unit employs a built-in clock to keep track of the current date and time. Once you set the date and time, this information will be recorded on the tape along with the audio signal during recording. This function is very convenient because it allows you to check when the tape was recorded when playing the tape later.

## Setting the date and time

**Example:** Setting the clock to 10:30:00 AM, July 4, 1993 (Sunday)

### Setting the day

**1** Display the current date.

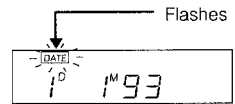

**2** Set the year.

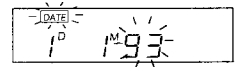
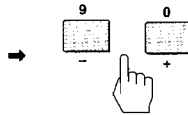

**3** Set the month.

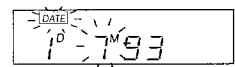
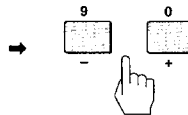

**4** Set the day.

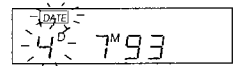
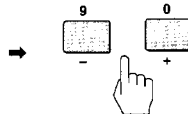

**5** Complete the setting procedure.

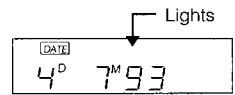

### Setting the day of the week

**1** Display the day of the week.

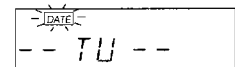

**2** Set the day of the week.

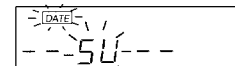
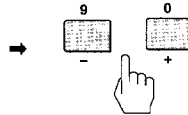

**3** Complete the setting procedure.

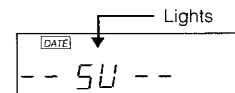

# Clock Setting

## Setting the time

**1** Display the current time.

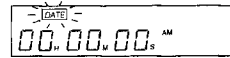

**2** Set the hour.

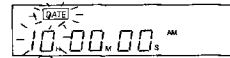
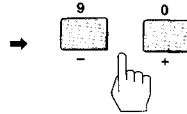

**3** Set the minutes.

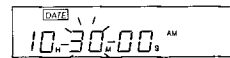
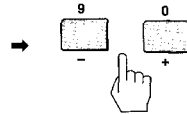

**4** Set the seconds to 0.

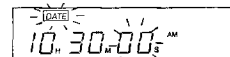
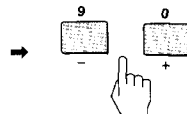

**5** Start the clock simultaneously with the signal from a timecast (telephone, etc.).



### To confirm the date or time

Press the PRESENT button to display the date, the day of the week or time. When pressing the PRESENT button once, the date is displayed, when pressing twice, the day of the week is displayed and when pressing three times, the time is displayed. To return to the original counter display, press the MODE button.

### Time display

The time is displayed in 12-hour format.  
Midnight and noon are displayed as follows:  
Midnight: 12:00 AM  
Noon: 12:00 PM

### Built-in clock

This unit's built-in clock operates using a quartz oscillator, and time variations caused by changes in temperature, etc., may accumulate. For precise recording of hour, minute, and second data by the built-in date function, it is recommended that you set the clock once a week.

### Precautions when setting the clock

- Set the clock while the tape is stopped.
- Although this unit's clock automatically adjusts for leap years and long and short months, do not enter a date which does not exist.

### The day of the week is displayed as follows:

|           |    |
|-----------|----|
| Sunday    | SU |
| Monday    | MO |
| Tuesday   | TU |
| Wednesday | WE |
| Thursday  | TH |
| Friday    | FR |
| Saturday  | SA |

### Note

This unit uses a back-up battery to keep the clock running when the power is turned off. The life of the battery under normal use is approximately seven years. When the battery starts to run down, the clock will stop operating normally. When this occurs, have the battery replaced at your dealer or nearest Sony Service Center (a battery replacement fee is required).

# Cassette Loading

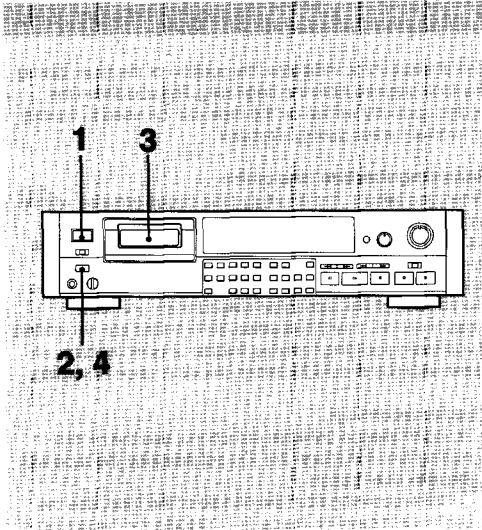

**1 Turn on the power.**

**2 Press  $\Delta$ OPEN/CLOSE.**  
The **OPEN** indicator appears on the display.

**3 Insert the cassette.**

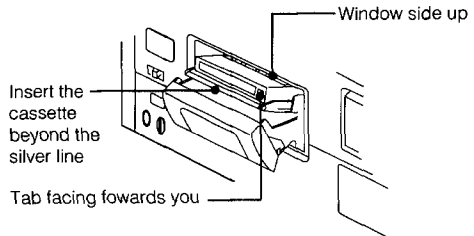

**4 Press  $\Delta$ OPEN/CLOSE.**  
The **CLOSE** indicator appears on the display.

**To remove the cassette**  
Press  $\Delta$ OPEN/CLOSE.

## On a digital audio tape

Only the digital audio tape made especially for DAT deck is required.

Unlike a conventional analog audio cassette tape, a digital audio tape can be used only one side.

- Digital audio tape is designed to avoid a dust. Do not open the inside of the tape.
- The hole at the back of a tape is a detector slot. Do not cover the slot.

## To prevent accidental erasure

When a recording is made, any previously recorded signal will be erased automatically. To prevent accidental erasure, set the safety tab to the position shown in the illustration.

With the hole open, rewriting sub codes cannot be performed.

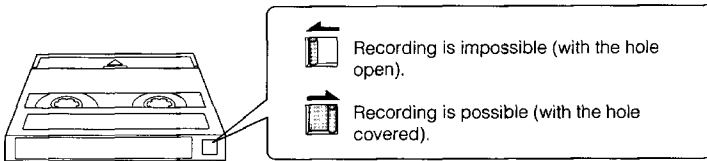

## Notes

- When you turn on the power, the **II** indicator flashes for a moment in the display window. During this period, no buttons other than the  $\Delta$ OPEN/CLOSE and  $\blacktriangleright$  buttons are operative. Wait until blinking stops and the **II** indicator goes off.
- When inserting the cassette, do not push the cassette compartment closed. Be sure to use the  $\Delta$ OPEN/CLOSE button.

## On the sampling frequency

When a cassette is inserted and a source program is played back, the sampling frequency (48 kHz, 44.1 kHz or 32 kHz) of the source program appears in the display window.

# Before Recording

## Blank Section and Sound Muted Portion

With conventional analog audio tapes, the tape portion on which no recording ever has been made and the portion on which a recording has been made but the sound is muted are treated the same, since no sound can be heard from these portions.

However, with DAT cassette, you should know that the two kinds of "no sound" portions must definitely be distinguished one from the other.

### Blank section

Means the portion on which no recording ever has been applied.

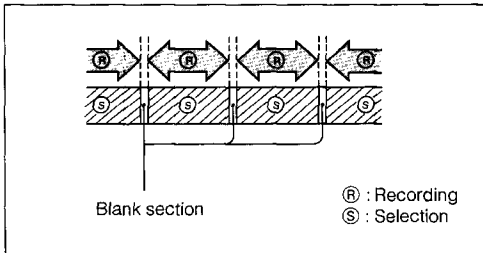

### Sound muted portion

Means the portion on which a recording has been applied but that no audible sound is recorded.

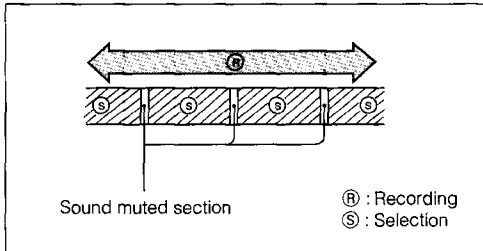

### Important

When recording, be certain that no blank section is left on the tape. If blank sections remain on the tape, search operations using the AMS buttons, for example, may take quite a long time or the absolute time is not written correctly.

### Difference between the blank section and sound-muted portion

When you record, a track format is constructed on the recorded area, even if the sound is muted during recording. On the blank section, since no recording is applied, there is no track format.

## Absolute Time Codes

The absolute time indicates the position of the tape, giving the time elapsed from the beginning. The absolute time codes correctly written on the tape can be used in various convenient ways during playback.

### Recording absolute time codes

When you record, the absolute time codes are also written automatically from the beginning of the tape.

Once the absolute time codes are recorded, it cannot be re-written. With the absolute time, you can check the elapsed time from the beginning of the tape or designate the position of the tape to be played back precisely.

Note, however, that the absolute time codes are not written if you start recording from the middle of blank section. No blank sections should be left on the tape when recording.

### Tips for recording:

- To insert silence between selections, use the record muting function (page 24). Do not advance the tape with the ► or ► button.
- To start recording from the middle of the tape, use the end search function (page 24) to locate the beginning of the blank section. This will avoid leaving a blank section.

### If a blank section is left on the tape

If you start recording from the middle of a blank section, the absolute time codes are not recorded, since the DAT deck can no longer count the absolute time from the beginning of the tape.

# Recording

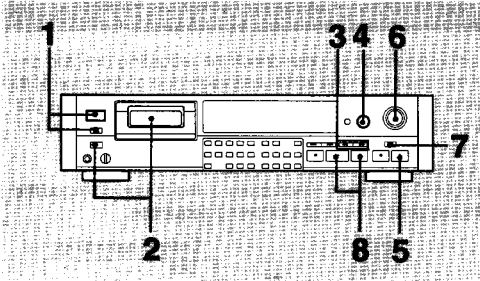

**1** Make sure that the **TIMER** switch is set to the **OFF** position, and turn on the power.

**2** Insert a cassette and press the **▲OPEN/CLOSE** button to load the cassette. (See page 19.)

**3** Locate the position at which you want to start recording.  
To start recording from the beginning of the tape, press the **◀◀** button. (Press the **◀◀** button again, the "TOP" indicator will appear at the beginning of the tape.)  
To start from the middle of the tape, locate the point immediately before the blank section with the end search function. (See page 24.)

**4** Set the **INPUT** selector to **ANALOG**, **OPTICAL** or **COAXIAL**, depending upon your sound source.

**5** Press the **●REC** button.  
**REC**, **▶** and **||** indicators light on the display, and the deck enters the record-pause mode. The sampling frequency to be applied for recording appears.  
**If the digital copy prohibit signal is written on the codes of the sound source, the COPY PROHIBIT indicator appears in the display window and signifies that you cannot record that source with the digital-to- digital connection. In this case, use the analog-to- analog connection.**

**6** When recording the analog input signal, adjust the recording level and balance with the **REC LEVEL** controls respectively. (See page 23.)  
No recording level adjustment is required when recording the digital input signal.

**7** To record in the long-play mode, set the **REC MODE** selector to the **LONG** position. (See page 23.)

**8** Press the **||PAUSE** or **▶** (play) button.  
The **||** indicator goes off, and recording starts.

**To write start ID automatically during recording**  
Make sure that the **AUTO** indicator is lit.  
If not, press the **START ID AUTO** button. (See page 28.)

**To designate the program number**  
Press the desired numeric button. (See page 30.)  
When recording from the beginning of the tape, the program number will be assigned automatically from 1.

**To insert sound muted portion at the beginning of the tape**  
Do not advance the tape with the **▶▶** or **▶** button. This will leave a blank section at the beginning. Be sure to proceed with the record muting function. (See page 24.)

**To stop recording**  
Press the **■** button.  
**To stop recording for a moment**  
Press the **||PAUSE** button.  
When you press the **FADER** or **OREC MUTE** button, the deck will also enter the record-pause mode.

**To release pause and restart recording**  
Press the **||PAUSE** or **▶** button.  
**To remove the cassette**  
Press the **▲OPEN/CLOSE** button.

**If recording cannot be made**  
Check the following:

- The safety tab of the cassette is not set to the record-possible position. (See page 19.)
- No cassette is loaded.
- The **INPUT** selector is set to the incorrect position.
- Tape is fully rewound to the end.
- The output level of the playback equipment is too low.
- The digital copy prohibit signal is written in the codes of the sound source you want to record. (The **COPY PROHIBIT** indicator appears in the display window.)
- The **REC LEVEL** controls are set to the 0 position. (Only when recording the analog input signal.)

**Note on the INPUT selector and the REC MODE selector**  
Do not change the position of these selectors after recording starts.

**If the cassette is ejected after it has been loaded**  
Check to see if the cassette is inserted correctly. (See page 19.)

**When the tape is recorded to the end (Auto rewind function)**  
The tape is rewound to the beginning and stops automatically.

The auto rewind function is not applied when the **TIMER** switch is set to the **REC** position.

**Accuracy of the electronic linear time counter**  
The linear time counter provided with this unit is not a clock. The time indicated by the counter may differ slightly from the actual recording/playback time.

# Recording

## To Store the Recording Date and Time

Once the built-in clock is set, the day, the day of the week and time of recording will automatically be recorded on the tape along with the audio signal. When playing the tape back later, you can display this information to check when the tape was recorded.

To check the day, the day of the week and time being recorded, press the PRESENT button to display the current date and time.

### Note

If you use another DAT deck to record subcodes (using the renumbering function, etc.) on a tape initially recorded on this unit, the recording date and time data may be erased from those sections of the tape.

## To Check the Recording Date and Time

During playback you can check the recording day, the day of the week and time which was recorded on the tape at the same time the audio signal was recorded. (No display will appear if the recording date and time are not recorded on the tape.)

To display the recorded date and time, press the RECORDED button. Each press of the button changes the display according to the following sequence.

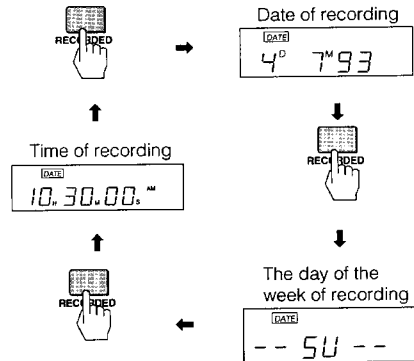

### To check the current date and time

Press the PRESENT button. The day, the day of the week and time are displayed in the same way as with the RECORDED button.

**Recording level adjustment (for analog input signals only)**

The peak level meters have a peak hold function which indicates the peak level of the analog input signal momentarily. The MARGIN indicator shows how much margin there is between the peak level of the input audio signal and 0 dB. Whenever a signal having a higher level than the displayed one is input, the new level replaces the lower one on the MARGIN indicator. Turn the REC LEVEL controls so that the "OVER" segments do not light, even at the highest level.

**To reset the margin**

Press MARGIN RESET. The margin will become "-".

**If the level exceeds 0 dB**

The "OVER" segments light in red, and "0.0 dB" flashes. If "OVER" lights steadily, lower the recording level so that the peak level meter lights between -12 dB (12) and 0 dB to avoid sound distortion.

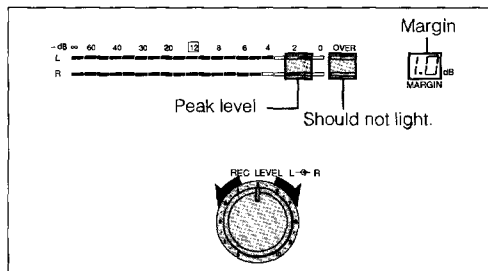

**If you keep adjusting the recording level with the unit in the record-pause mode**

If the unit is left in the record-pause mode for more than 10 minutes, the record-pause mode will be released automatically, and the unit will enter the stop mode. The levels of the input audio signals appear even in the stop mode, and you can continue to adjust the recording level. (The "AD-DA" indicator appears on the display.) In the above case, press the ●REC button again to set the unit to record-pause mode.

**If the unit is left in the record-pause mode for more than 10 minutes during digital recording**

The record-pause mode will be released automatically, and the unit will enter the stop mode. (The "-DA" indicator appears on the display.) In this case, press the ●REC to set the unit to record-pause mode.

**If the cable is disconnected or the program source is intermitted, the digital input signal will be interrupted during digital recording**

The OPTICAL or COAXIAL indicator flashes and the unit will enter record-pause mode. (For about 10 minutes) If the digital signal is input again in this period, the unit will enter recording mode automatically.

**Long-play mode**

According to the input signal, recording/playback in the long-play mode can be performed as follows.

| Input signal                          | Recording mode (position of the REC MODE selector) |  |
|---------------------------------------|--|--|
|                                       | STANDARD   | LONG                                     |
| Analog input signal                   | standard play (48 kHz)                             | long play (32 kHz)                       |
| Digital input signal 32 kHz*          | standard play (32 kHz)                             | long play (32 kHz)                       |
| Digital input signal 44.1 kHz, 48 kHz | standard play (the same as input signal)           | standard play (the same as input signal) |

( ): sampling frequency

The digital input signal on 44.1 kHz or 48 kHz cannot be recorded/played back in the long play mode, even if the REC MODE selector is set to the LONG position.

\* When analog input signal with 32 kHz or 48 kHz is recorded via digital-to-digital connection.

**The longest recording period at each mode**

| Cassette / Mode | The longest recording period |      |
|-----------------|------------------------------|------|
|                 | standard                     | long |
| DT-120          | 2h                           | 4h   |
| DT-90           | 1h 30m                       | 3h   |
| DT-60           | 1h                           | 2h   |

(h: hour, m: minute)

**The timer counter in the long-play mode**

Tape running time, absolute time and total remaining of the tape appears, based on those in the standard mode. To obtain the actual time, double each value.

# Recording

## Creating a Sound Muted Portion (Record Muting)

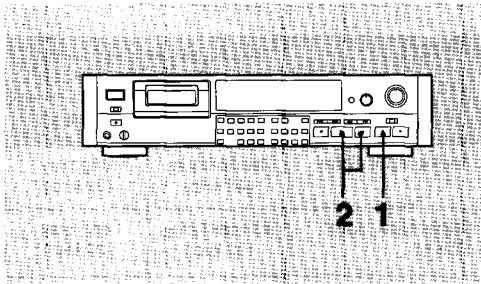

**1** During recording or record-pause mode, press the **OREC MUTE** button where a sound muted portion is required.

The **[REC]** indicator flashes and the record muting is activated. After about 4 seconds, the **[REC]** indicator shows a steady light, and the **II** indicator lights. The deck enters the record-pause mode.

**2** To resume recording, press the **II PAUSE** or **▶ (play)** button.

Recording resumes.

### Using sound muted portion

If you intend to dub the DAT cassette onto an analog cassette tape, we recommend that you insert sound muted portions between selections on the DAT cassette. This will ensure that the AMS function of the analog cassette deck works correctly for the recorded tape.

#### Note

With DAT deck, the AMS function is realized by using the start ID code. (See page 27.)

#### Caution

To place a space on a DAT cassette, you must not advance the tape with the **▶▶** or **▶** button. If a space is created this way, no absolute time code will be recorded on the succeeding area, and you cannot check the elapsed time of the tape.

#### To create a sound muted portion of more than 4 seconds

Keep the **OREC MUTE** button pressed for as long as you want to make a recorded portion with no signals. After about 4 seconds, the **[REC]** indicator flashes rapidly. When you release the **OREC MUTE** button, the deck enters the record-pause mode. The interval between selections is indicated in the MARGIN display.

#### To create a sound muted portion of less than 4 seconds

Press the **OREC MUTE** button, and then the **II PAUSE** button while the **REC** indicator is flashing.

#### To start recording in the rec mute mode

Press the **●REC** button while the **[REC]** indicator is flashing.

## End Search

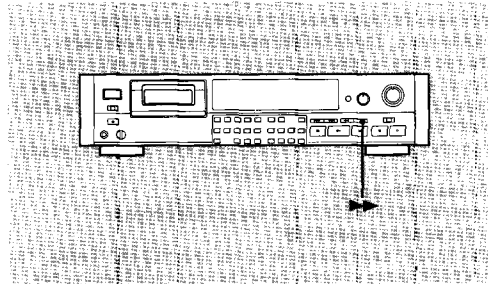

If the previous recording was applied to the middle of the tape, you must locate exactly the last point of the recorded area, and start the new recording from this point. This will prevent leaving a blank section on the tape.

If you want space between the last recording and the new recording, use the **OREC MUTE** button to mute the sound.

Press **▶▶**.

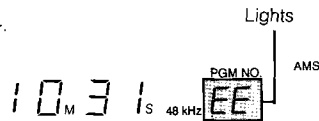

The last point of the previous recording (the beginning of the blank section or the beginning of the end ID\*) is located, and the tape stops. When the end ID is detected, the "EE" indicator lights at the PGM. NO display.

#### Note

If the point where you pressed the **▶▶** button is blank, the end search operation will not function.

#### When the end ID is written before a blank section

\* The end search operation stops at the beginning of this end ID as illustrated below.

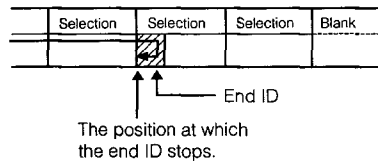

#### Note on the duration of a blank section

The blank section must last for more than 9 seconds for the end search operation to function correctly.



## Fade-in/Fade-out Recording

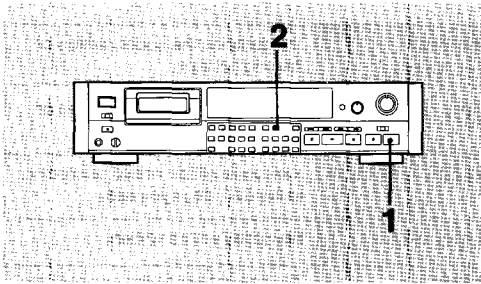

### Fade-in recording

- 1 Press the **REC** button at the starting point of recording.**  
The deck enters the record-pause mode.
- 2 Press the **FADER** button at the point where you want to start fading in.**  
The **FADE** indicator flashes, and the sound fades in. To return to the original volume level, immediately during a fade-in recording, press the **REC** button.

### Fade-out recording

#### Press the **FADER** button at the point where you want to start fading out.

The **FADE** indicator flashes, and the sound being recorded fades out.

A countdown starts, and the deck enters the record-pause mode after the 0.0s indicator appears.

#### To enter the record-pause mode immediately during a fade-out recording

Press the **PAUSE** button.

#### To designate a desired duration of fade-in/fade-out

You can designate a desired duration of fade-in/fade-out, from 1.0 seconds to 15 seconds. Fade-in/fade-out is performed in 5 seconds unless you designate a different duration.

If you turn off the unit after designating the desired duration of fade-in/fade-out, the duration remains memorized.

- 1 Choose either **FADE IN** or **FADE OUT** by pressing the **FADER** button in the stop mode.**
- 2 Designate a desired duration by pressing **◀◀** or **▶▶**.**  
Each time pressing **◀◀** or **▶▶**, a duration in the display changes as follows:  
from 1.0 sec. to 3.0 sec.: in 0.2 sec. intervals  
from 3.0 sec. to 5.0 sec.: in 0.4 sec. intervals  
from 5.0 sec. to 15 sec.: in 1 sec. intervals.

## CD Synchronized Recording

If a Sony compact disc player with a remote commander is available, you can start playback of the CD player and the recording of the DAT deck simultaneously, with the remote commander of the DAT deck.

Position the remote commander so that the signal reaches the remote sensor of both the DAT deck and the CD player.

### To start recording

This function can be performed only with the remote commander.

- 1 Insert a cassette.**
- 2 Insert the disc in the CD player.**
- 3 Press the **CD SYNCHRO STANDBY** button on the remote commander of the DAT deck.**  
The deck enters the record-pause mode.
- 4 Press the **CD SYNCHRO START** button on the remote commander of the DAT deck.**  
Recording on the DAT deck starts, and about 1 second later, playback of the CD player starts.

### To stop recording

Press the **CD SYNCHRO STOP** button on the remote commander of the DAT deck.

#### Note

To momentarily stop recording of the DAT deck and playback of the CD player simultaneously, press the **PAUSE** buttons on both the DAT deck and the CD player.

#### To control the CD player with the remote commander of the DAT deck

The following operations are possible:

Playback: Press the **PAUSE** button twice.

Pause: Press the **PAUSE** button once.

AMS: Press the **◀◀** or **▶▶** button.

When a desired selection is located using the above operation, you can start CD synchronized recording.

CD operating buttons

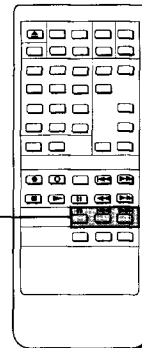

# Sub Codes

In addition to the ordinary audio signals, various control codes called sub codes can be recorded on the DAT cassette tapes to ease recording and reproducing operation.

A desired selection can be called up or time information can be displayed using the sub codes, for example. The sub codes such as start ID, program number, skip ID, end ID and program time, absolute time and date function (recording the date) are available on this unit.

- Sub codes are written on the tape separately from the audio signals, so the audio signals are not affected.
- Sub codes, except the absolute time and the date function, can be rewritten after the audio signal recording has been completed. The recorded audio signals are not affected by the rewritten sub codes.

- When you record the tape with sub codes written onto a new tape via digital-to-digital connection, the sub codes to be written on the new tape are following:

|                        |   |
|------------------------|---|
| <b>Start IDs</b>       | The same as the codes written on the original tape.         |
| <b>Skip IDs</b>        | The same as the codes written on the original tape.         |
| <b>Program Numbers</b> | New ones will be written according to the DAT deck you use. |
| <b>Absolute time</b>   | New ones will be written.                                   |
| <b>End ID</b>          | The one written on the original tape will not be written.   |
| <b>Date function</b>   | The one written on the original tape will not be written.   |

When you use analog-to-analog connection, no sub codes on the original tape will be written onto a new tape. New codes will be written according to the DAT deck you use.

### Start ID

This signal indicates the start of a music selection. You can locate the position of the start ID precisely. This signal should be written at the beginning of the selection.

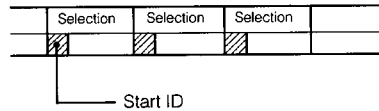

### Program number

This signal gives a number to selection. You can record it where the start ID is written. By designating this number, you can choose the desired selection directly or program selections in a desired order.

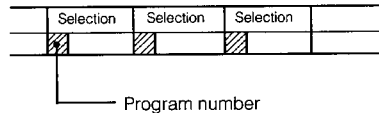

### Skip ID

This signal can be marked on the selection wherever you wish. When the SKIP PLAY indicator is lit during playback, the deck will skip at high speed from where the skip ID is marked to the next start ID, and then playback will start again. Record this skip ID at the beginning of portion you want to skip.

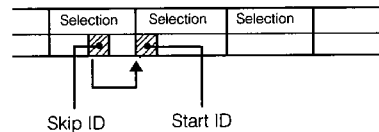

### End ID

This signal indicates the end position of a recording.

- ① When you do not want to listen to the very end of a tape, record the end ID at the beginning of the portion you do not want to play. When the end ID is detected during playback, playback stops and the tape is rewound to the beginning automatically.
- ② When recording new material on a recorded tape, you can write an end ID at the end of the re-recorded portion. This will help you easily find the position to start recording the next time when you want to record other material onto the same tape. Like a start ID or skip ID, end ID can also be erased later.
- ③ When an end ID which has been written is detected during locating selections or rehearsal playback of start ID or skip ID, the unit stops at the beginning of the end ID.

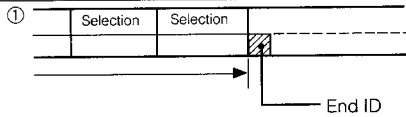

During playback, the tape is automatically rewound to the beginning.

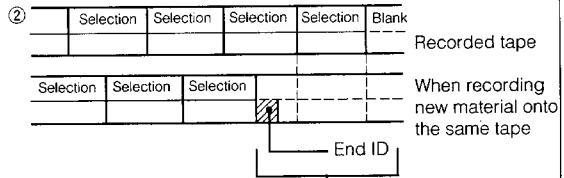

Portion where you have not made a second recording (This first recording has not been erased.)

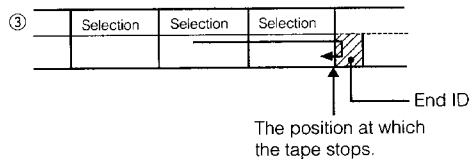

### Absolute time

The absolute time indicates the position of the tape, giving the time elapsed from the beginning. The absolute time is recorded automatically at the same time the audio signal is recorded. It cannot be re-recorded. The absolute time allows you to confirm the elapsed time from the beginning of the tape.

### Program time

This is the time elapsed for a selection.

### The date function (Recording a date)

With the built-in clock, the day, the day of the week and time of recording are automatically recorded.

### When using the sub codes

| Things that can be done  | Required sub code(s)                 |
|--|--------------------------------------|
| Locating a selection (AMS function)                                    | Start ID                             |
| Listening to the first portion of selections sequentially (Music Scan) | Start ID                             |
| Choosing a selection directly  | Start ID/Program number              |
| Programming desired selections in a desired order (RMS play)           | Start ID/Program number              |
| Skipping the portion not desired                                       | Skip ID/Start ID                     |
| Looking for the position at which the recording or playback ends       | End ID                               |
| Checking the recording date and time                                   | Date (It is recorded automatically.) |

# Start ID

The start ID indicates the beginning of each selection. You can start playback from the start ID position. (See page 26 for details.)

There are three ways to write start ID:

- Writing automatically during recording
- Writing manually at the desired position during recording
- Writing manually at the desired position during playback

## Note

While the start ID is being written, all buttons except the ■ button are not operative.

## Writing Automatically during Recording

### 1 Make sure that the AUTO indicator is lit. If it is not, press the START ID AUTO button.

When turning on the power and inserting a cassette with its safety tab at the record-possible position, the AUTO indicator lights automatically.

In time recording, this indicator will be the same as the one before the power is turned off. Start IDs will be recorded automatically when the AUTO indicator lights.

### 2 To start recording, press the ●REC button, then press the II PAUSE or ► (play) button.

When the non-signal level lasts for more than 3 seconds and a selection then starts, the start ID is written for 9 seconds (18 seconds in the long-play mode).

While a start ID is being written, the START ID indicator blinks on the display.

## Why 9 seconds or 18 seconds are necessary for writing a start ID ?

A start ID requires 9 or 18 seconds to allow to be detected when rewinding/fast-forwarding a tape. (The speed is 200 times as fast as that of normal tape operation.)

After the start ID is located, the tape returns to the beginning of the start ID if necessary, and playback starts from the beginning of the selection.

## If the signal level stays very low for more than 3 seconds

If there is a portion of very low volume level during a selection, a start ID may be written even in the middle of the selection. An unwanted start ID can be erased later. (See page 29).

## When the portion between selections is not clear

The start ID position may not coincide exactly to the beginning of the selection. To shift the start ID position, see "Shifting Start IDs" and Program Numbers Position" on page 31.

## Illustration of writing a start ID

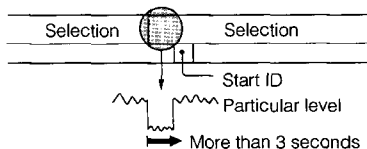

## When recording from a CD player

If the auto space function is available with your CD player, activate this function to ensure that the start IDs are written correctly.

## Writing Manually during Recording

### 1 Make sure that the AUTO indicator is off. If it is not, press the START ID AUTO button to turn it off.

### 2 To start recording, press the ●REC button, then press the II PAUSE or ► (play) button.

### 3 At the desired position, press the START ID WRITE button.

The WRITE indicator lights.

The start ID is written for 9 seconds (18 seconds in the long-play mode) from the point where you pressed the START ID WRITE button. While a start ID is being written, the START ID indicator flashes.

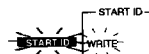

## Writing Manually during Playback (Rehearsal function)

During playback, start ID can be written at the desired position more accurately than during recording. Make sure that the safety tab of the cassette is closed.

- 1 Press the ► button to start playback. At the desired position, press the START ID WRITE button. The REHEARSAL indicator lights and the WRITE and START ID indicators flash, and the position for 3 seconds from the point where you pressed the START ID WRITE button is played back repeatedly (rehearsal function). The beginning of the repeated portion will be the beginning of the start ID.

- 2 Press the ◀◀ or ▶▶ button to adjust the "repeat start" point. The "repeat start" point is shifted backward with the ◀◀ button or forward with the ▶▶ button by about 0.3 of a second. The indicator at the MARGIN display shows how much the "repeat start" point is shifted from the point where you pressed the START ID WRITE button.

- 3 After setting the beginning of the start ID at the desired point, press the START ID WRITE button again. The WRITE indicator lights steadily and the start ID is written. The program number is not written in this time.

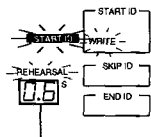

When you pressed ►► twice.

### Illustration of the rehearsal function

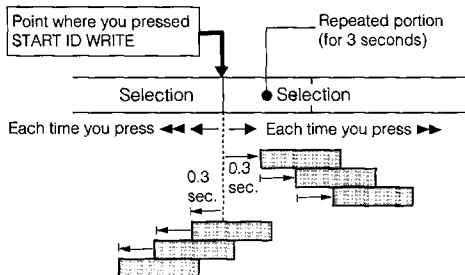

Normally, the repeated portion is played back 5 times. When the ◀◀ or ▶▶ button is pressed while the repeated portion is played back, the repeated portion is played back up to 8 times max, and then tape stops.

## Adjusting the Position

To finely adjust the position of a start ID written automatically during recording, use the rehearsal function described on the left column.

You can shift the start ID position about 2 seconds (about 4 seconds in the long-play mode) backward or forward. To shift it for more than 2 seconds, first erase the start ID (see below) and rewrite it manually.

- 1 During playback, press the START ID WRITE button where the start ID to be shifted is written.
- 2 Perform steps 2 and 3 described on the left column, "Writing Manually during Playback."

## Erasing

While the start ID you want to erase appears on the display during playback or in the stop mode, press the START ID ERASE button. Make sure that the safety tab of the cassette is closed.

That start ID is erased.

The ERASE indicator flashes while the start ID is detected. While the start ID is being erased, the ERASE indicator lights and the START ID indicator flashes.



If you press the START ID ERASE button during the stop mode or while the START ID indicator is not on the display

The start ID just before the current position is erased.

### When a start ID is erased

If a program number is also written with the start ID, both codes will be erased at the same time.

# Program Numbers

Program numbers are the codes indicating the selection order. (See page 26 for details.)

There are two ways to write program numbers:

- Writing automatically during recording
- Renumbering automatically during playback or in the stop mode (Renumbering function)

## Writing Automatically during Recording

When you proceed so that start IDs are written automatically during recording, the program numbers are also written.

### Writing program numbers from the beginning of the tape

- 1 The AUTO Indicator must be lit. If it is not, press the START ID AUTO button.**  
When turning on the power and inserting a cassette with its safety tab at the record-possible position, the AUTO indicator lights. In timer recording, the AUTO indicator will be the same as the one before the power is turned off.
- 2 To start recording, press the ●REC button, then press the II PAUSE or ► (play) button.**  
The program numbers will be written in numerical order from "1" at the same position as the start IDs.

### Writing program numbers from the middle of the tape

- 1 To locate the last point of the previous recording, using the end search function. (See page 24)**  
It is important to proceed with the end search function in order not to leave a blank section on the tape.
- 2 The AUTO Indicator must be lit. If it is not, press the START ID AUTO button.**  
When turning on the power and inserting a cassette with its safety tab at the record-possible position, the AUTO indicator lights.  
In timer recording, the AUTO indicator will be the same as the one before the power is turned off.
- 3 Press the ●REC button to set the deck in the record-pause mode.**

- 4 Designate the next program number (the number that follows the program number of the last selection) with the numeric button.**  
If you are not aware of the program number, press the I◀ button to check the last program number (After checking the program number, locate the last point of the previous recording, using the end search function.)  
If the program number of the last selection appears at the PGM NO. display, you need not to designate the next number.

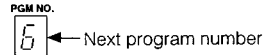

- 5 Press the II PAUSE or ► (play) button.**  
The program numbers are written for about 9 seconds (about 18 seconds in the long-play mode) consecutively, beginning from the designated number.

**If the next program number is not designated in step 4**  
The start IDs will be written, but the program numbers will not.  
You can write the program numbers using the renumbering function described on the next page.

## Renumbering

If you record from the beginning to the middle of a tape on which another recording has ever been applied, the same program number may be written twice on that tape. If you omit designating the next program number when recording from the middle of the tape, the succeeding program numbers are not written.

In such cases, proceed as follows to renumber the program numbers from the beginning of the tape at a high speed.

### Renumbering Program Numbers Automatically

- 1 Make sure that the AUTO indicator is lit, and that the safety tab of the cassette is at the record-possible position.**

If the AUTO indicator is not lit, press the START ID AUTO button.

- 2 Press the RENUMBER button during playback or in the stop mode.**

The tape will automatically be rewound to the beginning, and the program numbers are re-arranged from "1" in numerical order at each start ID position. While the program numbers are rewritten, the **START ID** indicator flashes, and while the tape is fast-forwarded to the next start ID, the AUTO RENUMBER indicator flashes.

When program numbers are written correctly, the tape is fast-forwarded to the next start ID.

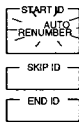

### When renumbering is terminated

The tape is automatically rewound to the beginning, and the deck enters stop mode.

## Shifting Start IDs' and Program Numbers Position

The start ID position may not coincide exactly to the beginning of the selection, especially when the portion between selections is not clear. On such a tape, the very beginning of the selection cannot be located using the AMS function. If this happens, you can shift the start ID and program number position, however, you cannot shift the position of the program number 1.

- 1 Make sure that the AUTO indicator is off, and that the safety tab of the cassette is at the record-possible position.**

If the AUTO indicator is lit, press the START ID AUTO button.

- 2 Press the RENUMBER button during playback or in the stop mode.**

The start ID and program number position of the 2nd selection, and the succeeding selections, will be shifted forward by about 0.3 of a second.

When program numbers are written incorrectly, the renumber function operates.

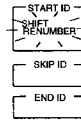

## Erasing

Make sure that the safety tab of the cassette is closed.

**During playback, press the START ID ERASE button while the program number to be erased appears in the display window.**

That program number is erased. The start ID at the same position will also be erased.

The ERASE indicator flashes while the program number is being searched for, and the **START ID** indicator flashes while the program number is being erased.

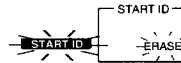

### When the program number is erased

Playback continues. The succeeding program numbers remain unchanged. To re-arrange the program numbers, renumber them as described on the left column.

# Skip ID

When the skip ID is detected during playback, the tape skips to the next start ID position, and the normal playback resumes. (See page 26 for details.)

## Writing during Recording

Press the **SKIP ID WRITE** button at the beginning of the portion you want to skip later.

The **SKIP ID** and **WRITE** indicators light momentarily. The skip ID is written for about 1 second (2 seconds in the long-play mode) from where you pressed the button.



## Writing during Playback (Rehearsal function)

During playback, skip ID can be written at the desired position more accurately than during recording. Make sure that the safety tab of the cassette is closed.

**1** During playback, press the **SKIP ID WRITE** button at the desired position.

The **REHEARSAL** indicator lights and the **WRITE** indicator flashes, and the portion for 3 seconds to the point where you pressed the **SKIP ID WRITE** button, is played back repeatedly (rehearsal function).

The end of the repeated portion will be the beginning of the skip ID.

**2** Press the **◀◀** or **▶▶** button to adjust the "repeat end" point.

The "repeat end" point shifted backward with the **◀◀** button or forward with the **▶▶** button by 0.3 of a second.

The indicator at the **MARGIN** shows how much the "repeat end" point is shifted from the point where you pressed **SKIP ID WRITE**.

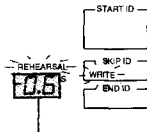

When you pressed **◀◀** twice.

**3** After setting the beginning of the skip ID at the desired point, press the **SKIP ID WRITE** button again.

The **SKIP ID** indicator lights, and the skip ID is written.

## Note on the point where a skip ID is written

During rehearsal function, a skip ID will be written at the end of the repeated portion as illustrated.

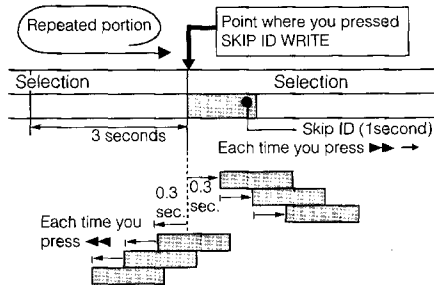

Normally, the repeated portion is played back 5 times. When the **◀◀** or **▶▶** button is pressed while the repeated portion is played back, the repeated portion is played back up to 8 times max, and then tape stops.

## Erasing

Make sure that the safety tab of the cassette is closed.

During playback or in the stop mode, press the **SKIP ID ERASE** button immediately after the skip ID to be erased.

The tape is rewound to the nearest skip ID position and the skip ID is erased.

The **ERASE** indicator lights while the skip ID is being searched for and goes off when the skip ID is erased.

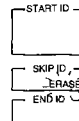

## Precaution

When the skip ID and the start ID are overwritten, the skip ID will also be erased if the start ID is erased.

| ID to be erased   | Operation                               |
|-------------------|---|
| Start ID, skip ID | Press the <b>START ID ERASE</b> button. |
| Skip ID           | Press the <b>SKIP ID ERASE</b> button.  |



# End ID

The end ID indicates the last position of the recording or playback. While recording on the same tape has been done several times, you can locate the point where the previous recording terminates quickly, using the end ID. When the end ID is detected during playback, the playback stops and the tape is rewound to the beginning automatically.

## Writing during Recording

### 1 Press the **II PAUSE**, **OREC MUTE** or **FADER** button.

| The button you pressed | The mode of the deck  |
|------------------------|---|
| II PAUSE               | Record-pause mode   |
| OREC MUTE              | Record-pause mode after a sound muted portion is created for 4 seconds. |
| FADER                  | Record-pause mode after the sound fades out.                            |

### 2 Press the **END ID WRITE** button.

The END ID WRITE indicator lights.

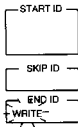

### 3 Press the **II PAUSE** or **▶ (play)** button to release the record-pause mode.

The "EE" indicator appears on the display. The end ID is written for about 9 seconds (18 seconds in the long-play mode). Tape returns to the beginning of the end ID after the end ID is written.



### After you write an end ID

The portion after the end ID position cannot be played back. (The "EE" indicator appears at the PGM NO. display.) Erase the end ID (page 34) where you want to play back the portion after the end ID position.

## Writing during Playback (Rehearsal function)

- During playback, no end ID can be written on a blank section.
- To write the end ID just before a blank section with the end search function, perform "Writing during Recording" described on the left columns.
- Make sure that the safety tab of the cassette is closed.

### 1 During playback, press **END ID WRITE** at the desired position.

The REHEARSAL indicator lights and the WRITE indicator flashes, and the portion for 3 seconds to the point where you pressed the END ID WRITE button, is played back repeatedly (rehearsal function). The end of the repeated portion will be the beginning of the end ID.

### 2 Press the **◀◀** or **▶▶** button to adjust the "repeat end" point.

The "repeat end point is shifted backward with the **◀◀** button or forward with the **▶▶** button by 0.3 of a second.

The indicator at the MARGIN display shows how much the "repeat end" point is shifted from the point where you pressed the END ID WRITE button.

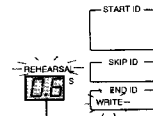

When you pressed **▶▶** twice

### 3 After setting the beginning of the end ID at the desired point, press the **END ID WRITE** button again.

The "EE" and WRITE indicators light, and an end ID is written.

### Note on the point where an end ID is written

During rehearsal function, an end ID is written at the end of the repeated portion as illustrated.

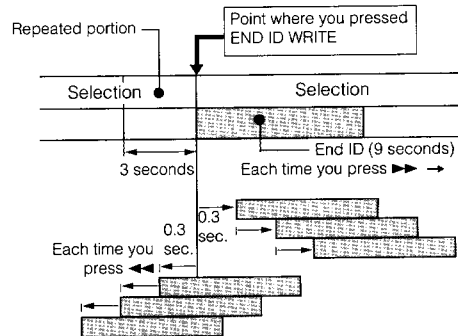

Normally, the repeated portion is played back 5 times. When the **◀◀** or **▶▶** button is pressed while the repeated portion is played back, the repeated portion is played back up to 8 times max, and then tape stops.

# End ID

## Erasing

Make sure that the safety tab of the cassette is closed.

- 1 Search for the beginning of the end ID with the ►► button. (See page 24.)**  
When the end ID is detected, the "EE" indicator lights.
- 2 Press the END ID ERASE button.**  
The END ID ERASE indicator lights while the end ID is being searched for and then goes off when the end ID is erased.

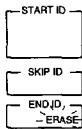

# Playback Playback

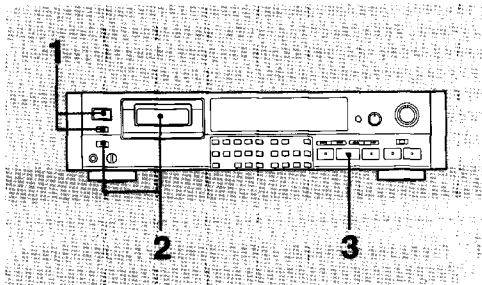

- 1 Make sure that the TIMER switch is set to the OFF position, and then turn on the power.**
- 2 Insert the cassette and press the ▲OPEN/CLOSE button to load the cassette.**
- 3 Press the ► (play) button.**  
Playback begins.  
If an end ID is written on the tape, playback stops automatically at the end ID position, and the tape will be rewound to the beginning.



005s

### To control tape transport

|                                       |  |
|---------------------------------------|--|
| To stop playback                      | Press the ■ button.                          |
| To stop playback for a moment         | Press the III PAUSE button.                  |
| To release pause and restart playback | Press the III PAUSE or ► button.             |
| To remove the cassette                | Press the ▲ OPEN/ CLOSE button.              |
| To rewind or fast-forward the tape    | Stop the tape and press the ◀◀ or ►► button. |

### Cue/review operation

|                             |                                      |  |
|-----------------------------|--------------------------------------|--|
| To advance the tape (cue)   | Press the ►► button during playback. | Sound is heard while the button is pressed. Release the button at the desired point. Playback resumes. |
| To rewind the tape (review) | Press the ◀◀ button during playback. |  |

The speed of the tape increases about 4 seconds after the cue or review starts.

## Display Window

Each time you press MODE, the counter changes as follows.

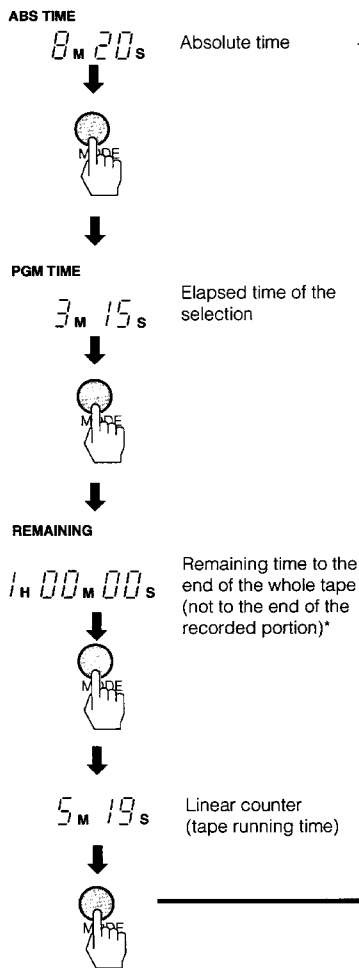

### Notes

- At the beginning of the tape, "⏮" may appear and immediately go off at the PGM NO. indicator position depending on some types of pre-recorded tapes. ("⏮" stands for "beginning".)
- To reset the counter to 0M 00S, press RESET on the remote commander.

\* When playing back a pre-recorded tape (software), remaining time to the end of the recorded portion appears.

## To check the sampling frequencies recorded on the tape — Frequency Map

Press the 4 button on the numeric buttons while keeping the MODE button pressed.

Bars on the level meter light to signify the sampling frequencies with which the material was recorded. (No bars light until 16 seconds (32 in the long-play mode) after playback starts.)

| Sampling frequency | Level meter to be lit     |
|--------------------|---------------------------|
| 32 kHz             | Upper bar                 |
| 44.1 kHz           | Both upper and lower bars |
| 48 kHz             | Lower bar                 |

"TOP", "MID" and "END" indicate the beginning, middle and end of each tape respectively.

Example:

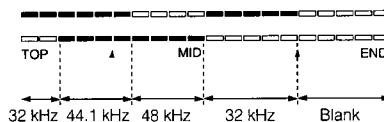

## To return to the peak level meter display

Press the 4 button while keeping the MODE button pressed again.

## Elapsed time of the selection does not appear when...

- The selection is played back from the middle.
- The tape is being fast-forwarded or rewound.
- The cassette compartment is opened or closed by the  $\blacktriangle$  OPEN/CLOSE button.

## Adjusting the headphones volume

Use the PHONES-LEVEL control.

## When the tape is played back to its end

The tape will be rewound to the beginning and stop automatically.

## Remaining time does not appear in the following cases

- Immediately after the deck is set in the playback mode. The remaining time will appear about 16 seconds (in the standard-play mode) later.
- When playback is started from a blank section (page 20), the remaining time may not appear. Press the  $\blacktriangleleft$  or  $\blacktriangleright$  button.

## Accuracy of the indicator for the remaining time

This unit indicates the remaining time by referring the thickness of the tape. So the remaining time may differ from the actual remaining time according to the type of tape.

## If tape noise exists, or sound quality has deteriorated

The head may be contaminated. Clean the head, using a cleaning cassette (See page 41).

# Various Playback Operations

## Fade-in/Fade-out Play

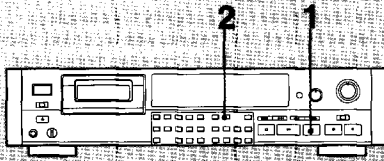

Fade-in/fade-out play cannot be performed through the digital output jack.

### Fade-in Play

- 1** During playback or in the stop mode, press the **PAUSE** button.  
The deck enters the pause mode.
- 2** Press the **FADER** button.  
The **FADER** indicator flashes, and the sound fades in.

### Fade-out Play

During playback, press the **FADER** button at the point where you want to start fading out.  
The **FADER** indicator flashes, and the sound being played back fades out.  
A countdown starts, and the deck enters the pause mode after the 0.0s indicator appears.

### To designate a desired duration of fade-in/fade-out

You can designate a desired duration of fade-in/fade-out, from 1.0 seconds to 15 seconds.  
Fade-in/fade-out is performed in 5 seconds unless you designate a different duration.  
If you turn off the unit after designating the desired duration of fade-in/fade-out, the duration remains memorized.

- 1** Choose either **FADER** or **FADER** by pressing the **FADER** button during the stop mode.
- 2** Designate a desired duration by pressing the **◀** or **▶** button.  
Each time pressing the **◀** or **▶** button, a duration in the display changes as follows:  
from 1.0 sec. to 3.0 sec.: in 0.2 sec. intervals  
from 3.0 sec. to 5.0 sec.: in 0.4 sec. intervals  
from 5.0 sec. to 15 sec.: in 1 sec. intervals

## Repeat Play

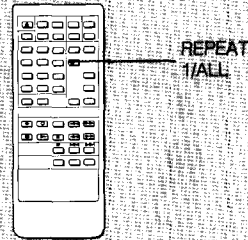

These functions can be performed only with the remote commander.

### Playing a Selection Repeatedly

Press the **REPEAT 1/ALL** button on the remote commander while the desired selection is played back. The **REPEAT 1** indicator appears.  
After the selection is playback, the tape is rewound to the beginning of that selection, and the playback is repeated.

### To stop playing a selection repeatedly

Press the **REPEAT 1/ALL** button until the **REPEAT** indicator goes off.

### Note on the end of the repeated portion during the REPEAT 1 play

The tape is rewound to the beginning of the selection to be repeated when one of the following is detected.

- Start ID of the next selection
- A blank section of more than 9 seconds
- End of the tape
- Skip ID with **SKIP PLAY** activated

### Number of times to be repeated

The selection to be repeated will be played back 5 times, and then the tape will stop.

### Playing all selections repeatedly

During playback, press the **REPEAT 1/ALL** button until the **REPEAT ALL** indicator appears on the display.  
After the tape is played back to the end, it is rewound to the beginning and the playback of all selections is repeated. In the **RMS** play (page 39), all the selections programmed are played back repeatedly.

### To stop playing all selections repeatedly

Press the **REPEAT 1/ALL** button until the **REPEAT** indicator goes off.

### Note on the end of the repeated portion during the REPEAT ALL play

The tape is rewound to the beginning of the tape when one of the following is detected.

- End ID
- A blank section of more than 9 seconds

## Automatic Music Sensor Operation

When you press the **◀◀** or **▶▶** button during playback, playback will start from the beginning of the desired selection.

When it is pressed in the pause mode, the deck enters the pause mode at the beginning of the designated selection. Press the **⏸** or **▶** button to resume playback. For this operation, the start ID codes must be written on the tape.

For how to write the start ID, see page 28.

### To locate the selection ahead

Press the **▶▶** button. Each pressing advances the tape to the next selection in sequence.

**Example:** To designate five selections ahead, press the **▶▶** button five times.

|         |     |   |
|---------|-----|---|
| PGM NO. | AMS |   |
| 3       | 5   | The number of time you pressed <b>▶▶</b> is displayed |
| ↓       | ↓   |   |
| PGM NO. | AMS |   |
| 8       | 0   |   |

When the designated selection is located, playback resumes.

### To locate the previous selection

Press the **◀◀** button. Each pressing moves the tape to the previous selection in sequence.

**Example:** To designate three selection back (excluding the selection being played), press the **◀◀** button four times.

|         |     |   |
|---------|-----|---|
| PGM NO. | AMS |   |
| 6       | -3  | The number of time you pressed <b>◀◀</b> is displayed |
| ↓       | ↓   |   |
| PGM NO. | AMS |   |
| 3       | 0   |   |

When the designated selection is located, playback resumes. The display returns to the counter display.

When designating the selection being played back, "-0" appears.

**You can designate a selection by pressing the numeric buttons, instead of pressing the **◀◀** or **▶▶** button several times. In this case, press the **◀◀** or **▶▶** button after pressing the numeric buttons.**

## Music Scan

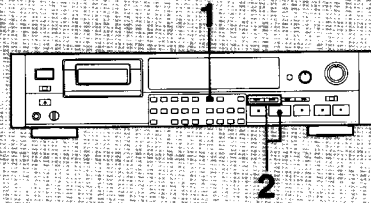

For this operation, the start ID codes must be written on the tape. For how to write the start ID codes, see page 28.

### 1 During the stop mode, press the MUSIC SCAN button.

The MUSIC SCAN indicator flashes and the designated scan time is indicated at the MARGIN display.

### 2 Press the **▶** (play) button.

The tape is rewound to the beginning, the first part of each selection (start ID position) is played back for the time you designated sequentially.

The **▶** and **START ID** indicators light during playback.

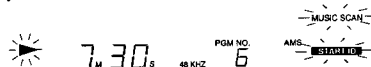

### When you press the **▶▶** button instead of the **▶** (play) button

The nearest start ID after the current position is detected, and, after playing back the first part of that selection for the time you designated, the next start ID in the forward direction is located.

This operation continues until the end of the tape.

### When you press the **◀◀** button instead of the **▶** (play) button

The nearest start ID before the current position is detected, and, after playing back the first part of that selection for the time you designated, the next start ID in the reverse direction is located.

This operation continues until the top of the tape.

### To designate the desired scan time

While the scan time is indicated at the MARGIN display in step 1, press the **◀◀** or **▶▶** button. You can designate the scan time up to 15 seconds in steps of a second. The scan time is 8 seconds if the scan time is not designated. (The designated time remains memorized even if you turn off the unit.)

# Various Playback Operations

## To listen to the beginning of a selection for more than the designated time

Press the ► (play) button while the selection you want to listen to is played back.

While pressing the ► button, the countdown at the MARGIN display stops, and the playback of that selection continues.

## To listen to an entire selection

Press the MUSIC SCAN button while the selection you want to listen to is played back.

The music scan function is released, and the playback of that selection continues.

When you press the MUSIC SCAN button during playback, the tape is rewound to the beginning, and then the first part of each selection (start ID position) is played back for the time you designated sequentially.

## Designating the Desired Selection

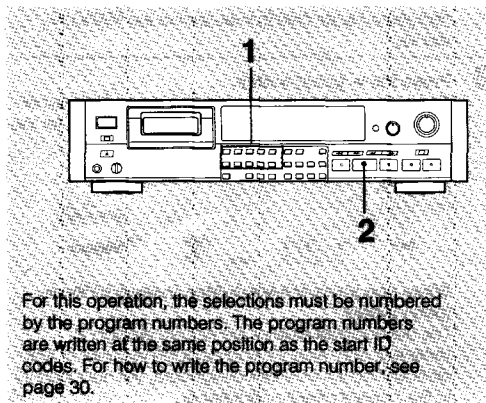

## 1 During the desired program number with the numeric button(s)\*.

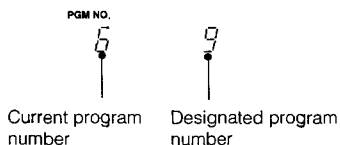

## 2 Press ► (play).

The designated selection is searched for at high speed and playback starts from the beginning of that selection.

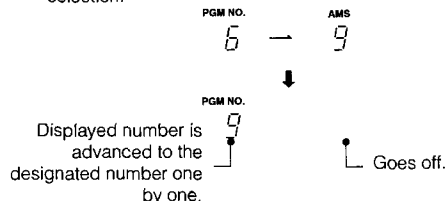

\* When you press the numeric button(s) during play-pause mode, the deck enters the pause mode at the beginning of the designated selection. Press the **II** PAUSE or ► button to resume playback.

## If an incorrect number is designated

Before pressing the ► button, press the CLEAR button. The displayed program number will be cleared.

Then designate the correct program number.

Once the ► button is pressed, it is impossible to cancel the designated selection.

## Skip Play

For this operation, the skip ID code(s) must be written on the tape.

## Press the SKIP PLAY button.

The SKIP PLAY indicator lights.

During playback, the tape skips to the next start ID position automatically when a skip ID is detected, and the playback resumes.



## To stop skip play

Press the SKIP PLAY button to turn off the SKIP PLAY indicator.

## Auto Play: Restarting Playback after Rewinding

While pressing ◀◀, press ▶▶.

The tape is rewound to the beginning, and playback starts automatically.

If the above operation is done immediately after the cassette is inserted, the auto play operation does not function. Press ▶▶ a few seconds after ◀◀ is pressed.

## Random Music Sensor (RMS) Operation

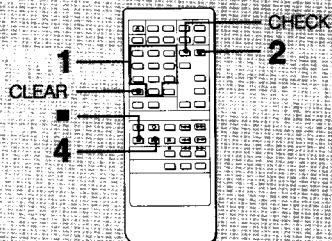

\*RMS = Random Music Sensor  
 The RMS function allows you to program the desired selections in the desired order.  
 For the operation, program numbers must be written on the tape.  
**This operation can be performed only with the remote commander.**

**To stop RMS play**  
 Press the ■ button.

**To check the programmed selections**  
 Press the CHECK button on the remote commander. Each time you press the CHECK button, the programmed selections appear in the designated order.

**To add a selection to the program**  
 Once the RMS play starts, you cannot add a selection. To add a selection, first stop the RMS play, and program new selection(s) by following the procedure described on the left column.

**To delete the selection you programmed last**  
 Press the CLEAR button.  
 However, when checking the programmed selection, the CLEAR button cannot be used.

**To cancel the entire program**  
 In the stop mode: Press the ■ button once.  
 In the RMS play mode: Press the ■ button twice.

- 1 Designate the desired selection by pressing the numeric button(s) during the stop mode.**  
 The selection numbers can be specified from 1 to 99.

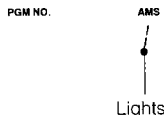

- 2 Press the ENTER button.**

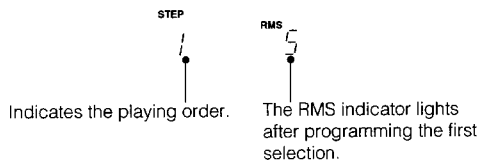

- 3 Repeat step 1 and 2.**  
 A maximum of 60 selections can be programmed.

- 4 Press the ► (play) button.**  
 The programmed selections are played back in the designated order.

# Timer Activated Operation

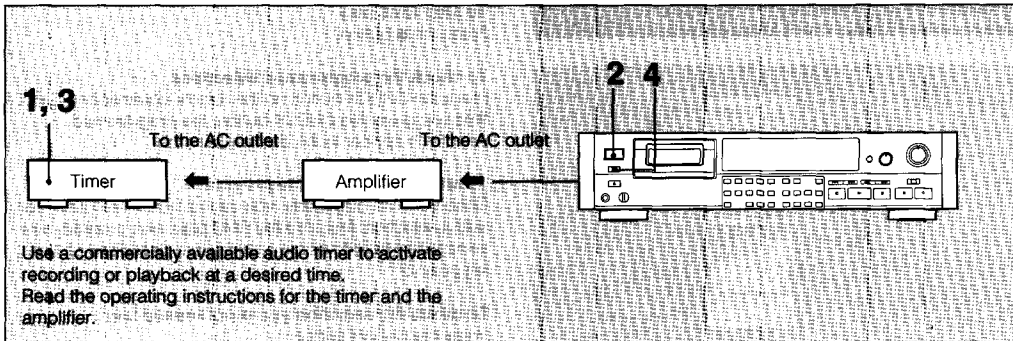

## Timer Activated Recording

- 1 Turn on the timer.**
- 2 Turn on the DAT deck, and prepare for recording.** (Follow steps of "Recording" on page 21)
- 3 Set the timer to the desired time.**  
Power to the amplifier and to the DAT deck is turned off. Leave the power switches of the equipment turned on.
- 4 Set TIMER to REC.**  
At the preset time, the power is supplied and recording starts after about 4 seconds. The AUTO indicator will be the same as the one before the power of the DAT deck is turned off. When the AUTO indicator lights, start IDs will be written during recording.

### When timer activated recording is finished

Be sure to set the TIMER switch to the OFF position.

### Precautions

- If the TIMER switch is left at the REC position, recording will start when the power is turned on the next time, and the tape contents will be erased.
- In timer recording (the TIMER switch is set to the REC position), the auto rewind function will not be activated even if the tape is fully taken up. The tape stops without being rewound so that recording will not be performed over the previously recorded material.
- Be sure to activate timer recording with the cassette inserted properly in the cassette compartment. With the cassette compartment lid opened, timer recording will not function.

## Timer Activated Playback

- 1 Turn on the timer.**
- 2 Turn on the DAT deck, and insert the cassette.**
- 3 Set the timer to the desired time.**  
Power to the amplifier and to the DAT deck is turned off. Leave the power switches of the equipment turned on.
- 4 Set the TIMER switch to the PLAY position.**  
At the preset time, the power is supplied and playback starts after about 4 seconds.

### When timer activated playback is finished

Normally set the TIMER switch to the OFF position.

If you want to start playback at the preset time every day automatically, leave the TIMER switch to the PLAY position.

### Note

The built-in clock can be used only for the date function. To record and playback at a desired time, use a commercially available timer.



**Cleaning the Cabinet**

Clean the cabinet, panels and controls with a soft cloth slightly moistened with a mild detergent solution. Do not use any type of abrasive and, scouring powder or solvent such as alcohol or benzene.

**Cleaning the Head**

Prolonged operation will cause contamination of the head. To make the best possible recording and playback, we recommend cleaning the head periodically, using the DT-10CL cleaning cassette (not supplied).

**How to use the cleaning cassette**

- 1 Insert the cleaning cassette as you insert a normal DAT cassette.
- 2 Press ►. Press ■ after about 10 seconds.
- 3 Remove the cleaning cassette without rewinding it.
- 4 Proceed with recording and playback with a normal DAT cassette and check the sound quality.

**Notes on the cleaning cassette**

- The cleaning cassette cannot be used for recording and playback.
- Do not clean the head with the cleaning cassette more than five times over a short period.  
Cleaning the head continuously for a too long period of time may cause wear to the head.
- Do not rewind the cleaning cassette each time you use it. When the cleaning cassette tape is taken up completely, rewind it to the beginning and re-use it. The cleaning cassette can be used two hundred times, with 10 seconds of cleaning each time.

# Guide to the Serial Copy Management System

This digital audio tape deck adopts the Serial Copy Management System. This system enables one generation of digital recording of prerecorded software via digital input/output. A summary of this system is as follows:

1

You can record a compact disc to a digital audio tape via digital input/output. But you cannot record the recorded tape to another via digital input/output.

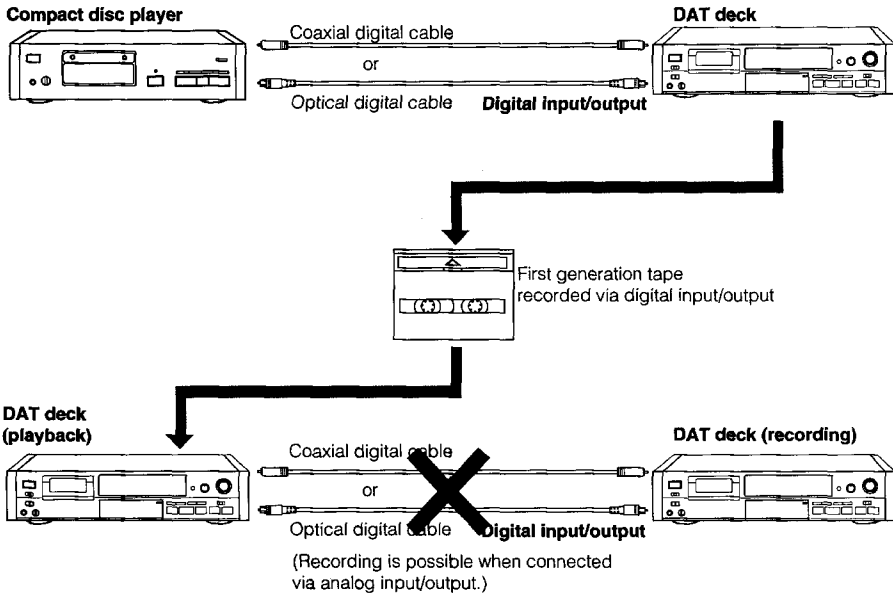

You can record a digital audio tape recorded via analog input/output to another via digital input/output. But, you cannot make a second generation tape via digital input/output.

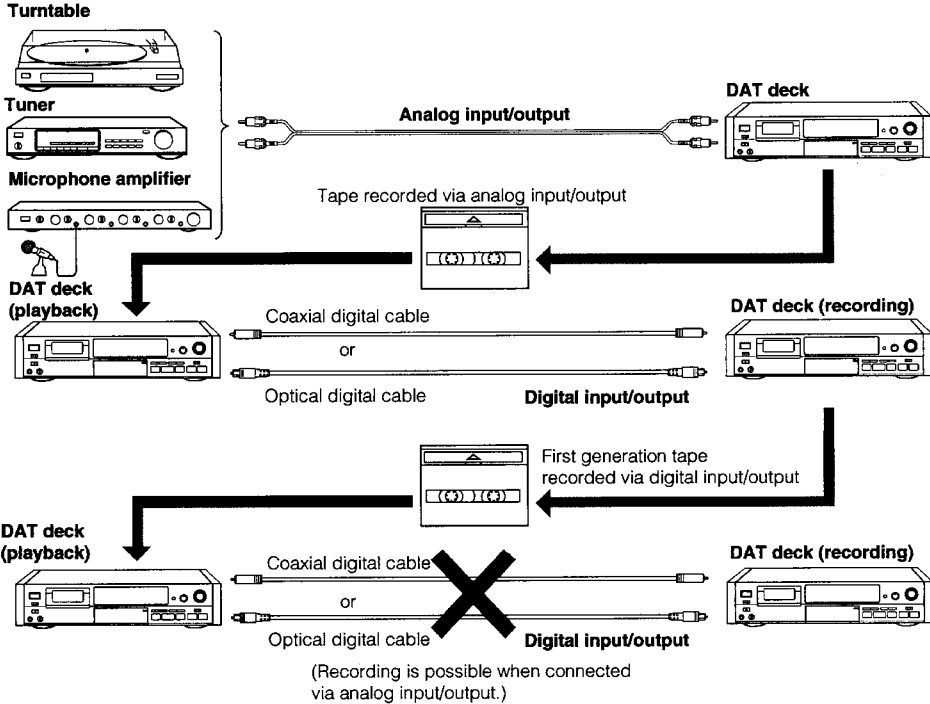

**Remarks**

There are no restrictions for generation when DAT decks are connected via analog input/output each other. These rules does not apply when you use a DAT deck which does not adopt the Serial Copy Management System.

# Troubleshooting

|   | Symptom  | Cause  | Remedy  |
|---|--|--|---|
| Basic operation   | The tape is ejected after being loaded.                    | The cassette is inserted incorrectly.  | Insert the cassette correctly. (page 19)  |
|   | The tape does not move.                                    | For 4 seconds after the power is turned on, the buttons do not function.   | Wait until the blinking of the <b>II</b> indicator goes off and then try again.   |
|   |  | The <b>II</b> PAUSE button is activated. (The <b>II</b> indicator lights.)   | Press the <b>II</b> PAUSE button to release pause.  |
|   |  | The tape is wound completely.  | Press the <b>◀◀</b> or <b>▶▶</b> button to rewind.  |
|   | The sound is not heard.                                    | Incorrect connections.   | Connect properly. (pages 15 and 16)   |
|   |  | Incorrect operation of the connected amplifier.  | Operate the amplifier as required by the deck operation. (Refer to the operating instructions of the amplifier.)  |
|   | Recording cannot be made.                                  | The safety tab of the cassette is open.  | Close the tab of the cassette. (page 19)  |
|   |  | Incorrect position of the INPUT selector.  | Set the INPUT selector correctly.<br>Set it to the DIGITAL position to record sound from the equipment connected to the COAXIAL IN or OPTICAL IN jacks.<br>Set it to the ANALOG position to record sound from the equipment connected to the LINE IN jacks. |
|   |  | The digital copy prohibit signal exists in the source signal input to the digital input jack.                                | Connect the source equipment to the LINE IN jacks.  |
|   | The sound is not heard from the recorded tape.             | When recording analog input signals, the recording level is turned down completely. (When recording the analog input signal) | Adjust the recording level by using the REC LEVEL controls. (page 23)   |
|   | The CAUTION indicator lights, and no button does function. | Moisture condenses inside the unit.  | Leave the unit turned on for about an hour. (page 4)  |
|   |  | Defective or damaged cassette is inserted.   | Remove the cassette.  |
| The cassette is removed forcibly from the cassette compartment. |  | Turn off the unit and then turn on again.  |   |

|                                 | Symptom  | Cause   | Remedy  |
|---------------------------------|--|---|---|
| Sub code operation              | <b>Start ID cannot be written during recording.</b>                          | A new start ID cannot be written within 9 seconds (18 seconds in the long-play mode) from the end of another start ID.                                | Leave at least 9 seconds (18 seconds in the long-play mode) from the end of another start ID.   |
|                                 | <b>Search function does not operate during playback.</b>                     | The start ID is not written correctly.  | Erase it (page 29), and then write it again.  |
|                                 |  | The portion between the end of a start ID and the beginning of the following start ID is less than 9 seconds (18 seconds in the long-play mode) long. | When writing the start IDs manually, write so that the intervals between them are more than 9 seconds (18 seconds in the long-play mode.)                               |
|                                 |  | The selected program number does not exist on the tape.   | Use the RENUMBER button to re-arrange the program numbers. (page 31)  |
|                                 |  | The program numbers are out of order.   |   |
|                                 | <b>Search function operates suddenly during playback.</b>                    | The skip play function is operating. (The SKIP PLAY indicator lights in the display window.)  | Turn off the indicator by pressing SKIP PLAY.   |
|                                 |  | The repeat play function is operating.  | Turn off the indicator by pressing REPEAT 1/ALL.  |
|                                 | <b>Search function stops.</b>  | There is a blank section between selections. (The sampling frequency indicator blinks on the display window.)   | Use the end search function (page 24) when recording so that no blank is created.   |
|                                 | <b>The tape operation buttons do not operate while writing the start ID.</b> | While writing the start ID (9 seconds or 18 seconds), none of the buttons except the ■ button are operative.  | Operate after the start ID is written.  |
|                                 | <b>The absolute time codes cannot be written.</b>                            | Recording was started from the blank section.   | Rewind the tape to the beginning, or locate the very last point of the previous recording, using the end search function (page 24), and start recording from the point. |
|                                 | <b>End ID cannot be written during playback.</b>                             | The portion where you want to write the end ID is blank.  | Set the deck in the record-pause mode by pressing ●REC, then write the end ID.  |
|                                 | <b>Renumbering function does not operate.</b>                                | The portion between the end of a start ID and the beginning of the following start ID is less than 9 seconds (18 seconds in the long-play mode) long. | When writing the start IDs manually, write so that the intervals between them are more than 9 seconds (18 seconds in the long-play mode).                               |
|                                 | <b>Start ID cannot be erased.</b>  |   |   |
|                                 | <b>Skip ID cannot be erased.</b>   | Two skip IDs are written continuously.  | When writing the skip IDs, write so that the intervals between them are more than 1 second (2 seconds in the long-play mode).   |
| <b>End ID cannot be erased.</b> | The end ID is written at the beginning of the tape.                          | Start recording from the beginning of the tape.   |   |
|                                 | The end ID is written immediately after a start ID.                          | First erase the start ID.   |   |

# Troubleshooting

|        | Symptom   | Cause   | Remedy  |
|--------|---|---|---|
| Others | <b>Tape transport noise seems excessively loud in rewind or fastforward mode.</b>                             | This situation depends upon the cassette being used and is not a problem. | —   |
|        | <b>The tape stops running suddenly.</b>   | A defective or damaged cassette has been inserted.                        | Press the <b>▲OPEN/CLOSE</b> button to change the tape.                           |
|        | <b>Unbalanced left and right volume.</b>  | Incorrect adjustment of the recording balance.                            | Adjust the recording balance correctly by using the REC LEVEL controls. (page 23) |
|        | <b>Increase of noise or deterioration of sound quality.</b>   | Contamination of the head.  | Clean the head, using the cleaning tape.  |
|        | <b>The clock for the date function does not operate once the power is off.</b>                                | The battery built in this unit is weak.                                   | Ask the Sony dealer to change the battery.  |
|        | <b>After pressing <b>◀◀ / ▶▶</b> or <b>◀◀ / ▶▶</b>, the tape stops for a moment, and then starts running.</b> | This is not a problem.  | —   |

# Specifications

|                  |  |
|------------------|--|
| Tape             | Digital audio tape   |
| Recording head   | Rotary head  |
| Recording time   | Standard: 120 minutes.<br>Long-play mode: 240 minutes<br>(with DT-120) |
| Tape speed       | Standard: 8.15 mm/s.<br>Long play mode: 4.075 mm/s                     |
| Drum rotation    | Standard: 2,000 rpm,<br>Long-play mode: 1,000 rpm                      |
| Error correction | Double Read Solomon code   |

## Tape

|                               |   |
|-------------------------------|---|
| Track pitch                   | 13.6 $\mu$ m (20.4 $\mu$ m)                                     |
| Sampling frequency            | 48 kHz, 44.1 kHz, 32 kHz  |
| Modulation system             | 8-10 Modulation   |
| Transfer rate                 | 2.46 Mbit/sec.  |
| Number of channel             | 2 channels, stereo  |
| D/A conversion (Quantization) | Standard: 16-bit linear<br>Long-play mode: 12-bit<br>non-linear |

|                    |  |
|--------------------|--|
| Frequency response | Standard: 2-22,000 Hz<br>( $\pm 0.5$ dB)<br>Long-play mode: 2-14,500 Hz<br>( $\pm 0.5$ dB) |
|--------------------|--|

|                       |   |
|-----------------------|---|
| Signal to noise ratio | Standard: more than 92 dB<br>Long-play mode: more than<br>92 dB |
|-----------------------|---|

|               |   |
|---------------|---|
| Dynamic range | Standard: more than 92 dB<br>Long-play mode: more than<br>92 dB |
|---------------|---|

|                           |  |
|---------------------------|--|
| Total harmonic distortion | Standard: less than 0.0045%<br>(1 kHz)<br>Long-play mode: less than<br>0.08% (1 kHz) |
|---------------------------|--|

|                 |  |
|-----------------|--|
| Wow and flutter | Below measurable limit<br>( $\pm 0.001\%$ W. PEAK) |
|-----------------|--|

## Input

|                   | Jack type    | Impedance | Rated input level    |
|-------------------|--------------|-----------|----------------------|
| <b>LINE IN</b>    | phono jack   | 47 kohms  | -4 dBs               |
| <b>DIGITAL IN</b> | phono jack   | 75 ohms   | 0.5 Vp-p, $\pm 20\%$ |
| <b>DIGITAL IN</b> | optical jack | —         | —                    |

## Output

|                    | Jack type            | Impedance | Rated output           | Load impedance        |
|--------------------|----------------------|-----------|------------------------|-----------------------|
| <b>LINE OUT</b>    | phono jack           | 470 ohms  | -4 dBs                 | More than<br>10 kohms |
| <b>PHONES</b>      | stereo<br>phone jack | 220 ohms  | 0.6 mW                 | 32 ohms               |
| <b>DIGITAL OUT</b> | phono jack           | 75 ohms   | 0.5 Vp-p<br>$\pm 20\%$ | —                     |

DIGITAL OUT (optical jack): wavelength 660 nm

## General

|                    |   |
|--------------------|---|
| Power requirements | 120 V AC, 60 Hz   |
| Power consumption  | 32 W  |
| Dimensions         | Approx. 470 x 110 x 350 mm<br>(w/h/d)<br>(18 <sup>5</sup> / <sub>8</sub> x 4 <sup>3</sup> / <sub>8</sub> x 13 <sup>7</sup> / <sub>8</sub> inches) |
| Weight             | Approx. 6.6 kg (14 lb 10 oz)  |

## Remote commander (supplied)

|                       |   |
|-----------------------|---|
| Remote control system | Infrared control  |
| Power requirements    | 3V DC, with two size AA (R6)<br>batteries   |
| Dimensions            | Approx. 63 x 19 x 175 mm<br>(w/h/d)<br>(2 <sup>1</sup> / <sub>2</sub> x <sup>3</sup> / <sub>4</sub> x 7 inches) |
| Weight                | Approx. 130 g (4 oz) incl.<br>batteries.  |

## Supplied accessories

Sony batteries SUM-3(NS) (2)  
Audio connecting cords (2 phono plugs - 2 phono plugs,  
stereo for line inputs and outputs) (2)  
Screws (4)

Design and specifications are subject to change without  
notice.

## Accessories not supplied

|                   |  |
|-------------------|--|
| Optical cable     | POC-15, etc.   |
| Connecting cord   | RK-C77<br>(2 phono plugs - 2 phono<br>plugs: connectors plated<br>with gold, high quality litz<br>line cord)<br>VMC-1ES, 3ES, etc. (phono<br>plug - phono plug): for<br>digital connection |
| Cleaning cassette | DT-10CL  |