

# ***XTRONS***

## **USER OPERATION MANUAL**



D302

# TABLE OF CONTENTS

<b>Safety Information.....</b>	<b>1</b>
<b>Park Wire/Brake Wire.....</b>	<b>2</b>
<b>Installation.....</b>	<b>3-4</b>
<b>Wiring Diagram.....</b>	<b>5</b>
<b>Playable Disc, DVD Care, MP3.....</b>	<b>6</b>
<b>Maintenance.....</b>	<b>6-7</b>
<b>Replacing Remote Control Battery .....</b>	<b>7</b>
<b>Remote Control.....</b>	<b>8</b>
<b>Remote Control Functions.....</b>	<b>8-9</b>
<b>Front Panel.....</b>	<b>10</b>
<b>Front Panel Functions.....</b>	<b>11</b>
<b>Basic Setup.....</b>	<b>12-13</b>
<b>Radio Mode.....</b>	<b>14</b>
<b>Music/MP3 Mode.....</b>	<b>14</b>
<b>DVD Mode.....</b>	<b>15</b>
<b>USB Mode.....</b>	<b>16</b>
<b>Auxiliary Mode (Input).....</b>	<b>16</b>
<b>Trouble Shooting.....</b>	<b>17-18</b>
<b>Specification.....</b>	<b>19</b>
<b>Accessories.....</b>	<b>20</b>

## **Safety Information**

Please read this manual thoroughly and keep in your vehicle for easy future reference.

We highly recommend that you find a licensed professional installer for the installation of this product, it is illegal to watch DVD player while driving.

**CAUTION:** This unit is a class 1 Laser Product. To prevent direct exposure to Laser system, DO NOT OPEN the unit. The Laser Beam may hurt or damage your eyes. If the unit requires adjustments, please contact Sumas Media.

### **USE THIS PRODUCT SAFELY**

Make sure you fully understand the following safety information:

#### **When Driving**

Keep the unit at an appropriate sound level. Driving with the sound at a level that prevents you from hearing the sounds outside and around the car may cause an accident.

#### **When cleaning your interior**

Do not expose the product to any type of liquid or excessive moisture. This could cause short circuit, fire or other severe damage to the unit or your vehicle.

#### **When Parked**

Parking in direct sunlight, especially in the summer time can produce very high temperature inside your vehicle. This may cause the unit to not work properly. Let the interior of your car to cool down before turning on the unit. Note: Do not use or store player in dusty, high temperature or high humidity environments.

### **Park wire/Brake wire**

Park wire is to be connected to your parking brake (Hand brake) or your unit will not function, also for your safety; when car is operated, it will restrict you to play/watch DVD while driving, display shows: "Safety off, do not play DVD"

But some make or model of automobiles don't have a "Parking brake" wire, if you have problems to connect to your brake, you can also ground this wire to your car's chassis, unit will play; but restriction will be disabled, so please do not watch your unit when driving!

### **Replacing the Fuse**

When replacing the fuse, be sure to use one matching the amperage rating stated on the original fuse.



**WARNING!**

**NEVER** replace any Fuse with higher amperage than the original. This may cause damage to your unit and/or your vehicle's electrical wiring.

## Installation

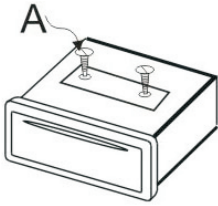

**Note: Remove the protection screws (A) before installing and operation the unit.**

**Please find the front panel inside carry caddy. Reinstall panel by placing as flipped down position, insert panel left side into front adaptor first, then gently click right side into place. When completed correctly panel should be flip up in place.**

**To remove the panel, gently pull out the right side first after flipped down.**

- This unit is designed for 12V DC, (connecting to other than 12V unit will be damage) negative ground operation system only.
- When replacing a fuse, be sure to match the amperage as the original fuse. Using the wrong fuse may cause your unit not to function or even electrical shortage
- The negative battery terminal must be disconnected before making connections, which can prevent damaging the unit due to short circuit.
- Be sure to connect the color coded leads correctly according to the wiring diagram. Incorrect connections may cause damage or malfunction or even damage the vehicle's electrical system.
- Be sure to connect the speaker (-) leads to the speaker (-) terminal, and the speaker (+) leads to the speaker (+) speaker terminal and so on. Never cross connect the left / right channel speaker cables or to the vehicle body/frame.
- Do not block the unit's vents or heat sink. Blocking can cause heat to build up inside and may damage your unit.

- After the completion of the installation. Reconnect negative cable of vehicle to the (-) battery terminal, and then press the RESET in the front panel with the push pin to set the unit to initial status. Please refer below. ( see picture below)

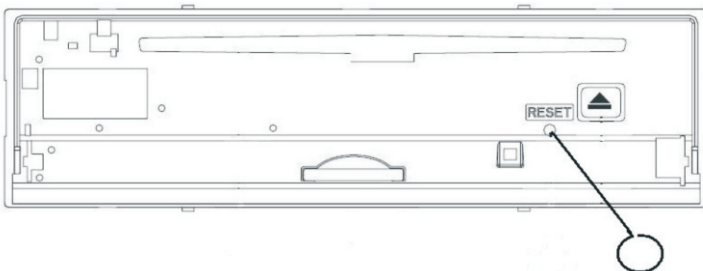
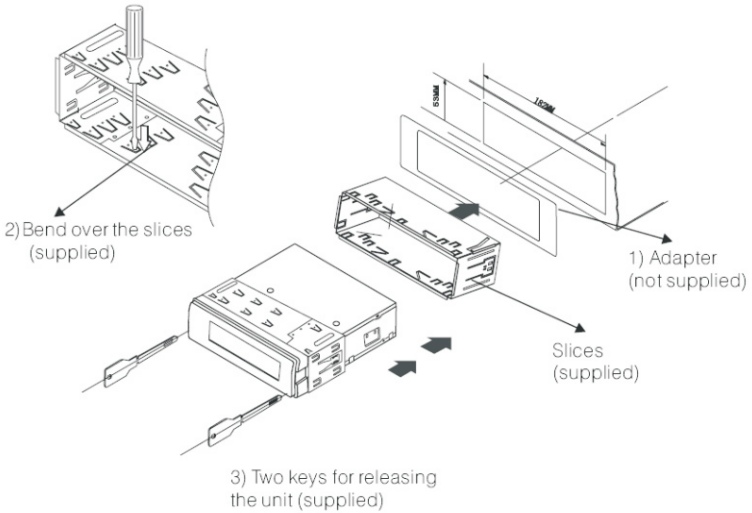

## Unit Installation & Removal

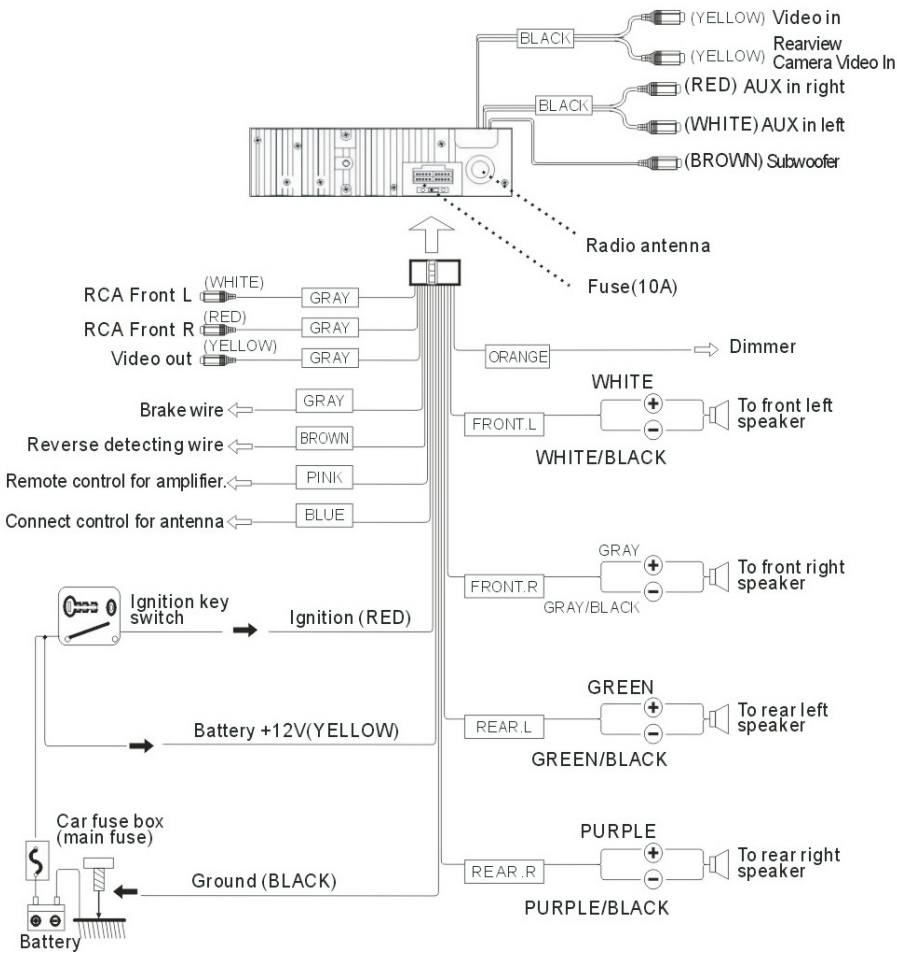

# Maintenance

## Playable discs

DVD, Video CD and CD discs that display the logos shown below can be played back on this unit.



DVD video disc region numbers:

(This unit is for region one only, it will not play other region's DVD)

**If you encounter region problems, please call toll free service number on back page, we will help you resolve it.**

## DVD Care

If you use an irregular disc it may jam the DVD player or not play, for this reason only use round discs

Be sure to check all discs for cracks and scratches before playing, discs in those conditions will not play properly. Also, be sure to avoid touching the recorded (plain) side of the disk

Avoid scratching the disc. Store CDs in case when not in use

Keep discs out of direct sunlight (it will cause them to warp and crack) to clean the CDs, wipe with a soft cloth from the inside of the disc outward

## MP3

MP3 files on CD-ROM, CD-R and CD-RW are compatible with this unit.

Discs compatible with ISO9660 level one and two or with ROMEO and JULIET, recorded discs with the multi sections can also be played. MP3 files are incompatible with the transportation of read-in files.

The max character width of the folder name is 32. If the file is recorded through ROMEO and JULIET system, only the former 32 characters are displayed. While playing discs with MP3 and CD-DA, such as CD EXTRA and MIXED MODE CD the system can only switch between MP3 and CD-DA. The selected folder sequence of playing and other operations will be the sequence to write in the software. So the anticipated sequence of playing should not conflict with the actual playing sequence. However, there is, indeed some software that play sequence is allowed to be set. The file is compatible with Id3 label version 1.0 and 1.1, so as to



display the music titles and authors. The enhancing function is valid only when playing MP3 in 32, 44.1 and 48 KHz sample frequencies 16,22,05,24, 32, 44.1 KHz can be played. The tone of MP3s file can usually be bettered when the bit rate is increased. This machine can play recordings between 8KBPS and 320 KBPS. However, in order to enjoy a good tone, we recommend discs over 128KBPS.

### !!!!!!IMPORTANT!!!!!!

While naming an MP3 file, add relevant extending name “.mp3”

This machine will play files with .mp3 as MP3; do not use this extending name on non mp3 files to avoid noises and other problems.

### MP4

Due to new **DivX** version restriction on decoding, this unit will play most of the **DivX** format but some of the newer version will not.

It can also play most of the **.avi** files with MPEG 4 codec.

### Replacing Remote Control Battery

\* When the remote control operation range becomes an issue or none functional at all. Replace the battery with a new button cell. Make sure to purchase the same size battery.

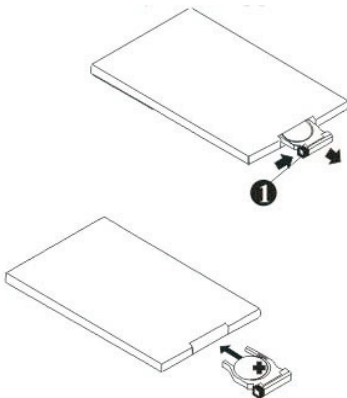

1. Pull out the Battery Holder while pressing the stopper.

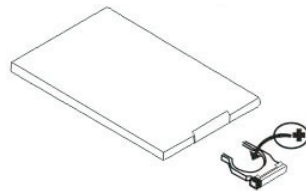

2. Put the button-type battery (+) mark upward into the battery holder.

# Remote Control

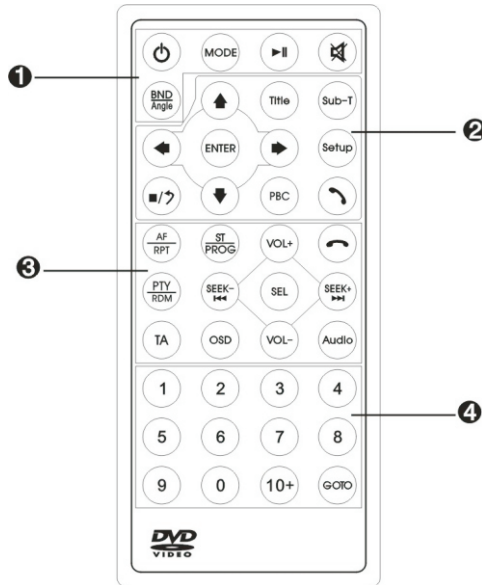

## REMOTE CONTROL FUNCTIONS

- ❶ [ ] **Button:** Unit Power  
 [ **MODE** ] : Into the main menu mode  
 [ ] **Button:** Pause or play  
 [ ] **Button:** Sound on/off  
 [ **BND/Angle** ] **Button:** FM/AM switch / Change shot angle
- ❷ [ ] **Button:** Up/down/left/right button  
 [ **ENTER** ] **Button:** Play/Confirm  
 [ **Title** ] **Button:** Open title Menu of DVD  
 [ **Sub-T** ] **Button:** Change subtitle language  
 [ **Setup** ] **Button:** Open setup menu  
 [ ] **Button:** Stop/Return playback  
 [ **PBC** ] **Button:** No function  
 [ ] **Button:** Answering the Telephone

- ③ **[AF/RPT] Button:** No function /Repeat playback mode
- [ST/PROG] Button:** Stereo switch/No function
- [VOL+/VOL-] Button:** Decrease or increase volume
- [ ] Button:** Hang up
- [PTY/RDM]Button:** No function/Random playback
- [SEEK-/ I◀◀] Button:** Backward previous  
Search /backward previous chapter
- [SEEK+/ ▶▶I]Button:** Backward forward  
Next search /Forward next chapter
- [SEL] Button:** Into system setting menu
- [TA]Button:** No function
- [OSD] Button:** Into DVD operation setting menu
- [Audio] Button:** Change audio channel
  
- ④ **[0~9] Button:** 0~9 numeric keys
- [10+] Button:** over 10 numeric key
- [GOTO] Button:** No function

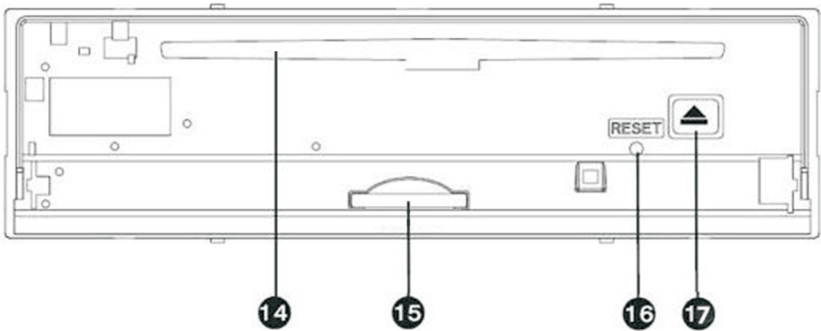
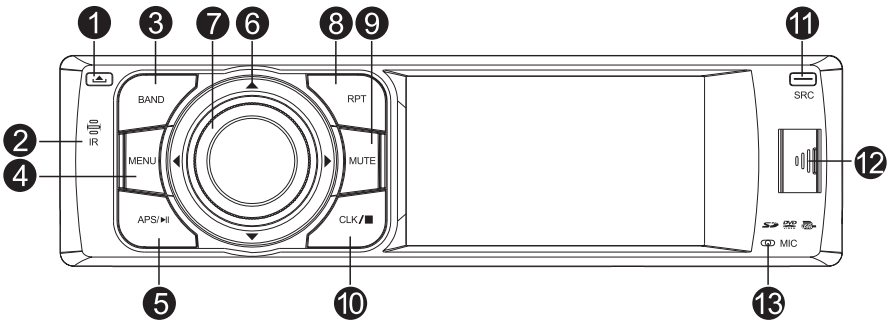

## Front Panel



1. Release Panel Button
2. IR
3. Band Select button
4. Menu Button
5. APS Button
6. Four Way Directional button
7. Volume Knob
8. RPT

9. Mute Button
10. CLK
11. SRC
12. USB Port
13. MIC
14. Disc Slot
15. SD Slot
16. Reset Button
17. Eject DISC Button

## FRONT PANEL FUNCTIONS

1.  – Front panel release button
2. **IR** - Remote control signal receive windows
3. **Band** – To toggle change between FM1/FM2/FM3/AM1/AM2
4. **Menu** – System settings
5. **APS/▶|**– Reception Scan
6. **Four directional buttons** – To change setting using up/down/left/right
7. **Volume Knob** – For adjusting volume levels
8. **RPT** – Repeat on/off
9. **Mute**– Mute
10. **CLK/■**– Clock display
11. **Source/Power** – To turn the unit on and toggle between Modes DVD/CD/Tuner/USB/SD/AUX/Bluetooth modes
12. **USB Port** – For inserting supported USB device
13. **MIC** – (microphone) Use when on Bluetooth mode
14. **Disc Slot** – For inserting discs
15. **SD/MMC Slot** – Memory Card Slot
16. **Reset** – To reset all setting to factory default
17.  – To eject inserted discs

# Basic Setup

## Powering the unit ON/OFF

- Press the **Source/Power** button once to turn the unit on. Press and hold to turn off.

**Note:** When using the remote, just press **"PWR"** power button once to turn unit on/off.

## Switching Modes

- Press the **Source/Power** Button on the unit repeatedly to cycle through the **Modes**. When on the main screen, simply touch the desired icon. (see below)

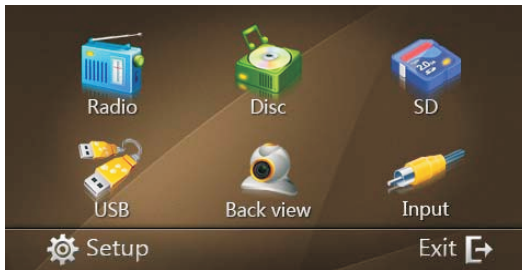



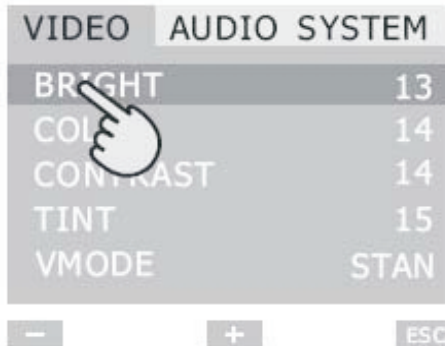

**Main Screen**

## Video Setting

- To change settings, press **MENU** button on the panel or **Setup** on the remote control. Scroll down or touch the option you want to change directly on the screen, press **+** **-** to change settings. Play with these options to get the desired setting. Touch **VMODE** then **+** **-** to cycle through preprogrammed video settings.







## Audio Settings

- To change settings, press the **Menu** or **Setup** on the remote control, then touch "AUDIO" tab on the screen or press  on the remote. Touch the screen on the desired option, then press   to change the settings. (Setup between 0-14) Play with these options to get the desired audio output. For the preset equalizer settings, simply touch **EQ** then   to cycle through **NORM, ROCK, POP** and **CLAS**.



## System Mode Settings

- To change settings, press the **Menu** on the screen or **Setup** on the remote control then touch "System" on the screen or press  twice on the remote. Touch the screen on the desired option then press   to turn settings on/off. Play with these options to get the desired setting. To change/set time touch or scroll down to **TIME ADJ**, then touch the hour **00:00** section and press   to adjust time, repeat steps to change minutes.

Note: Time is set to military time only, (24hr time mode).

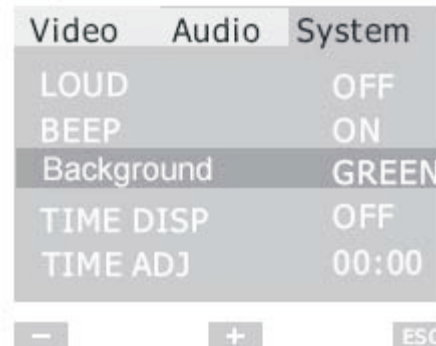

\*Background function only on radio mode, which allow you to change/choice from four different color/graphics.

## Basic Operation

### Radio Mode

- Press **Power/SRC** button on the unit, and then touch the "**Radio**" icon the screen.
- **Band Select:** Touch "**BAND**" to select from **FM1, FM2, FM3, AM1 or AM2**.
- **Manual Tuning:** Touch **◀◀ or ▶▶** repeatedly to locate the desired frequency.
- **Automatic Tuning:** Touch and hold **◀◀ or ▶▶** for 3 seconds to search available frequencies.
- **Storing Radio Stations:** To store stations to the unit, locate the desired station using **◀◀ or ▶▶**, then press and hold the desired number on the remote control (from 1 to 6). Unit will beep once set. Repeat steps for the rest of the numbers and Band section.
- **Automatic Radio Station Storing:** To randomly store available frequencies, Simply touch and hold the "**APS**" button for about 2 seconds then release.

\***NOTE:** This unit can store up to 18 FM Stations (FM1=6, FM2=6, FM3=6) and up to 12 AM Stations (AM1=6 AM2=6).

### Music/MP3 CD Mode



- **Inserting a CD:** Press the  "**Release**" to open front panel, then insert a Music or MP3 Disc into the disc slot with label facing up. Then push front panel back into place. Unit should automatically switch to "**DISC**" mode. The unit will start playing the first track on the CD.
- **Track Select:** To skip forward or backwards through the tracks simply press **◀◀ or ▶▶**. Or touch screen and submenu will appear with play control functions. (See Fig. A)
- **Random Playing:** Press "**Band/RDM**" button once to play track in random order, press again to turn random off.
- **Repeat Play:** Press "**ST/RPT**" button to repeat what's currently playing, press again to turn off repeat play. For MP3 playing to repeat a whole folder press "**RPT**" 2x and 3x to turn off random.





Fig. A

### DVD Mode

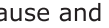
- **Inserting a DVD:** Press the  "Release" button to open front panel to insert DVD or VCD Disc into the disc slot. (Make sure label is facing up), Flip the panel back into place. Unit should automatically switch to "DVD" mode. The unit will start playing the content of the DVD.
- To skip or find chapters press  on the unit or touch the screen to bring up submenu controls. (See Fig. A)
- Press  to pause and play movie.
- For "Subtitle". Simply press "SUB-T" on the remote to turn on/off.
- For "Repeat playing" press "RPT" once to repeat "Chapter" (current track), twice for "Title" (the entire movie), and three times to end repeat play.

## Basic Operation cont.

### USB/SD/MMC Mode

- **Inserting a USB** media device: Remove the protective cover of the USB input, plug in device into the unit. (Unit will automatically switch to **USB** mode). If audio files are present, then the first track will play automatically. To view pictures press the ► right arrow on the remote then ◀ left until the  is highlighted on the bottom of the screen, then press "Enter" then press ▲ up arrow and then "Enter" to play the first file. For playing Videos repeat above steps but highlight ► on the bottom of the screen.
- **Inserting SD/MMC** memory card: Remove front panel (see page 6). Then insert the memory into the slot all the way in until the unit grabs the card, reinstall front panel back into the unit. Turn unit back on, and select the SD mode from the main menu.  
When removing memory card, first removed the panel, then lightly/quickly push the memory card in to eject the card, then pull card out to remove.

\*Note: Random play is only available on pictures and audio files. Repeat play is available on all.

### AUX MODE (INPUT)

- To use "**AUX**" (**auxiliary**) mode: Plug RCA audio/video cables into the "**AUX input**" on the back of the unit to your device. Press the **SOURCE** button repeatedly to select auxiliary mode or go to the main screen and press "**Input**" icon.

\*Note: You can only control your device functions through the inserted device.

## Trouble Shooting

<b>Problem</b>	<b>Reason/Cause</b>	<b>Conclusion/Solution</b>
Will not turn on.	Incorrect wiring connections.	Check all wires are properly connected. Please refer to the wiring diagram
Remote control not functional.	Insufficient battery power. Remote sensor blocked.	Replace battery. (page 3)/ Make sure there is nothing blocking the remote control sensor.
DVD/CD will not play, or play properly.	Disk is dirty or scratched. Disc isn't compatible with unit. Content of the disc is not supported.	Clean the disc with a soft cloth. Check disc compatibility. (see page 3) Try another disc that is compatible.
Some DVD movies will not play. Displaying message on the screen.	Check and make sure the disc is inserted properly. Disc content is not supported.	Eject disc and make sure it is properly inserted (label facing up). Make sure the DVD is Region 1. This unit ONLY plays Region 1 DVD's.
No Sound/Volume or will not increase.	Incorrect wiring connection. Unit is on mute, playing frame by frame, fast forwarding or rewinding is turned on.	Check all the speaker wires are connected properly with the unit and the speakers themselves. Un-Mute the unit.
LCD does not display picture, or say "picture off for safety." on screen.	"PARK" wire is not connected properly to the hand brake wiring. Car is moving. Parking brake is not applied. ("Picture off for safety"); wiring not properly connected	Pictures will only appear when parking brake is applied for safety. Check wiring and make sure everything is properly connected. Consult a professional installer, Make sure "PARK" wire is properly connected to the park brake or ground. (see page 1 )

Certain speaker will not output sound.	Fader/Balance settings activated. Speaker(s) might be damage.	Make sure all the connections linking the speakers are properly connected. Make sure all the speakers work properly.
When the unit powers on, there is a loud noise.	The unit is reading inserted disc. The disc drive is resetting to its normal position.	Normal function.
USB flash drive or SD card will not read.	Loose or dirty connection. Or no connecting properly  Over capacity or not compatible	Check/clean connections. Make sure the USB flash/SD card drive is securely inserted into USB/SD port. Unit can only read up to 2- 4GB, depending on the size of the date
No subtitle. Subtitle in the wrong language.	Subtitle not activated. / DVD movie does not have subtitle in the desired language.	Press "SUB-T" on the remote to switch on. Make sure DVD movie has subtitle with the desired language.
Videos/Pictures are obscure or blurred.	Video/picture resolutions are low.	Make sure the videos/pictures have the appropriate resolution for a 3" screen.
Does not play Music files.	Files are not supported.	Check that the files are supported. (see page 3) Make sure the files are converted correctly.
MP4 video will not play.	Require compatible MP4 format/codec.	See page 3 (MP4).
Can't set "BASS" or "TREBLE" on set up	"EQ" is not on " NORM"	When "EQ" is on other than " NORM" no set up can be change, set "EQ" to " NORMAL"

# Specifications

## General

- Power Requirements ..... 12 V DC
- Load Impedance ..... 4Ω-8Ω
- Tone Control ..... ±8dB (Bass 100Hz, Treble 10KHz)
- Dimensions ..... Approx. 7.36"D x 6.69"W x 2"H
- Mounting Dimensions ..... 7.50"D x 6.75"W x 2.25"H
- Weight ..... 4.25lbs

## DVD Deck Section

- Disc Play ..... MP4, DVD, VCD 1.0/1.1/2.0/3.0, MP3, CD, CD-R, CD-RW, PICTURE-CD
- Video System ..... Auto/NTSC/AUTO
- Mounting Angle ..... 0° to +/- 30°

## Video Section

- Video System ..... 16:9 Wide screen
- Video Output Level ..... 1.0Vp-p 75 ohms
- Horizontal Resolution ..... 500 lines

## Audio Section

- Maximum Output Level ..... 2Vrms (+/-3dB)
- Frequency Response ..... 20 to 20KHz
- Signal-to-Noise Ratio ..... 85dB
- Separation ..... 80dB

## AM Tuner Section

- Frequency Range ..... 530-1710 (USA)
- IF Range ..... 450 KHz
- Usable Sensitivity (-20dB) ..... 25dB

## FM Tuner Section

- Tuning Range ..... 87.5 – 107.9
- IF Range ..... 10.7 MHz
- Usable Sensitivity (-30dB) ..... 15dB
- Signal-to-Noise Ratio ..... 60dB
- Stereo Separation ..... 30dB (1KHz)
- Frequency Response ..... 30~15000Hz

# Accessories

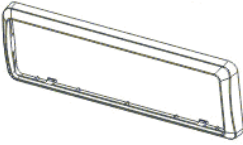

Faceplate Frame

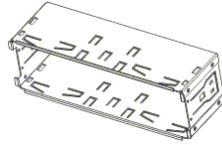

Dash Insert Casing



Screws



Extractors



Wiring Harness



Faceplate Caddy

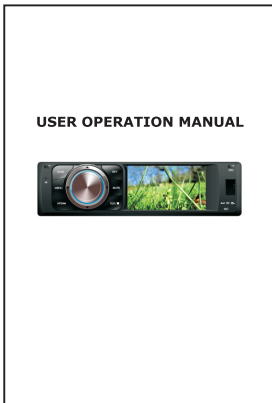

Manual



Remote Control

