

Wireless Stereo Headset
MDR-ZX220BT



Use this manual if you encounter any problems, or have any questions.

Getting started

BLUETOOTH connection

- What you can do with the BLUETOOTH function >
- How to make a wireless connection to BLUETOOTH devices >

Supplied accessories

- Checking the package contents >
- About the supplied manuals >

Features

- What you can do with the headset >

Parts and controls

Location and function of parts



About the indicator



Charging the headset

System requirements for battery charge using USB



Charging the headset



Available operating time



Checking the remaining battery charge



Voice guidance

About voice guidance



Making connections

One-touch connection (NFC) compatible Android devices

One-touch connection (NFC) with a smartphone (Android 4.1 or later)



One-touch connection (NFC) with a smartphone (Android 2.3.3 or later, and less than Android 4.1)



Disconnecting the smartphone by one touch (NFC)



Switching the device by one touch (NFC)



Android devices not compatible with one-touch connection (NFC)

Pairing and connecting with an Android smartphone



Connecting to a paired Android smartphone



iPhone (iOS devices)

Pairing and connecting with an iPhone



Connecting to a paired iPhone



Computers

Pairing and connecting with a computer (Windows 10)



Pairing and connecting with a computer (Windows 8/Windows 8.1)



Pairing and connecting with a computer (Windows 7)



Pairing and connecting with a computer (Windows Vista)



Connecting to a paired computer (Windows 10)



Connecting to a paired computer (Windows 8/Windows 8.1)



Connecting to a paired computer (Windows 7)



Connecting to a paired computer (Windows Vista)



Other BLUETOOTH devices

Pairing and connecting with other BLUETOOTH devices



Connecting to a paired BLUETOOTH device



Multi point connection

Connecting the headset to both a music player and a smartphone or mobile phone



Connecting the headset to 2 Android smartphones



Connecting the headset to an Android smartphone and an iPhone



Listening to music

Listening to music via a BLUETOOTH connection

Listening to music from a device connected via BLUETOOTH



Controlling the audio device (BLUETOOTH connection)



Disconnecting BLUETOOTH connection (after use)



Supported codecs

Supported codecs



Making phone calls

Making phone calls

Receiving a call



Making a call



Functions for a phone call



Disconnecting BLUETOOTH connection (after use)



Important information

Precautions

Precautions



What is BLUETOOTH wireless technology?



Trademarks

Trademarks



Support website

Customer support websites



Troubleshooting

Troubleshooting

What can I do to solve a problem?



Power

The headset is not turned on.



Charging

Charging cannot be done.



Charging time is too long.



The headset cannot be recognized by a computer.



The remaining battery charge of the headset is not displayed on the screen of an iPhone, iPad, or iPod touch.



Sound

No sound



Low sound level



Low sound quality



Sound skips frequently during playback.



Pairing

Pairing cannot be done.



One-touch connection (NFC)

Unable to connect the headset to a BLUETOOTH device with one-touch connection (NFC)



BLUETOOTH connection

Unable to make a BLUETOOTH connection



Distorted sound



The BLUETOOTH wireless communication range is short, or the sound skips.



The headset does not operate properly.



Phone calls

No voice from callers



Low voice from callers



Resetting or initializing the headset

- [Resetting the headset](#)

- [Initializing the headset to restore factory settings](#)



Table Of Contents

Help Guide MDR-ZX220BT.....	i
Getting started.....	i
BLUETOOTH connection.....	i
What you can do with the BLUETOOTH function.....	1
How to make a wireless connection to BLUETOOTH devices.....	2
Supplied accessories.....	i
Checking the package contents.....	3
About the supplied manuals.....	4
Features.....	i
What you can do with the headset.....	5
Parts and controls.....	i
Location and function of parts.....	6
About the indicator.....	8
Charging the headset.....	ii
System requirements for battery charge using USB.....	10
Charging the headset.....	11
Available operating time.....	13
Checking the remaining battery charge.....	14
Voice guidance.....	ii
About voice guidance.....	16
Making connections.....	ii
One-touch connection (NFC) compatible Android devices.....	ii
One-touch connection (NFC) with a smartphone (Android 4.1 or later).....	17
One-touch connection (NFC) with a smartphone (Android 2.3.3 or later, and less than Android 4.1).....	19
Disconnecting the smartphone by one touch (NFC).....	22
Switching the device by one touch (NFC).....	23
Android devices not compatible with one-touch connection (NFC).....	ii
Pairing and connecting with an Android smartphone.....	24
Connecting to a paired Android smartphone.....	27
iPhone (iOS devices).....	ii
Pairing and connecting with an iPhone.....	29
Connecting to a paired iPhone.....	32
Computers.....	ii
Pairing and connecting with a computer (Windows 10).....	34
Pairing and connecting with a computer (Windows 8/Windows 8.1).....	38
Pairing and connecting with a computer (Windows 7).....	41
Pairing and connecting with a computer (Windows Vista).....	44

Connecting to a paired computer (Windows 10).....	47
Connecting to a paired computer (Windows 8/Windows 8.1).....	50
Connecting to a paired computer (Windows 7).....	53
Connecting to a paired computer (Windows Vista).....	55
Other BLUETOOTH devices.....	iii
Pairing and connecting with other BLUETOOTH devices.....	58
Connecting to a paired BLUETOOTH device.....	60
Multi point connection.....	iii
Connecting the headset to both a music player and a smartphone or mobile phone.....	62
Connecting the headset to 2 Android smartphones.....	63
Connecting the headset to an Android smartphone and an iPhone.....	65
Listening to music.....	iii
Listening to music via a BLUETOOTH connection.....	iii
Listening to music from a device connected via BLUETOOTH.....	67
Controlling the audio device (BLUETOOTH connection).....	69
Disconnecting BLUETOOTH connection (after use).....	70
Supported codecs.....	iii
Supported codecs.....	71
Making phone calls.....	iii
Receiving a call.....	72
Making a call.....	74
Functions for a phone call.....	76
Disconnecting BLUETOOTH connection (after use).....	70
Important information.....	iii
Precautions.....	iii
Precautions.....	77
What is BLUETOOTH wireless technology?.....	78
Trademarks.....	iii
Trademarks.....	80
Support website.....	iii
Customer support websites.....	81
Troubleshooting.....	iv
What can I do to solve a problem?.....	82
Power.....	iv
The headset is not turned on.....	83
Charging.....	iv
Charging cannot be done.....	84
Charging time is too long.....	85
The headset cannot be recognized by a computer.....	86

The remaining battery charge of the headset is not displayed on the screen of an iPhone, iPad, or iPod touch.....	87
Sound.....	iv
No sound.....	88
Low sound level.....	89
Low sound quality.....	90
Sound skips frequently during playback.....	91
Pairing.....	iv
Pairing cannot be done.....	92
One-touch connection (NFC).....	iv
Unable to connect the headset to a BLUETOOTH device with one-touch connection (NFC).....	93
BLUETOOTH connection.....	iv
Unable to make a BLUETOOTH connection.....	94
Distorted sound.....	95
The BLUETOOTH wireless communication range is short, or the sound skips.....	96
The headset does not operate properly.....	97
Phone calls.....	iv
No voice from callers.....	98
Low voice from callers.....	99
Resetting or initializing the headset.....	v
Resetting the headset.....	100
Initializing the headset to restore factory settings.....	101

Wireless Stereo Headset
MDR-ZX220BT

What you can do with the BLUETOOTH function

The headset uses BLUETOOTH wireless technology, allowing you to listen to music or make phone calls wirelessly.

Listening to music

You can receive audio signals from a smartphone, mobile phone, or music player to enjoy music wirelessly.



Talking on the phone

You can make and receive a call with your hands free, while leaving your smartphone or mobile phone in your bag or pocket.

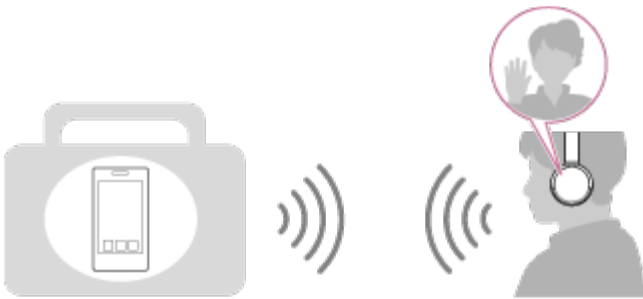

Wireless Stereo Headset
MDR-ZX220BT

How to make a wireless connection to BLUETOOTH devices

You can enjoy music and hands-free calling with the headset wirelessly by using your device's BLUETOOTH function. When connecting a device for the first time via BLUETOOTH, device registration (pairing) is needed.

Device registration (pairing)

The operation to register a device to be connected is called device registration (pairing).

If the device to be connected does not support the one-touch connection (NFC), operate the headset and the device to perform device registration (pairing).

If the device supports one-touch connection (NFC), you can just touch to perform device registration (pairing) and establish a BLUETOOTH connection.

Connecting the headset to a registered (paired) device

When the device is registered, it is not necessary to register it again. Connect to it with an appropriate method. For details, see "Making connections."

Wireless Stereo Headset
MDR-ZX220BT

Checking the package contents

After opening the package, check that all items in the list are included in the package. If items are missing, contact your dealer. Numbers in () indicate the item amount.

Wireless Stereo Headset (1)
Micro-USB cable (approx. 50 cm (19 3/4 in.)) (1)

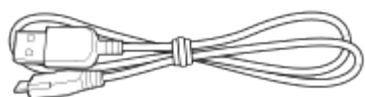

Reference Guide (1)
Operating Instructions (1)
Other documents (1 set) (*)

* May not be supplied in some countries or regions.

Wireless Stereo Headset
MDR-ZX220BT

About the supplied manuals

The following three manuals come with the headset.

Help Guide (this data)



Operation manual on the Web, which can be accessed by a PC or smartphone, provides the detailed information on how to use the headset and troubleshooting, etc.

Operating Instructions (enclosed paper)



Provides basic information on how to connect or use the headset.

Reference Guide (enclosed paper)



Provides precautions and specifications.

Wireless Stereo Headset
MDR-ZX220BT

What you can do with the headset

Wireless music playback. Basic control functions of the music player can be operated via BLUETOOTH connection.

Clear voice hands-free calling with built-in microphone

One-touch connection with Near Field Communication (NFC)

Voice guidance

Swivels for flat and easy portability

Micro-USB port for charging

Wireless Stereo Headset
MDR-ZX220BT

Location and function of parts

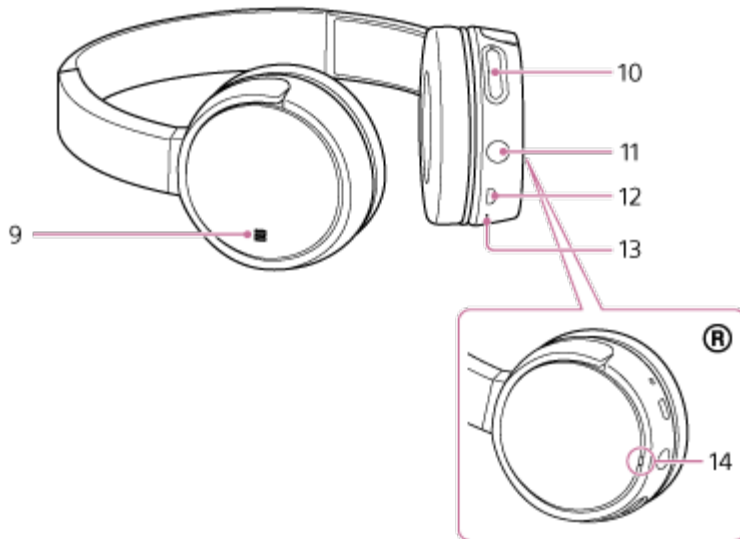
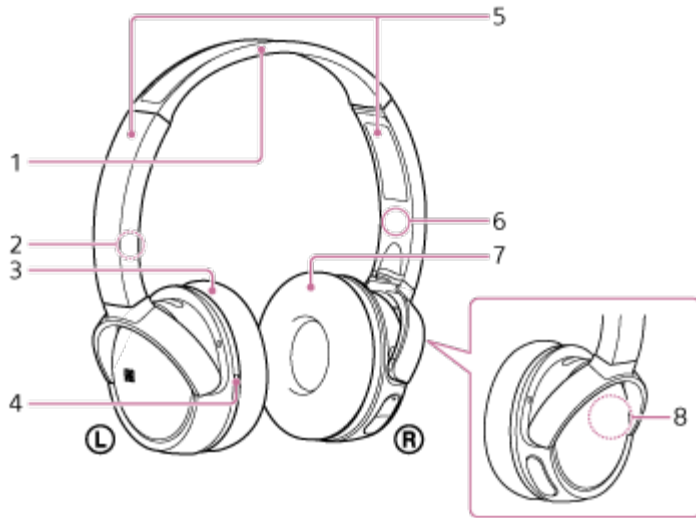

- 1. Headband
- 2. L mark
- 3. Ⓛ left unit
- 4. Tactile dot
The left unit has a tactile dot.
- 5. Slider
Slide to adjust the length of the headband.
- 6. R mark
- 7. Ⓡ right unit
- 8. Built-in antenna
A BLUETOOTH antenna is built into the headset.
- 9. Left unit
- 10. Power button
- 11. Call button
- 12. Play/Pause button
- 13. Stop button
- 14. Built-in antenna

9. N-mark
 - 10 +/-/⏪/⏩ buttons
 11. Multi-function button
 - 🔁 / ⏻ / ⏸ button
 - 12 Micro-USB port
 - Connect a computer to this port with the supplied micro-USB cable to charge the headset.
 - 13 Microphone
 - Picks up the sound of your voice when talking on the phone.
 - 14 Indicator (blue/red)
 - Lights up in red during charging.
 - Lights up in red or blue to indicate the power or communication status of the headset.
-

Related Topic

- [About the indicator](#)
- [Checking the remaining battery charge](#)

Wireless Stereo Headset
MDR-ZX220BT

About the indicator

The indicator flashes in red or blue to indicate various statuses.

●: Turns on in blue/●: Turns on in red/-: Turns off

Turning on

- When turning on the headset by pressing and holding the  button for about 2 seconds when the headset is turned off.

● - ● (flashes two times)

Turning off

- When turning off the headset by pressing and holding the  button for about 2 seconds when the headset is turned on.

 (lights for about two seconds)

BLUETOOTH status indication

- Pairing mode
(Pressing and holding the  button for about 7 seconds when the headset is turned off)

● ● ● ● ● ● ● ● ● ●

- Not connected
● - - ● - - ● - - ● (one-second intervals)

- Connection process completed
● ● ● ● ● ● ● ● (flashes quickly for about five seconds)

- Connected
● - - - (about five-second interval) - - - ●

- Incoming call
● ● ● ● ● ● ● ●

Remaining battery charge indication

- High
● - - ● - - ●

- Medium
● - - ●

- Low (needs to charge)
●

For details, refer to “[Checking the remaining battery charge.](#)”

Charging

- While charging



Other

- Initialization completed



For details, refer to “[Initializing the headset to restore factory settings.](#)”

Hint

- When the remaining battery charge becomes low, the indicator turns from blue to red, except for pairing mode.

Wireless Stereo Headset
MDR-ZX220BT

System requirements for battery charge using USB

The headset contains a lithium ion rechargeable battery, which should be charged before using the headset for the first time.

Personal Computer with pre-installed with any of the following operating systems and USB port:

- When using Windows®
 - Windows® 10 Home / Windows® 10 Pro
 - Windows® 8.1 / Windows® 8.1 Pro
 - Windows® 8 / Windows® 8 Pro
 - Windows® 7 Home Basic / Home Premium / Professional / Ultimate
 - Windows Vista® (Service Pack 2 or later) Home Basic / Home Premium / Business / Ultimate / Media Center Edition 2005
- When using Mac
 - Mac OS X (version 10.8 or later)

Note

- Sony does not guarantee proper operation in all system environments.
- When using Windows 8.1 update using Windows Update.

Wireless Stereo Headset
MDR-ZX220BT

Charging the headset

The headset contains a lithium ion rechargeable battery. Charge the headset using the supplied micro-USB cable.

- 1 Connect the supplied micro-USB cable to the headset, and then connect the other end to a booted computer.

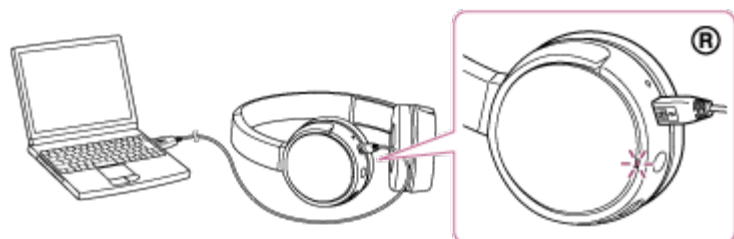

- Make sure that the indicator (red) lights up.
- Charging is completed in about 2.5 hours (*) and the indicator (red) goes off automatically.

* Time required for charging the empty battery to its full capacity.

Note

- The headset cannot be operated (turning on, BLUETOOTH pairing and connection, music playback, etc.) while charging or if kept connected to the computer after charging is complete.
- If the headset detects a problem while charging due to following causes, the indicator (red) may turn off, although charging is not complete. In this case, charge again within the charging temperature range. If the problem persists, consult your nearest Sony dealer.
 - Ambient temperature exceeds the charging temperature range of 5 °C – 35 °C(41 °F - 95 °F).
 - There is a problem with the battery.
- If the headset is not used for a long time, the indicator (red) may not light up when you connect the micro-USB cable to charge the headset. In this case, do not disconnect the micro-USB cable from the headset: wait a few minutes until the indicator (red) lights up.
- If the headset is not used for a long time, the battery may be quickly depleted, however, after a few recharges, the battery life will improve.
- If you store the headset for a long time, charge the battery to its full capacity once every 6 months to avoid over discharge.
- If the headset is not used for a long time, it may take longer to charge the battery.
- If the life of the built-in rechargeable battery drops significantly, the battery should be replaced. Consult your nearest Sony dealer for replacement of the rechargeable battery.
- Avoid exposure to temperature extremes, direct sunlight, moisture, sand, dust or mechanical shock. Never leave the headset in a car parked in the sun.
- If the computer enters into hibernation mode while connected to the headset, charging will not be completed properly. Check the setting of the computer before charging. The indicator (red) will go off automatically if the computer enters into hibernation mode. Charge the headset again in

this case.

- Use the supplied micro-USB cable only, and connect directly to a computer. Charging will not be completed properly by an indirect connection, such as via a USB hub.

Hint

- If charging starts while the headset is turned on, the headset will turn off automatically.

Wireless Stereo Headset
MDR-ZX220BT

Available operating time

The available operating times of the headset on a fully-charged battery are as follows:

- Wireless connection
 - Music Playback time (SBC/AAC): Max. 8 hours
 - Communication time: Max. 8 hours
 - Standby time: Max. 200 hours

Note

- Usage hours may be shorter depending on the Codec and the conditions of use.

Wireless Stereo Headset
MDR-ZX220BT

Checking the remaining battery charge

You can check the remaining battery charge of the rechargeable battery.

When you turn on the headset by pressing the  button, the indicator (blue) flashes two times, then the indicator (red) flashes. You can check the remaining battery charge by the number of times the indicator (red) flashes. You also hear voice guidance “Battery level low” when the remaining battery charge is low (needs to charge).

3 times  - -  - - : High

2 times  - - : Medium

1 time : Low (needs to charge) “Battery level low”

When the battery is almost empty

The indicator turns red. When the battery becomes empty, the headset sounds a warning beep, you hear voice guidance “Please recharge headset”, and the head set turns off automatically.

When you are using an iPhone, iPad, or iPod touch

When the headset is connected to an iPhone, iPad, or iPod touch (iOS 5.0 or later) that supports HFP (Hands-free Profile), it will show an icon that indicates the remaining battery charge of the headset on the screen.

Compatible devices

iPhone, iPad, or iPod touch (iOS 5.0 or later) supporting Hands-free Profile (HFP)

iOS 7.0 or later

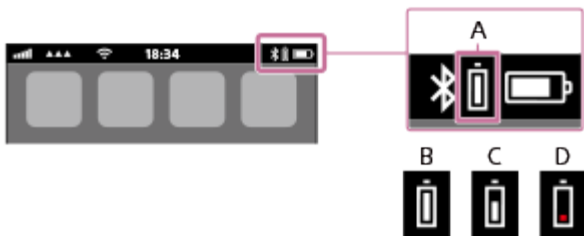

iOS 5.X / 6.X

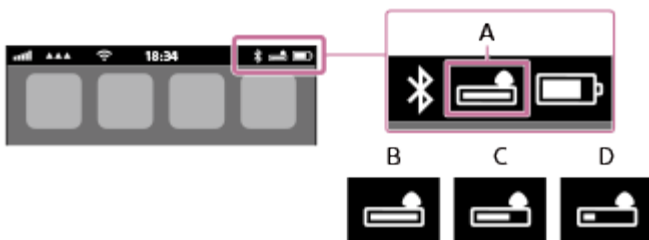

A: Remaining battery charge of the headset

B: High

C: Medium

D: Low (needs to charge)

Note

- If you connect the headset to an iPhone, iPad or iPod touch with “Media audio” (A2DP) only in a multi point connection, the remaining battery charge will not be displayed correctly.

Wireless Stereo Headset
MDR-ZX220BT

About voice guidance

You hear voice guidance on the following situations via the headset.

- When powering on: "Power on"
- If the battery is low when powering on: "Battery level low"
- When powering off: "Power off"
- When entering pairing mode: "BLUETOOTH pairing"
- When establishing a BLUETOOTH connection: "BLUETOOTH connected"
- When disconnecting a BLUETOOTH connection: "BLUETOOTH disconnected"
- When automatically turning off due to the low battery condition: "Please recharge headset"

Wireless Stereo Headset
MDR-ZX220BT

One-touch connection (NFC) with a smartphone (Android 4.1 or later)

By touching the headset with a smartphone, the headset turns on automatically and then pairs and makes a BLUETOOTH connection.

Compatible smartphones

NFC-compatible smartphones installed with Android 4.1 or later

NFC

NFC (Near Field Communication) is a technology enabling short-range wireless communication between various devices, such as smartphones and IC tags. Thanks to the NFC function, data communication - for example, BLUETOOTH pairing - can be achieved easily by simply touching NFC-compatible devices together (i.e., at the N-Mark symbol or location designated on each device).

1 Unlock the screen of the smartphone if it is locked.

2 Select [Setting] — [More].

3 Set the NFC function to on.



* The above procedure is an example. For details, refer to the operating instructions supplied with your Android smartphone.

4 Touch the headset with the smartphone.

- Touch the smartphone on the N-Mark of the headset. Keep touching the headset with the smartphone until the smartphone reacts.
- Refer to the operating instructions of the smartphone for the designated location to be touched on the smartphone.

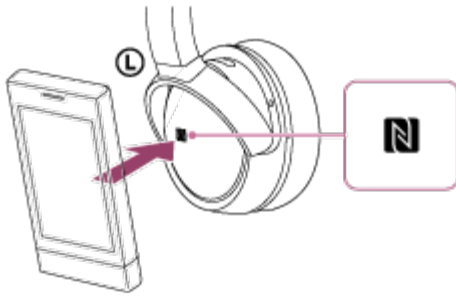

Follow the on-screen instructions to complete the pairing and connection.

When the headset is connected with the smartphone, the blue indicator starts flashing slowly. You hear voice guidance “BLUETOOTH connected”.

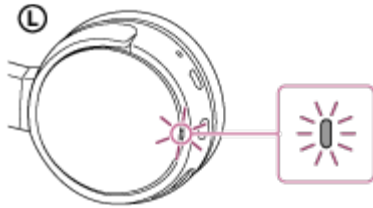

- To disconnect, touch the smartphone again.
- To connect a paired smartphone, perform steps 2 and 3.

Hint

- If you cannot connect the headset, try the following.
 - Unlock the screen of the smartphone if it is locked, and move the smartphone slowly over the N-Mark of the headset.
 - If the smartphone is in a case, remove the case.
- If you touch an NFC-compatible smartphone with the headset, the smartphone terminates BLUETOOTH connection with any current device, and connects to the headset (One-touch connection switching).

Related Topic

- [How to make a wireless connection to BLUETOOTH devices](#)
- [Disconnecting the smartphone by one touch \(NFC\)](#)
- [Switching the device by one touch \(NFC\)](#)
- [Listening to music from a device connected via BLUETOOTH](#)

Wireless Stereo Headset
MDR-ZX220BT

One-touch connection (NFC) with a smartphone (Android 2.3.3 or later, and less than Android 4.1)

By touching the headset with a smartphone, the headset turns on automatically and then pairs and makes a BLUETOOTH connection.

Compatible smartphones

NFC-compatible smartphones with Android 2.3.3 up to Android 4.0.4 (excluding Android 3.x)

NFC

NFC (Near Field Communication) is a technology enabling short-range wireless communication between various devices, such as smartphones and IC tags. Thanks to the NFC function, data communication - for example, BLUETOOTH pairing - can be achieved easily by simply touching NFC-compatible devices together (i.e., at the N-Mark symbol or location designated on each device).

1 Unlock the screen of the smartphone if it is locked.

2 Select [Setting] — [More].

3 Set the NFC function to on.



* The above procedure is an example. For details, refer to the operating instructions supplied with your Android smartphone.

4 Download and install the app “NFC Easy Connect.”

If you have already downloaded the app, proceed to step 5.

“NFC Easy Connect” is a free Android app you can download from Google Play™.

Download the app by searching for “NFC Easy Connect” or access it by using the two-dimensional code. Fees may be charged for downloading the app.

Access the following Web site:

<https://play.google.com/store/apps/details?id=com.sony.easyconnect>

The App may not be available in some countries and/or regions.

Use a two-dimensional code reader app.



5 Start the app “NFC Easy Connect” on the smartphone.

Make sure that the app screen is displayed on the smartphone.

6 Touch the headset with the smartphone.

- Touch the smartphone on the N-Mark of the headset. Keep touching the headset with the smartphone until the smartphone reacts.
- Refer to the operating instructions of the smartphone for the designated location to be touched on the smartphone.

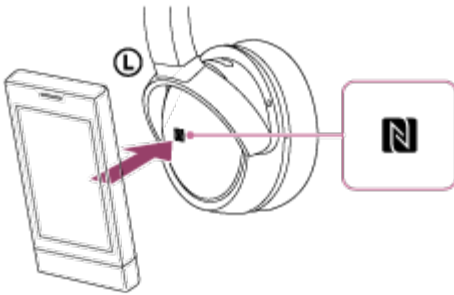

Follow the on-screen instructions to complete the pairing and connection.

When the headset is connected with the smartphone, the blue indicator starts flashing slowly. You hear voice guidance “BLUETOOTH connected”.

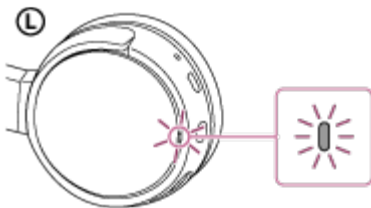

- To disconnect, touch the smartphone again.
- To connect a paired smartphone, perform steps 5 and 6.

- If you cannot connect the headset, try the following.
 - Start the app “NFC Easy Connect” on the smartphone, and move the smartphone slowly over the N-Mark of the headset.
 - If the smartphone is in a case, remove the case.
 - Make sure that the app “NFC Easy Connect” screen is displayed on the smartphone.
- If you touch an NFC-compatible smartphone with the headset, the smartphone terminates BLUETOOTH connection with any current device, and connects to the headset (One-touch connection switching).

Related Topic

- [How to make a wireless connection to BLUETOOTH devices](#)
- [Disconnecting the smartphone by one touch \(NFC\)](#)
- [Switching the device by one touch \(NFC\)](#)
- [Listening to music from a device connected via BLUETOOTH](#)

Wireless Stereo Headset
MDR-ZX220BT

Disconnecting the smartphone by one touch (NFC)

You can disconnect the headset from the connected smartphone by touching the headset with it.

- 1 Unlock the screen of the smartphone if it is locked.

If you installed the app “NFC Easy Connect” in the smartphone, start the app “NFC Easy Connect.”

- 2 Touch the headset with the smartphone.

Touch the smartphone on the N-Mark of the headset. You hear voice guidance “BLUETOOTH disconnected”.

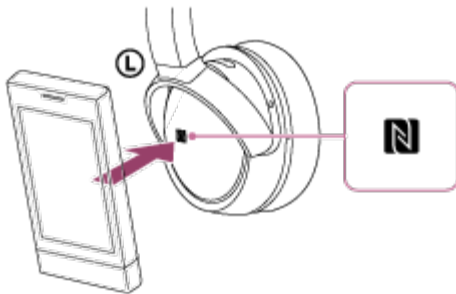

Note

- After the headset is disconnected from the smartphone, if no operation is performed for about 5 minutes, the headset turns off automatically. To turn off the headset before that, press and hold the  button for about 2 seconds. You hear voice guidance “Power off”, the indicator (blue) goes off, then the headset turns off.

Wireless Stereo Headset
MDR-ZX220BT

Switching the device by one touch (NFC)

- When the headset is connected with a BLUETOOTH device, if you touch an NFC-compatible smartphone on the headset, the headset is connected with the smartphone that touched on the headset most recently (One-touch connection switching). However, if you are talking on a BLUETOOTH mobile phone connected to the headset, you cannot switch the BLUETOOTH connection by one touch.
- When the headset is connected with an NFC-compatible smartphone, if you touch the smartphone on another NFC-compatible BLUETOOTH headset or BLUETOOTH speaker, the smartphone disconnects from the headset, and connects to the BLUETOOTH device it touched.

Note

- Unlock the screen of the smartphone if it is locked.
- If you installed the app “NFC Easy Connect” in the smartphone, start the app “NFC Easy Connect.”

Wireless Stereo Headset
MDR-ZX220BT

Pairing and connecting with an Android smartphone

Pairing is the process required to create a link between BLUETOOTH devices to allow wireless connection. You must pair a device with the headset to be able to make a BLUETOOTH connection for the first time. Before you start pairing operation, make sure that:

- The smartphone is placed within 1 m(3 feet) of the headset.
- The headset is charged sufficiently.
- The operating instructions of the smartphone is on hand.

1 Enter pairing mode on this headset.

When you pair the headset with a device for the first time after you bought it, or after you initialized the headset (the headset has no pairing information), press and hold the  button for about 2 seconds when the headset is turned off. The headset enters pairing mode automatically.

When you pair a 2nd or subsequent device (the headset has pairing information for other devices), press and hold the  button for about 7 seconds.

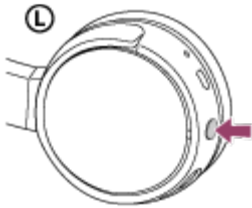

Make sure that the indicator flashes blue and red alternately after you release the button. You hear voice guidance "BLUETOOTH pairing".

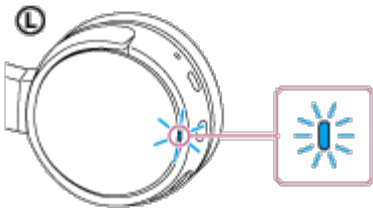

2 Unlock the screen of the Android smartphone if it is locked.

3 Search for this headset on the smartphone.

1. Select [Setting] - [Bluetooth].
2. Touch [] next to [Bluetooth] to turn on the BLUETOOTH function.

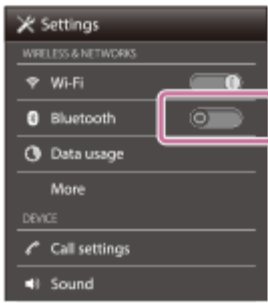

3. Touch [Bluetooth].

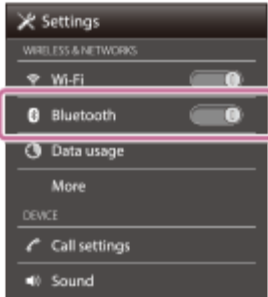

4. Touch [Search for devices].

5. Touch [MDR-ZX220BT].



If passkey (*) input is required on the display of the smartphone, input “0000.”

The headset and the smartphone are paired with each other and connected. You hear voice guidance “BLUETOOTH connected”.

If they are not connected, see [“Connecting to a paired Android smartphone.”](#)

If [MDR-ZX220BT] does not appear on the display, try again from step 3.

* A Passkey may be called a “Passcode,” a “PIN code,” or a “Password.”

Note

- If pairing is not established within about 5 minutes, pairing mode will be canceled and the headset will turn off. In this case, start over from step 1.
- Once BLUETOOTH devices are paired, there is no need to pair them again, except in the following cases:

- Pairing information has been deleted after repair, etc.
 - The headset is already paired with 8 devices and another device is to be paired.
The headset can be paired with up to 8 devices. If a new device is paired after 8 devices are already paired, the paired device with the oldest connection time is replaced by the new one.
 - When the pairing information for the headset has been deleted from the BLUETOOTH device.
 - When the headset is initialized, all pairing information is deleted.
In this case, delete the pairing information of the headset from the BLUETOOTH device, and then pair them again.
- The headset can be paired with multiple devices, but can only play music from one paired device at a time.

Hint

- The above procedure is an example. For details, refer to the operating instructions supplied with your Android smartphone.
- To delete all pairing information, see “[Initializing the headset to restore factory settings.](#)”

Related Topic

- [How to make a wireless connection to BLUETOOTH devices](#)
- [Connecting to a paired Android smartphone](#)
- [Listening to music from a device connected via BLUETOOTH](#)
- [Initializing the headset to restore factory settings](#)

Wireless Stereo Headset
MDR-ZX220BT

Connecting to a paired Android smartphone

1. Unlock the screen of the Android smartphone if it is locked.

2. Turn on the headset.

Press and hold the  button for about 2 seconds.

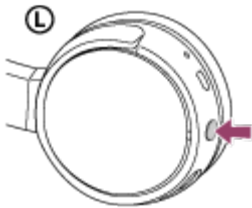

Make sure that the indicator (blue) flashes after you release the button. You hear voice guidance “Power on”.

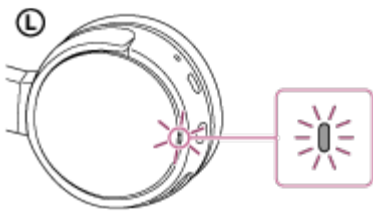

After the headset turns on, if it has automatically connected to the last connected device, you hear voice guidance “BLUETOOTH connected”.

Check the connection status on the Android smartphone. If not connected, proceed to step 3.

3. Display the devices paired with the smartphone.

1. Select [Setting] - [Bluetooth].
2. Touch [] next to [Bluetooth] to turn on the BLUETOOTH function.

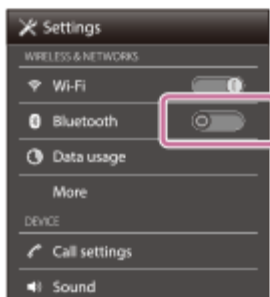

3. Touch [Bluetooth].

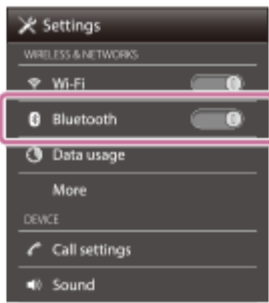

4. Touch [MDR-ZX220BT].

You hear voice guidance “BLUETOOTH connected”.



Hint

- The above procedure is an example. For details, refer to the operating instructions supplied with your smartphone.
- If the smartphone was connected with the headset the last time, an HFP/HSP connection is made when you turn on the headset. While the headset is on, you can make an A2DP connection (music playback) by pressing the ►|| button.

Note

- If the headset tries to make a connection with a previously connected BLUETOOTH device, you may not be able to connect to the device you want to. If connection fails, terminate the BLUETOOTH connection from the device that was previously connected.

Related Topic

- [How to make a wireless connection to BLUETOOTH devices](#)
- [Pairing and connecting with an Android smartphone](#)
- [Listening to music from a device connected via BLUETOOTH](#)

Wireless Stereo Headset
MDR-ZX220BT

Pairing and connecting with an iPhone

Pairing is the process required to create a link between BLUETOOTH devices to allow wireless connection. You must pair a device with the headset to be able to make a BLUETOOTH connection for the first time. Before you start pairing operation, make sure that:

- The iPhone is placed within 1 m(3 feet) of the headset.
- The headset is charged sufficiently.
- The operating instructions of the iPhone is on hand.

1 Enter pairing mode on this headset.

When you pair the headset with a device for the first time after you bought it, or after you initialized the headset (the headset has no pairing information), press and hold the  button for about 2 seconds when the headset is turned off. The headset enters pairing mode automatically.

When you pair a 2nd or subsequent device (the headset has pairing information for other devices), press and hold the  button for about 7 seconds.

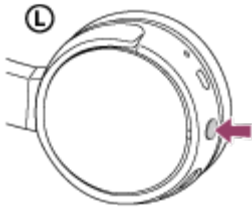

Make sure that the indicator flashes blue and red alternately after you release the button. You hear voice guidance "BLUETOOTH pairing".

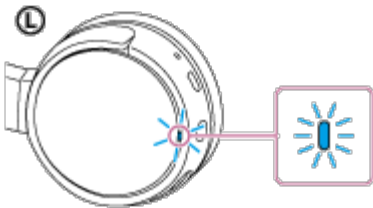

2 Unlock the screen of the iPhone if it is locked.

3 Select the BLUETOOTH setting on the iPhone.

1. Select [Settings].
2. Touch [Bluetooth].

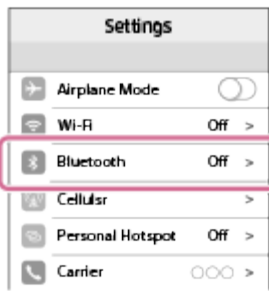

3. Touch [] to change it to [] (turn on the BLUETOOTH function).

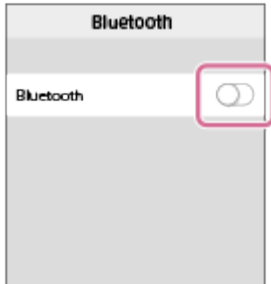

4 Touch [MDR-ZX220BT].



If passkey (*) input is required on the display of the iPhone, input “0000.”

The headset and the iPhone are paired with each other and connected. You hear voice guidance “BLUETOOTH connected”.

If they are not connected, see “[Connecting to a paired iPhone.](#)”

If [MDR-ZX220BT] does not appear on the display, try again from step 3.

* A Passkey may be called a “Passcode,” a “PIN code,” or a “Password.”

Note

- If pairing is not established within about 5 minutes, pairing mode will be canceled and the headset will turn off. In this case, start over from step 1.
- Once BLUETOOTH devices are paired, there is no need to pair them again, except in the following cases:
 - Pairing information has been deleted after repair, etc.
 - The headset is already paired with 8 devices and another device is to be paired.
The headset can be paired with up to 8 devices. If a new device is paired after 8 devices are already paired, the paired device with the oldest connection time is replaced by the new one.
 - When the pairing information for the headset has been deleted from the BLUETOOTH device.
 - When the headset is initialized, all pairing information is deleted.
In this case, delete the pairing information of the headset from the BLUETOOTH device, and then pair them again.

- If the pairing information was deleted by initializing the headset, etc., delete from your iPhone the pairing information for the headset, and then pair them again.
- The headset can be paired with multiple devices, but can only play music from one paired device at a time.

Hint

- The above procedure is an example. For details, refer to the operating instructions supplied with your iPhone.
- To delete all pairing information, see “[Initializing the headset to restore factory settings.](#)”

Related Topic

- [How to make a wireless connection to BLUETOOTH devices](#)
- [Connecting to a paired iPhone](#)
- [Listening to music from a device connected via BLUETOOTH](#)
- [Initializing the headset to restore factory settings](#)

Wireless Stereo Headset
MDR-ZX220BT

Connecting to a paired iPhone

1. Unlock the screen of the iPhone if it is locked.

2. Turn on the headset.

Press and hold the  button for about 2 seconds.

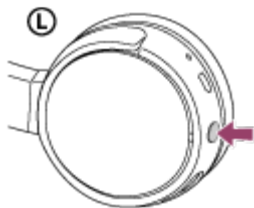

Make sure that the indicator (blue) flashes after you release the button. You hear voice guidance “Power on”.

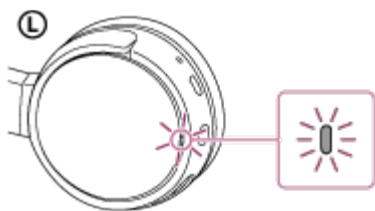

After the headset turns on, if it has automatically connected to the last connected device, you hear voice guidance “BLUETOOTH connected”.

Check the connection status on the iPhone. If not connected, proceed to step 3.

3. Display the devices paired with the iPhone.

1. Select [Settings].
2. Touch [Bluetooth].



3. Touch [] to change it to [] (turn on the BLUETOOTH function).

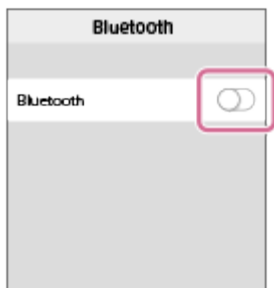

4 Touch [MDR-ZX220BT].

You hear voice guidance “BLUETOOTH connected”.

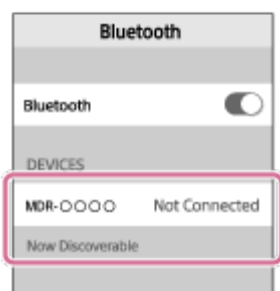

Hint

- The above procedure is an example. For details, refer to the operating instructions supplied with your iPhone.
- If the iPhone was connected with the headset the last time, an HFP/HSP connection is made when you turn on the headset. While the headset is on, you can make an A2DP connection (music playback) by pressing the  button.

Note

- If the headset tries to make a connection with a previously connected BLUETOOTH device, you may not be able to connect to the device you want to. If connection fails, terminate the BLUETOOTH connection from the device that was previously connected.

Related Topic

- [How to make a wireless connection to BLUETOOTH devices](#)
- [Pairing and connecting with an iPhone](#)
- [Listening to music from a device connected via BLUETOOTH](#)

Wireless Stereo Headset
MDR-ZX220BT

Pairing and connecting with a computer (Windows 10)

Pairing is the process required to create a link between BLUETOOTH devices to allow wireless connection. You must pair a device with the headset to be able to make a BLUETOOTH connection for the first time.

Before you start pairing operation, make sure that:

- Your computer has a BLUETOOTH function that supports music playback connections (A2DP).
- The computer is placed within 1 m(3 feet) of the headset.
- The headset is charged sufficiently.
- The operating instructions of the computer is on hand.
- Depending on the computer, the built-in BLUETOOTH adaptor should be turned on. For whether or not a BLUETOOTH adaptor is incorporate, and for how to turn it on, refer to the operating instructions supplied with the computer.

1 Enter pairing mode on this headset.

When you pair the headset with a device for the first time after you bought it, or after you initialized the headset (the headset has no pairing information), press and hold the  button for about 2 seconds when the headset is turned off. The headset enters pairing mode automatically.

When you pair a 2nd or subsequent device (the headset has pairing information for other devices), press and hold the  button for about 7 seconds.

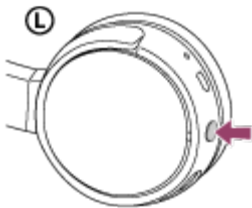

Make sure that the indicator flashes blue and red alternately after you release the button. You hear voice guidance "BLUETOOTH pairing".

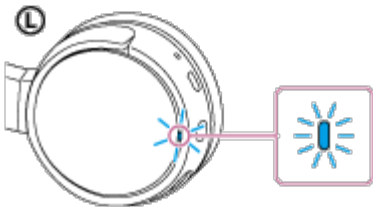

2 Resume the computer from sleep mode.

3 Register the headset using the computer.

1. Click the [Start] button, then [Settings].

2. Click [Devices].

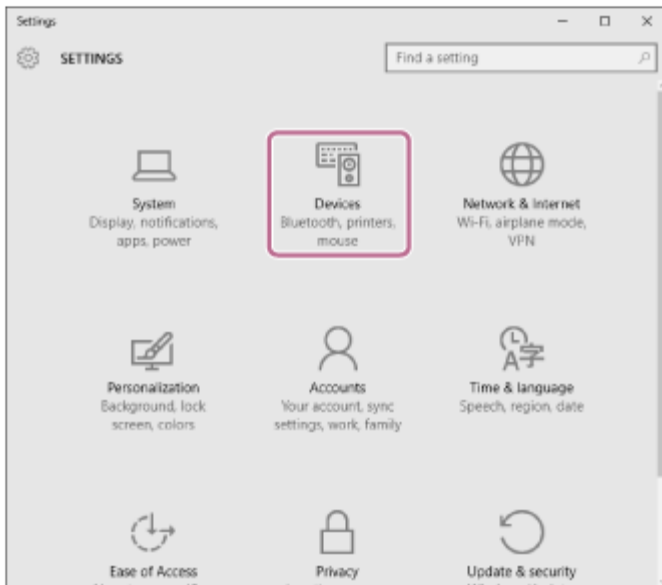

3. Click the [Bluetooth] tab, then click the [Bluetooth] button to turn on the BLUETOOTH function.

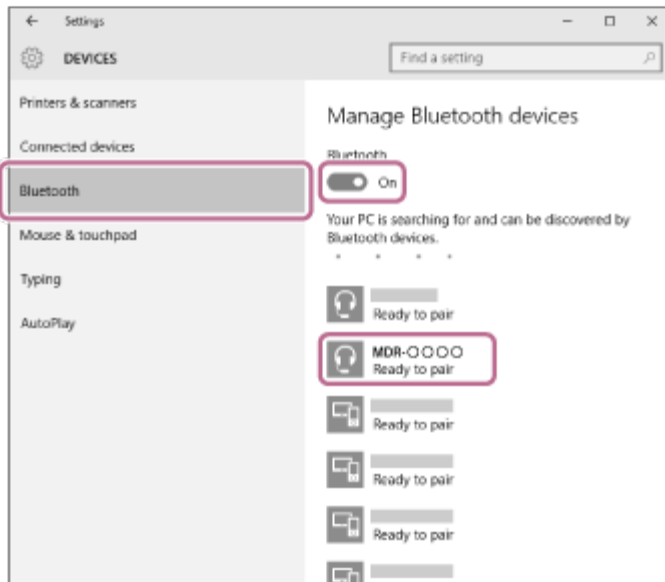

4. Select [MDR-ZX220BT], then click [Pair].

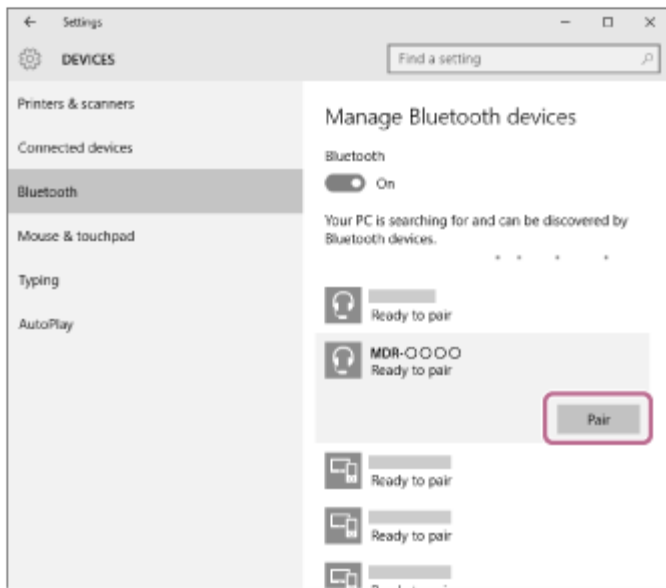

If passkey (*) input is required on the display of the computer, input “0000.”

The headset and the computer are paired with each other and connected.

You hear voice guidance “BLUETOOTH connected”.

If they are not connected, refer to [“Connecting to a paired computer \(Windows 10\).”](#)

If [MDR-ZX220BT] does not appear on the display, try again from step 3.

* A Passkey may be called a “Passcode,” a “PIN code,” or a “Password.”

Note

- If pairing is not established within about 5 minutes, pairing mode will be canceled and the headset will turn off. In this case, start over from step 1.
- Once BLUETOOTH devices are paired, there is no need to pair them again, except in the following cases:
 - Pairing information has been deleted after repair, etc.
 - The headset is already paired with 8 devices and another device is to be paired.
The headset can be paired with up to 8 devices. If a new device is paired after 8 devices are already paired, the paired device with the oldest connection time is replaced by the new one.
 - When the pairing information for the headset has been deleted from the BLUETOOTH device.
 - When the headset is initialized, all pairing information is deleted.
In this case, delete the pairing information of the headset from the BLUETOOTH device, and then pair them again.
- The headset can be paired with multiple devices, but can only play music from one paired device at a time.

Hint

- The above procedure is an example. For details, refer to the operating instructions supplied with your computer.
- To delete all pairing information, refer to [“Initializing the headset to restore factory settings.”](#)

Related Topic

- [How to make a wireless connection to BLUETOOTH devices](#)

- Connecting to a paired computer (Windows 10)
- Listening to music from a device connected via BLUETOOTH
- Disconnecting BLUETOOTH connection (after use)
- Initializing the headset to restore factory settings

Wireless Stereo Headset
MDR-ZX220BT

Pairing and connecting with a computer (Windows 8/Windows 8.1)

Pairing is the process required to create a link between BLUETOOTH devices to allow wireless connection. You must pair a device with the headset to be able to make a BLUETOOTH connection for the first time.

Before you start pairing operation, make sure that:

- Your computer has a BLUETOOTH function that supports music playback connections (A2DP).
- The computer is placed within 1 m(3 feet) of the headset.
- The headset is charged sufficiently.
- The operating instructions of the computer is on hand.
- Depending on the computer, the built-in BLUETOOTH adaptor should be turned on. For whether or not a BLUETOOTH adaptor is incorporate, and for how to turn it on, refer to the operating instructions supplied with the computer.

1 Enter pairing mode on this headset.

When you pair the headset with a device for the first time after you bought it, or after you initialized the headset (the headset has no pairing information), press and hold the  button for about 2 seconds when the headset is turned off. The headset enters pairing mode automatically.

When you pair a 2nd or subsequent device (the headset has pairing information for other devices), press and hold the  button for about 7 seconds.

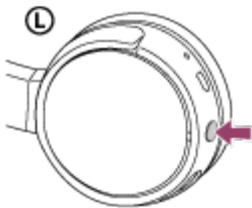

Make sure that the indicator flashes blue and red alternately after you release the button. You hear voice guidance "BLUETOOTH pairing".

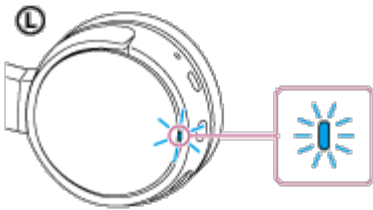

2 Resume the computer from sleep mode.

3 Register the headset using the computer.

1. Move the mouse pointer to the top-right corner of the screen (when using a touch panel, swipe from the right edge of

the screen), then select [Settings] from the Charm Bar.



2. Select [Change PC settings] of the [Settings] charm.

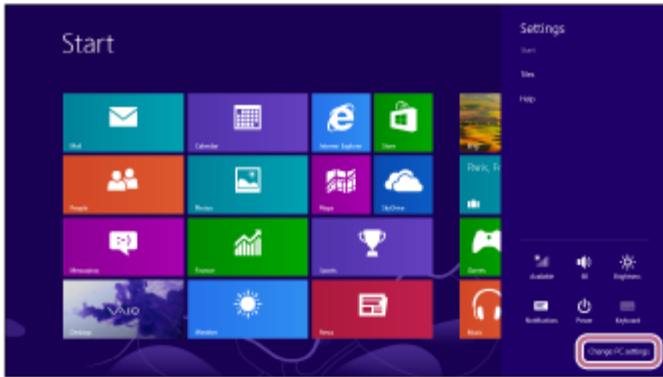

3. Select [Devices] of [PC settings].

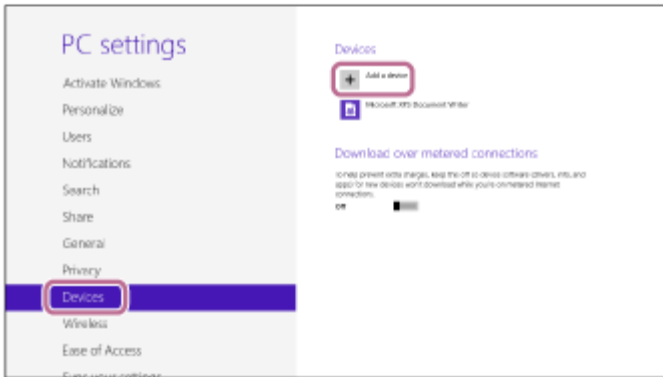

4. Select [Add a device].

5. Select [MDR-ZX220BT].

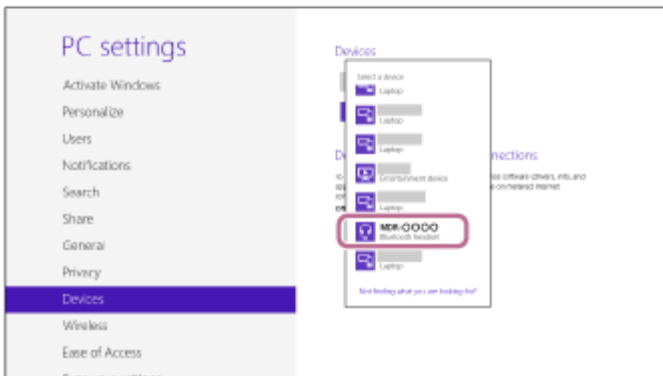

If passkey (*) input is required on the display of the computer, input "0000."

The headset and the computer are paired with each other and connected. You hear voice guidance "BLUETOOTH connected".

If they are not connected, see "[Connecting to a paired computer \(Windows 8/Windows 8.1\)](#)."

If [MDR-ZX220BT] does not appear on the display, try again from step 3.

* A Passkey may be called a "Passcode," a "PIN code," or a "Password."

Note

- If pairing is not established within about 5 minutes, pairing mode will be canceled and the headset will turn off. In this case, start over from step 1.
- Once BLUETOOTH devices are paired, there is no need to pair them again, except in the following cases:
 - Pairing information has been deleted after repair, etc.
 - The headset is already paired with 8 devices and another device is to be paired.
The headset can be paired with up to 8 devices. If a new device is paired after 8 devices are already paired, the paired device with the oldest connection time is replaced by the new one.
 - When the pairing information for the headset has been deleted from the BLUETOOTH device.
 - When the headset is initialized, all pairing information is deleted.
In this case, delete the pairing information of the headset from the BLUETOOTH device, and then pair them again.
- The headset can be paired with multiple devices, but can only play music from one paired device at a time.

Hint

- The above procedure is an example. For details, refer to the operating instructions supplied with your computer.
- To delete all pairing information, see "[Initializing the headset to restore factory settings](#)."

Related Topic

- [How to make a wireless connection to BLUETOOTH devices](#)
- [Connecting to a paired computer \(Windows 8/Windows 8.1\)](#)
- [Listening to music from a device connected via BLUETOOTH](#)
- [Disconnecting BLUETOOTH connection \(after use\)](#)
- [Initializing the headset to restore factory settings](#)

Wireless Stereo Headset
MDR-ZX220BT

Pairing and connecting with a computer (Windows 7)

Pairing is the process required to create a link between BLUETOOTH devices to allow wireless connection. You must pair a device with the headset to be able to make a BLUETOOTH connection for the first time.

Before you start pairing operation, make sure that:

- Your computer has a BLUETOOTH function that supports music playback connections (A2DP).
- The computer is placed within 1 m(3 feet) of the headset.
- The headset is charged sufficiently.
- The operating instructions of the computer is on hand.
- Depending on the computer, the built-in BLUETOOTH adaptor should be turned on. For whether or not a BLUETOOTH adaptor is incorporate, and for how to turn it on, refer to the operating instructions supplied with the computer.

1 Enter pairing mode on this headset.

When you pair the headset with a device for the first time after you bought it, or after you initialized the headset (the headset has no pairing information), press and hold the  button for about 2 seconds when the headset is turned off. The headset enters pairing mode automatically.

When you pair a 2nd or subsequent device (the headset has pairing information for other devices), press and hold the  button for about 7 seconds.

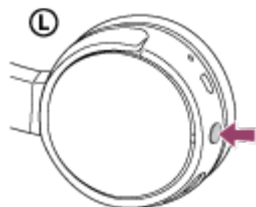

Make sure that the indicator flashes blue and red alternately after you release the button. You hear voice guidance "BLUETOOTH pairing".

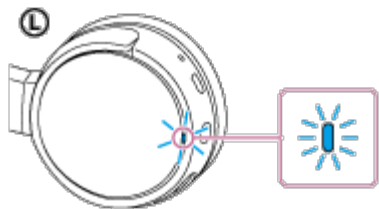

2 Resume the computer from sleep mode.

3 Search for the headset using the computer.

1. Click the [Start] button, then [Devices and Printers].

2. Click [Add a device].

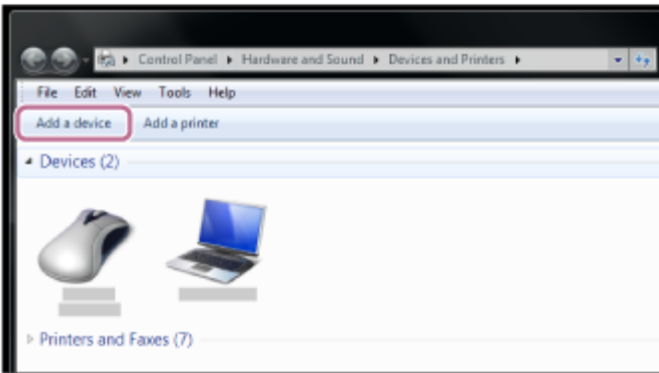

3. Select [MDR-ZX220BT], then click [Next].

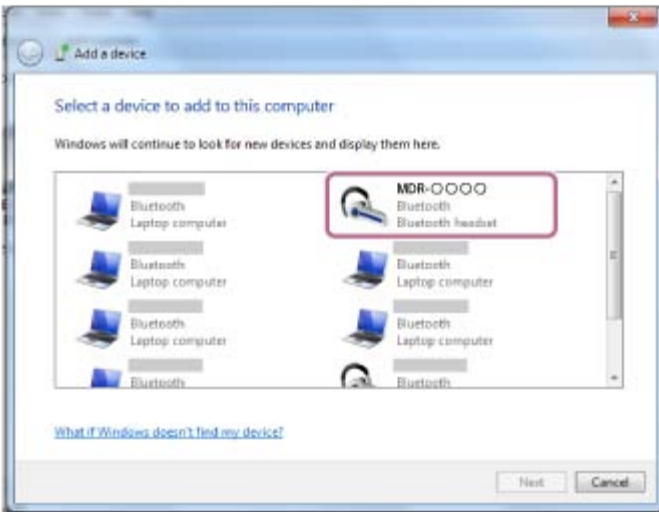

If passkey (*) input is required on the display of the computer, input "0000."

The headset and the computer are paired with each other and connected. You hear voice guidance "BLUETOOTH connected".

If they are not connected, see "[Connecting to a paired computer \(Windows 7\).](#)"

If [MDR-ZX220BT] does not appear on the display, try again from step 3.

* A Passkey may be called a "Passcode," a "PIN code," or a "Password."

Note

- If pairing is not established within about 5 minutes, pairing mode will be canceled and the headset will turn off. In this case, start over from step 1.
- Once BLUETOOTH devices are paired, there is no need to pair them again, except in the following cases:
 - Pairing information has been deleted after repair, etc.
 - The headset is already paired with 8 devices and another device is to be paired.
The headset can be paired with up to 8 devices. If a new device is paired after 8 devices are already paired, the paired device with the oldest connection time is replaced by the new one.
 - When the pairing information for the headset has been deleted from the BLUETOOTH device.
 - When the headset is initialized, all pairing information is deleted.
In this case, delete the pairing information of the headset from the BLUETOOTH device, and then pair them again.
- The headset can be paired with multiple devices, but can only play music from one paired device at a time.

Hint

- The above procedure is an example. For details, refer to the operating instructions supplied with your computer.
- To delete all pairing information, see "[Initializing the headset to restore factory settings.](#)"

Related Topic

- [How to make a wireless connection to BLUETOOTH devices](#)
- [Connecting to a paired computer \(Windows 7\)](#)
- [Listening to music from a device connected via BLUETOOTH](#)
- [Disconnecting BLUETOOTH connection \(after use\)](#)
- [Initializing the headset to restore factory settings](#)

Wireless Stereo Headset
MDR-ZX220BT

Pairing and connecting with a computer (Windows Vista)

Pairing is the process required to create a link between BLUETOOTH devices to allow wireless connection. You must pair a device with the headset to be able to make a BLUETOOTH connection for the first time.

Before you start pairing operation, make sure that:

- Your computer has a BLUETOOTH function that supports music playback connections (A2DP).
- The computer is placed within 1 m(3 feet) of the headset.
- The headset is charged sufficiently.
- The operating instructions of the computer is on hand.
- Depending on the computer, the built-in BLUETOOTH adaptor should be turned on. For whether or not a BLUETOOTH adaptor is incorporate, and for how to turn it on, refer to the operating instructions supplied with the computer.

1 Enter pairing mode on this headset.

When you pair the headset with a device for the first time after you bought it, or after you initialized the headset (the headset has no pairing information), press and hold the  button for about 2 seconds when the headset is turned off. The headset enters pairing mode automatically.

When you pair a 2nd or subsequent device (the headset has pairing information for other devices), press and hold the  button for about 7 seconds.

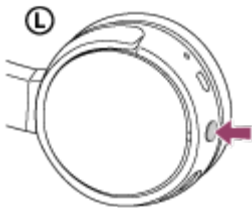

Make sure that the indicator flashes blue and red alternately after you release the button. You hear voice guidance "BLUETOOTH pairing".

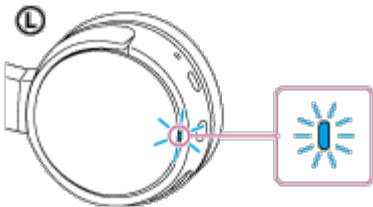

2 Resume the computer from sleep mode.

3 Register the computer to the headset.

1. Right-click the BLUETOOTH icon on the windows toolbar, then click [Add New Connection].

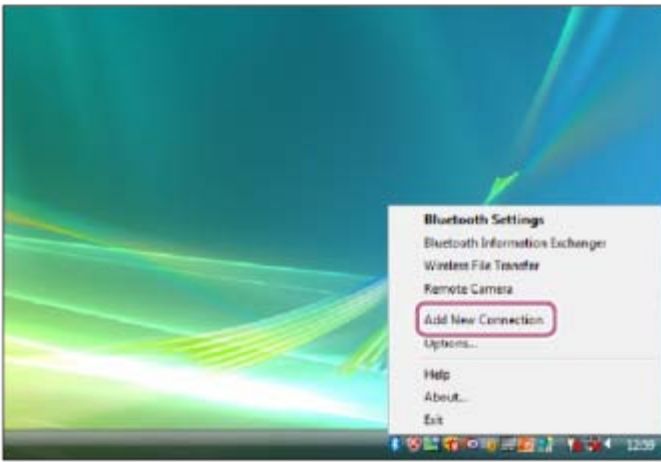

2. Click [Next] in [Add New Connection Wizard].

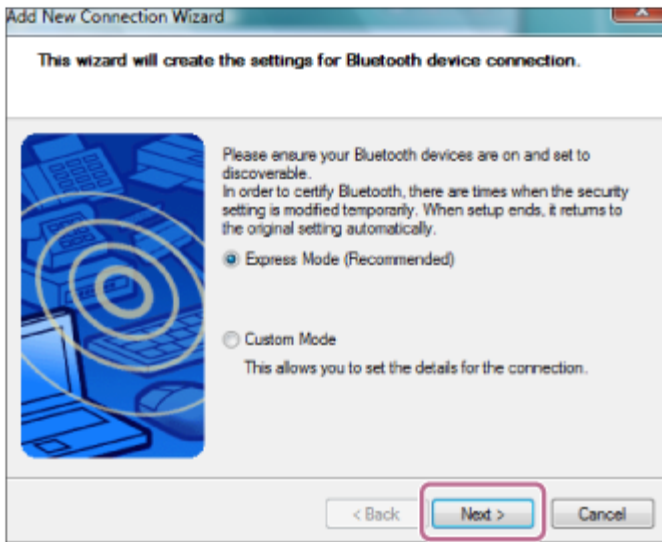

3. Select [MDR-ZX220BT] in the [Select a device] screen, then click [Next].



If passkey (*) input is required on the display of the computer, input "0000."

The headset and the computer are paired with each other and connected. You hear voice guidance "BLUETOOTH connected".

If they are not connected, see "[Connecting to a paired computer \(Windows Vista\).](#)"

If [MDR-ZX220BT] does not appear on the display, try again from step 3.

* A Passkey may be called a “Passcode,” a “PIN code,” or a “Password.”

Note

- If pairing is not established within about 5 minutes, pairing mode will be canceled and the headset will turn off. In this case, start over from step 1.
- Once BLUETOOTH devices are paired, there is no need to pair them again, except in the following cases:
 - Pairing information has been deleted after repair, etc.
 - The headset is already paired with 8 devices and another device is to be paired.
The headset can be paired with up to 8 devices. If a new device is paired after 8 devices are already paired, the paired device with the oldest connection time is replaced by the new one.
 - When the pairing information for the headset has been deleted from the BLUETOOTH device.
 - When the headset is initialized, all pairing information is deleted.
In this case, delete the pairing information of the headset from the BLUETOOTH device, and then pair them again.
- The headset can be paired with multiple devices, but can only play music from one paired device at a time.

Hint

- The above procedure is an example. For details, refer to the operating instructions supplied with your computer.
- To delete all pairing information, see “[Initializing the headset to restore factory settings.](#)”

Related Topic

- [How to make a wireless connection to BLUETOOTH devices](#)
- [Connecting to a paired computer \(Windows Vista\)](#)
- [Listening to music from a device connected via BLUETOOTH](#)
- [Disconnecting BLUETOOTH connection \(after use\)](#)
- [Initializing the headset to restore factory settings](#)

Wireless Stereo Headset
MDR-ZX220BT

Connecting to a paired computer (Windows 10)

Before starting the operation, make sure the following:

- Depending on the computer, the built-in BLUETOOTH adaptor should be turned on. For whether or not a BLUETOOTH adaptor is incorporate, and for how to turn it on, refer to the operating instructions supplied with the computer.

1 Resume the computer from sleep mode.

2 Turn on the headset.

Press and hold the  button for about 2 seconds.

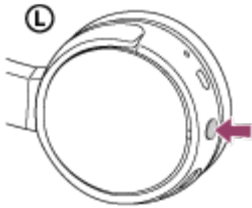

Make sure that the indicator (blue) flashes after you release the button. You hear voice guidance “Power on”.

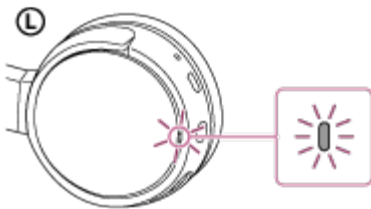

After the headset turns on, if it has automatically connected to the last connected device, you hear voice guidance “BLUETOOTH connected”.

Use the computer to check whether the connection is established, and if it is not established, proceed to step 3.

If the computer has connected to the last BLUETOOTH device connected, disconnect it, then proceed to the next step.

3 Select the headset using the computer.

1. Right-click the volume icon on the windows toolbar, then click [Playback devices].

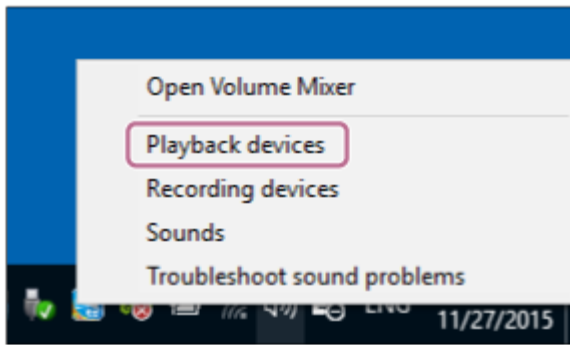

2. Right-click [MDR-ZX220BT].

If [MDR-ZX220BT] is not displayed, right-click on the [Sound] screen, then select [Show Disabled Devices].

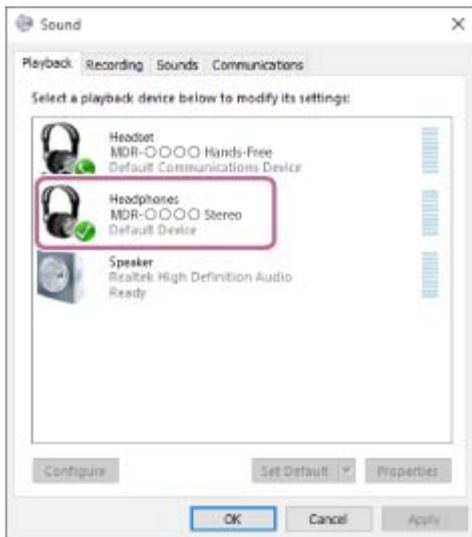

3. Click [Connect].

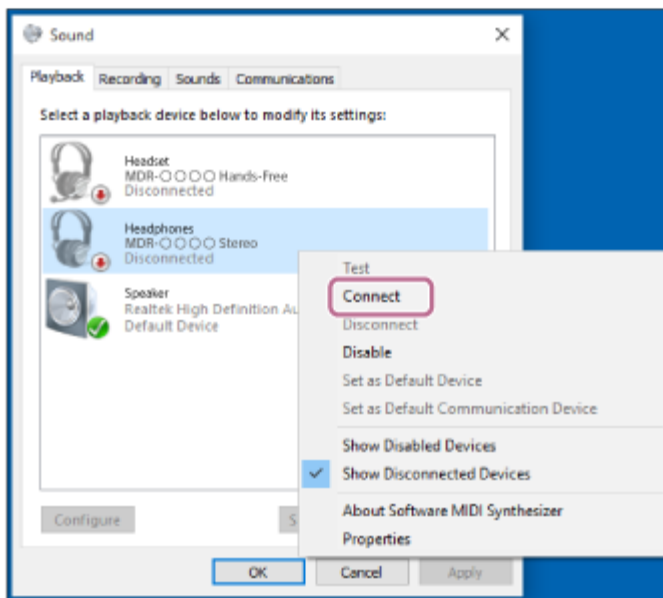

The connection is established.



Hint

- The above procedure is an example. For details, refer to the operating instructions supplied with your computer.
- If the computer was connected with the headset the last time, an HFP/HSP connection is made when you turn on the headset. While the headset is on, you can make an A2DP connection (music playback) by pressing the ►|| button.

Note

- If the headset tries to make a connection with a previously connected BLUETOOTH device, you may not be able to connect to the device you want to. If connection fails, terminate the BLUETOOTH connection from the device that was previously connected.

Related Topic

- [How to make a wireless connection to BLUETOOTH devices](#)
- [Pairing and connecting with a computer \(Windows 10\)](#)
- [Listening to music from a device connected via BLUETOOTH](#)
- [Disconnecting BLUETOOTH connection \(after use\)](#)

Wireless Stereo Headset
MDR-ZX220BT

Connecting to a paired computer (Windows 8/Windows 8.1)

Before starting the operation, make sure the following:

- Depending on the computer, the built-in BLUETOOTH adaptor should be turned on. For whether or not a BLUETOOTH adaptor is incorporate, and for how to turn it on, refer to the operating instructions supplied with the computer.

1 Resume the computer from sleep mode.

2 Turn on the headset.

Press and hold the  button for about 2 seconds.

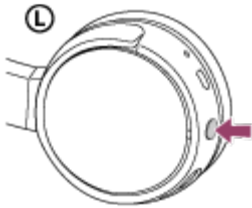

Make sure that the indicator (blue) flashes after you release the button. You hear voice guidance “Power on”.

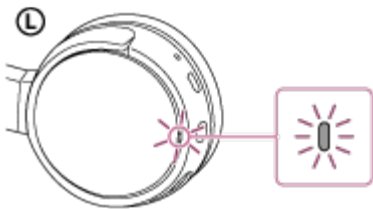

After the headset turns on, if it has automatically connected to the last connected device, you hear voice guidance “BLUETOOTH connected”.

Use the computer to check whether the connection is established, and if it is not established, proceed to step 3.

If the computer has connected to the last BLUETOOTH device connected, disconnect it, then proceed to the next step.

3 Select the headset using the computer.

1. Select [Desktop] on the Start screen.
2. Move the mouse pointer to the top-right corner of the screen (when using a touch panel, swipe from the right edge of the screen), then select [Settings] from the Charm Bar.



3. Select [Control Panel] in the [Settings] charm.
4. Select [Hardware and Sound], then [Devices and Printers].

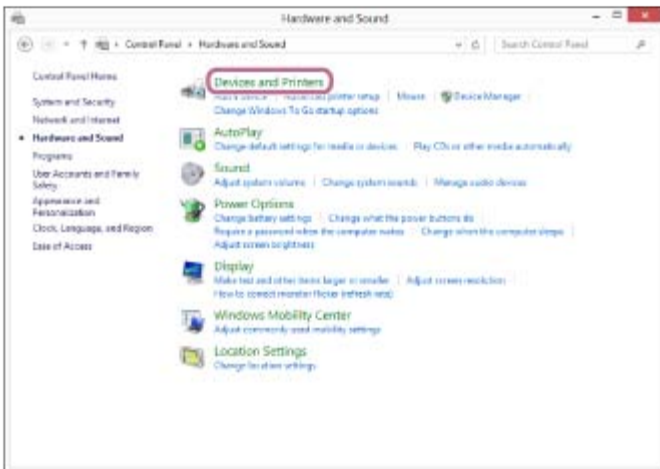
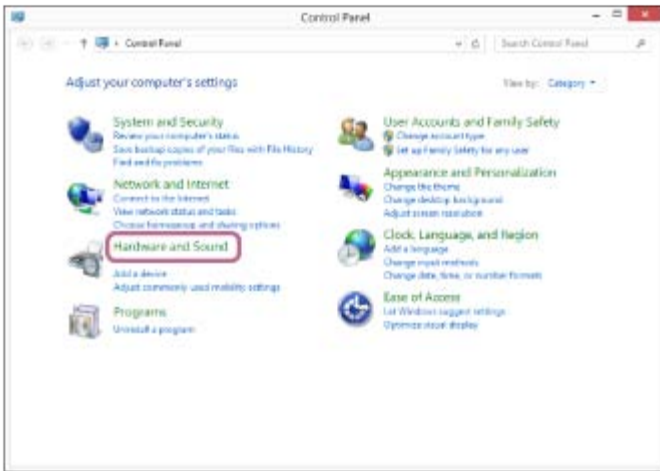

5. Right-click [MDR-ZX220BT] in the [Devices and Printers] screen.

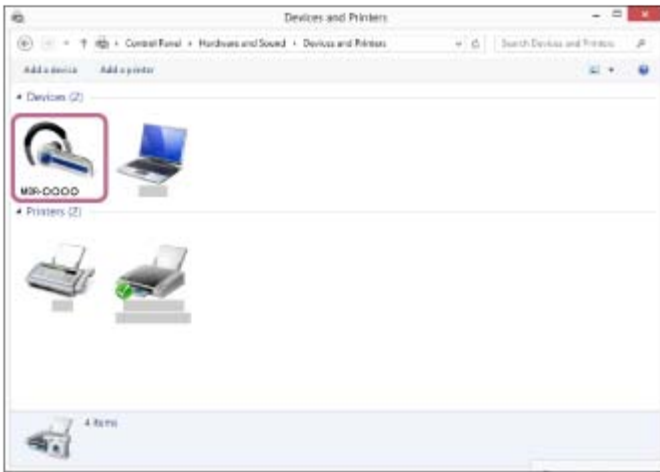

6. Select [Advanced Operation] — [Connect to audio sink device].

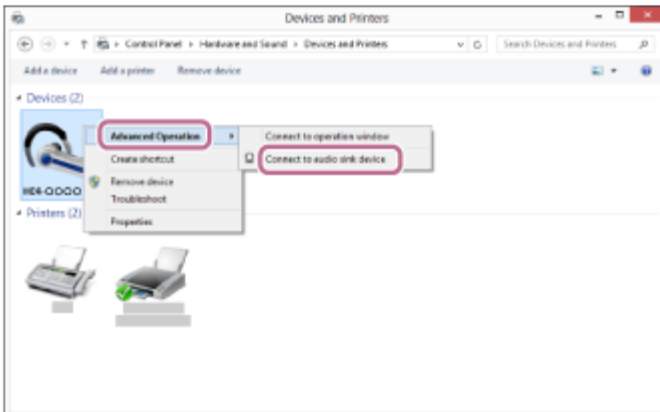

Hint

- The above procedure is an example. For details, refer to the operating instructions supplied with your computer.
- If the computer was connected with the headset the last time, an HFP/HSP connection is made when you turn on the headset. While the headset is on, you can make an A2DP connection (music playback) by pressing the ►|| button.

Note

- If the headset tries to make a connection with a previously connected BLUETOOTH device, you may not be able to connect to the device you want to. If connection fails, terminate the BLUETOOTH connection from the device that was previously connected.

Related Topic

- [How to make a wireless connection to BLUETOOTH devices](#)
- [Pairing and connecting with a computer \(Windows 8/Windows 8.1\)](#)
- [Listening to music from a device connected via BLUETOOTH](#)
- [Disconnecting BLUETOOTH connection \(after use\)](#)

Wireless Stereo Headset
MDR-ZX220BT

Connecting to a paired computer (Windows 7)

Before starting the operation, make sure the following:

- Depending on the computer, the built-in BLUETOOTH adaptor should be turned on. For whether or not a BLUETOOTH adaptor is incorporate, and for how to turn it on, refer to the operating instructions supplied with the computer.

1 Resume the computer from sleep mode.

2 Turn on the headset.

Press and hold the  button for about 2 seconds.

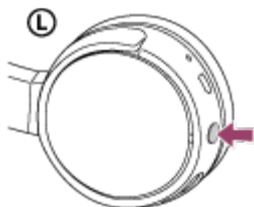

Make sure that the indicator (blue) flashes after you release the button. You hear voice guidance “Power on”.

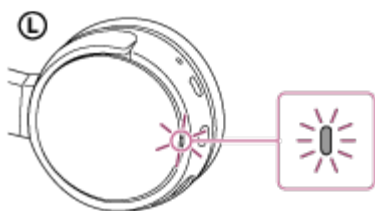

After the headset turns on, if it has automatically connected to the last connected device, you hear voice guidance “BLUETOOTH connected”.

Use the computer to check whether the connection is established, and if it is not established, proceed to step 3.

If the computer has connected to the last BLUETOOTH device connected, disconnect it, then proceed to the next step.

3 Select the headset using the computer.

1. Click the [Start] button, then [Devices and Printers].
2. Double-click [MDR-ZX220BT] of the device.



3. Click [Listen to Music].

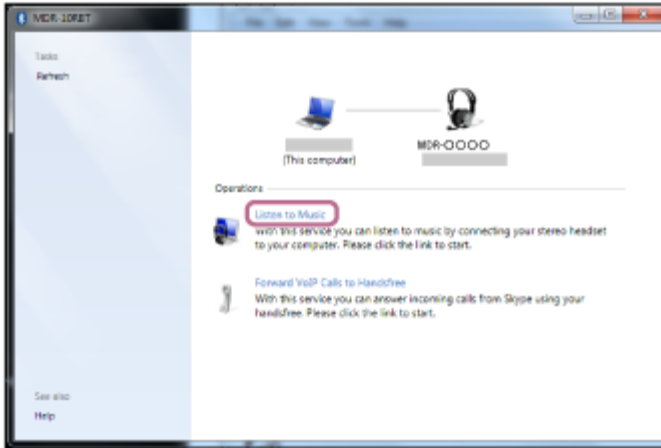

Hint

- The above procedure is an example. For details, refer to the operating instructions supplied with your computer.
- If the computer was connected with the headset the last time, an HFP/HSP connection is made when you turn on the headset. While the headset is on, you can make an A2DP connection (music playback) by pressing the ►|| button.

Note

- If the headset tries to make a connection with a previously connected BLUETOOTH device, you may not be able to connect to the device you want to. If connection fails, terminate the BLUETOOTH connection from the device that was previously connected.

Related Topic

- [How to make a wireless connection to BLUETOOTH devices](#)
- [Pairing and connecting with a computer \(Windows 7\)](#)
- [Listening to music from a device connected via BLUETOOTH](#)
- [Disconnecting BLUETOOTH connection \(after use\)](#)

Wireless Stereo Headset
MDR-ZX220BT

Connecting to a paired computer (Windows Vista)

Before starting the operation, make sure the following:

- Depending on the computer, the built-in BLUETOOTH adaptor should be turned on. For whether or not a BLUETOOTH adaptor is incorporate, and for how to turn it on, refer to the operating instructions supplied with the computer.

1 Resume the computer from sleep mode.

2 Turn on the headset.

Press and hold the  button for about 2 seconds.

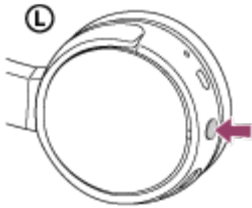

Make sure that the indicator (blue) flashes after you release the button. You hear voice guidance “Power on”.

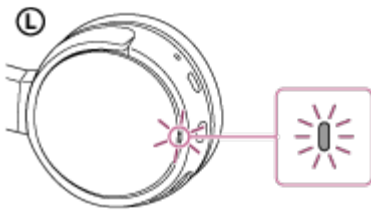

After the headset turns on, if it has automatically connected to the last connected device, you hear voice guidance “BLUETOOTH connected”.

Use the computer to check whether the connection is established, and if it is not established, proceed to step 3.

If the computer has connected to the last BLUETOOTH device connected, disconnect it, then proceed to the next step.

3 Select the headset using the computer.

1. Right-click the BLUETOOTH icon on the windows toolbar, then click [Bluetooth Settings].

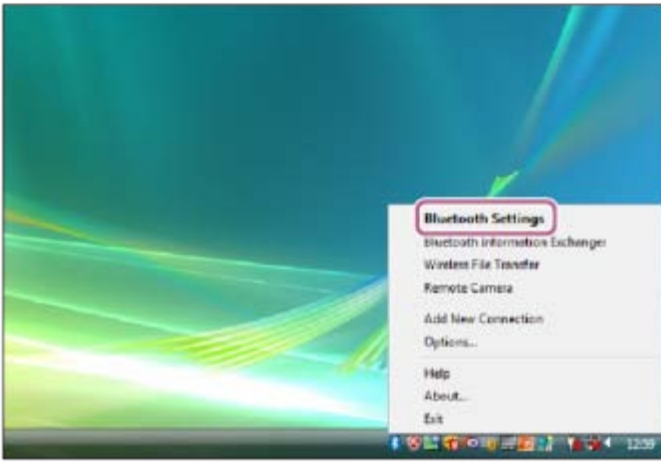

2. Double-click [MDR-ZX220BT] in the [Bluetooth Settings] screen.

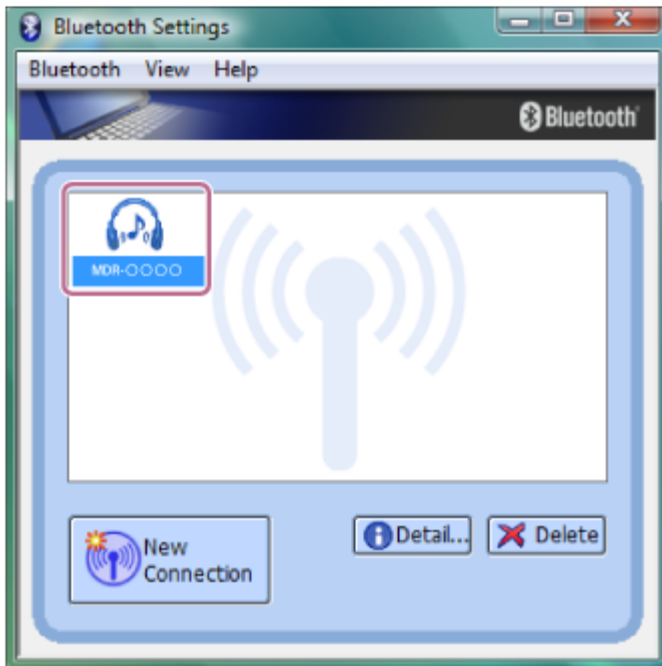

Hint

- The above procedure is an example. For details, refer to the operating instructions supplied with your computer.
- If the computer was connected with the headset the last time, an HFP/HSP connection is made when you turn on the headset. While the headset is on, you can make an A2DP connection (music playback) by pressing the ►|| button.

Note

- If the headset tries to make a connection with a previously connected BLUETOOTH device, you may not be able to connect to the device you want to. If connection fails, terminate the BLUETOOTH connection from the device that was previously connected.

Related Topic

- [How to make a wireless connection to BLUETOOTH devices](#)
- [Pairing and connecting with a computer \(Windows Vista\)](#)
- [Listening to music from a device connected via BLUETOOTH](#)
- [Disconnecting BLUETOOTH connection \(after use\)](#)

Wireless Stereo Headset
MDR-ZX220BT

Pairing and connecting with other BLUETOOTH devices

Pairing is the process required to create a link between BLUETOOTH devices to allow wireless connection. You must pair a device with the headset to be able to make a BLUETOOTH connection for the first time. Before you start pairing operation, make sure that:

- The BLUETOOTH device is placed within 1 m(3 feet) of the headset.
- The headset is charged sufficiently.
- The operating instructions of the BLUETOOTH device is on hand.

1 Enter pairing mode on this headset.

When you pair the headset with a device for the first time after you bought it, or after you initialized the headset (the headset has no pairing information), press and hold the  button for about 2 seconds when the headset is turned off. The headset enters pairing mode automatically.

When you pair a 2nd or subsequent device (the headset has pairing information for other devices), press and hold the  button for about 7 seconds.

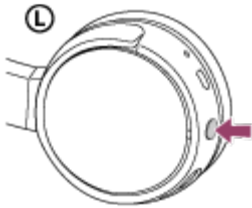

Make sure that the indicator flashes blue and red alternately after you release the button. You hear voice guidance "BLUETOOTH pairing".

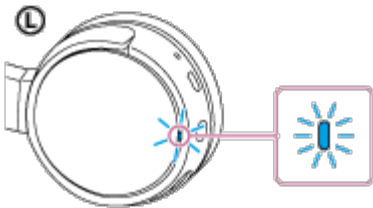

2 Perform the pairing procedure on the BLUETOOTH device to search for this headset.

[MDR-ZX220BT] will be displayed on the list of detected devices on the screen of the BLUETOOTH device. If not displayed, repeat from step 1.

3 Select [MDR-ZX220BT].

If passkey (*) input is required on the display of the BLUETOOTH device, input "0000."

* A Passkey may be called a “Passcode,” a “PIN code,” or a “Password.”

4 Make the BLUETOOTH connection from the BLUETOOTH device.

Depending on the BLUETOOTH device, the headset may be connected with the device automatically as soon as they are paired.

When connected, you hear voice guidance “BLUETOOTH connected”.

Note

- If pairing is not established within about 5 minutes, pairing mode will be canceled and the headset will turn off. In this case, start over from step 1.
- When pairing with a BLUETOOTH device that cannot display a list of detected devices or that has no display, you may pair the device by setting both the headset and the BLUETOOTH device to pairing mode. At this time, if passkey is set other than “0000” on the BLUETOOTH device, pairing cannot be done with the headset.
- Once BLUETOOTH devices are paired, there is no need to pair them again, except in the following cases:
 - Pairing information has been deleted after repair, etc.
 - The headset is already paired with 8 devices and another device is to be paired.
The headset can be paired with up to 8 devices. If a new device is paired after 8 devices are already paired, the paired device with the oldest connection time is replaced by the new one.
 - When the pairing information for the headset has been deleted from the BLUETOOTH device.
 - When the headset is initialized, all pairing information is deleted.
In this case, delete the pairing information of the headset from the BLUETOOTH device, and then pair them again.
- The headset can be paired with multiple devices, but can only play music from one paired device at a time.

Hint

- The above procedure is an example. For details, refer to the operating instructions supplied with your BLUETOOTH device.
- To delete all pairing information, see “[Initializing the headset to restore factory settings.](#)”

Related Topic

- [How to make a wireless connection to BLUETOOTH devices](#)
- [Connecting to a paired BLUETOOTH device](#)
- [Listening to music from a device connected via BLUETOOTH](#)
- [Initializing the headset to restore factory settings](#)

Wireless Stereo Headset
MDR-ZX220BT

Connecting to a paired BLUETOOTH device

1 Turn on the headset.

Press and hold the  button for about 2 seconds.

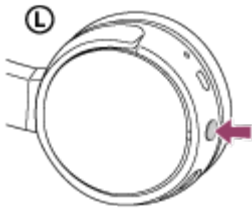

Make sure that the indicator (blue) flashes after you release the button. You hear voice guidance “Power on”.

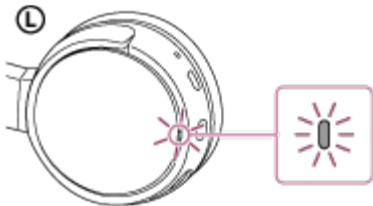

After the headset turns on, if it has automatically connected to the last connected device, you hear voice guidance “BLUETOOTH connected”.

Check the connection status on the BLUETOOTH device. If not connected, proceed to step 2.

2 Make the BLUETOOTH connection from the BLUETOOTH device.

For details, refer to the operating instructions supplied with your BLUETOOTH device.

When connected, you hear voice guidance “BLUETOOTH connected”.

Hint

- The above procedure is an example. For details, refer to the operating instructions supplied with your BLUETOOTH device.
- If the BLUETOOTH device was connected with the headset the last time, an HFP/HSP connection is made when you turn on the headset. While the headset is on, you can make an A2DP connection (music playback) by pressing the  button.

Note

- If the headset tries to make a connection with a previously connected BLUETOOTH device, you may not be able to connect to the device you want to. If connection fails, terminate the BLUETOOTH connection from the device that was previously connected.

Related Topic

- [How to make a wireless connection to BLUETOOTH devices](#)
- [Pairing and connecting with other BLUETOOTH devices](#)
- [Listening to music from a device connected via BLUETOOTH](#)

Wireless Stereo Headset
MDR-ZX220BT

Connecting the headset to both a music player and a smartphone or mobile phone

To use a BLUETOOTH music player for listening to music and a BLUETOOTH smartphone for making phone calls, the headset needs to be connected with each device with a BLUETOOTH connection.

- 1 Pair the headset with BLUETOOTH devices, respectively.
- 2 Make an A2DP BLUETOOTH connection between the headset and the BLUETOOTH music player.
- 3 Make an HFP or HSP BLUETOOTH connection between the headset and the BLUETOOTH smartphone or mobile phone.

Note

- If the smartphone or mobile phone was connected with the headset the last time, an HFP or HSP connection is made automatically when you turn on the headset. At the same time, an A2DP connection may also be made automatically. If this happens, disconnect the headset from the smartphone or mobile phone once using the phone, then connect the devices again by repeating the process from step 2.

Wireless Stereo Headset
MDR-ZX220BT

Connecting the headset to 2 Android smartphones

When you connect the headset to a smartphone, usually the music playback function and the phone call function are both connected automatically.

To make a multi point connection with 2 smartphones separately, one for listening to music and the other for making phone calls, change the settings of the smartphones so that only one of the functions is connected for each smartphone.

- 1 Pair the headset with both smartphones, respectively.
- 2 Use one of the smartphones to establish a BLUETOOTH connection with the headset.
- 3 On the smartphone connected to the headset, uncheck either [Phone audio] (HFP) or [Media audio] (A2DP).

Example: To connect "Media audio" (A2DP) only

Touch [Settings] - [Bluetooth] - the setting icon next to [MDR-ZX220BT].



On the [Paired Bluetooth device] screen, uncheck [Phone audio].

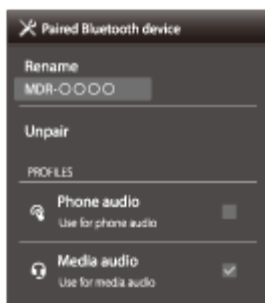

- 4 Terminate the BLUETOOTH connection of the smartphone.

5 Use the other smartphone to establish a BLUETOOTH connection to the headset.

6 In the same way, uncheck the function that you did not uncheck in step 3.

7 Use the first smartphone to establish a BLUETOOTH connection again.

Both smartphones are connected to the headset with only one function enabled.

Hint

- The above procedure is an example. For details, refer to the operating instructions supplied with your Android smartphones.

Wireless Stereo Headset
MDR-ZX220BT

Connecting the headset to an Android smartphone and an iPhone

When you connect the headset to a smartphone, usually the music playback function and the phone call function are both connected automatically. To make a multi point connection using an Android smartphone and an iPhone separately for listening to music and making phone calls, change the settings on the Android smartphone so that only one of the functions is connected. Connect the Android smartphone first, and then connect the iPhone.

You cannot set the iPhone to connect one function only.

- 1 Pair the headset with both Android smartphone and iPhone, respectively.
- 2 Use the Android smartphone to establish a BLUETOOTH connection with the headset.
- 3 On the Android smartphone connected to the headset, uncheck either [Phone audio] (HFP) or [Media audio] (A2DP).

Example: To connect "Media audio" (A2DP) only

Touch [Settings] - [Bluetooth] - the setting icon next to [MDR-ZX220BT].



On the [Paired Bluetooth device] screen, uncheck [Phone audio].

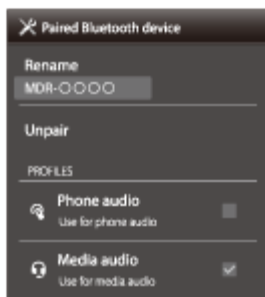

4 Use the iPhone to establish a BLUETOOTH connection to the headset.

The iPhone is connected to the headset with both functions, but you can only use the function that you unchecked in step 3.

Hint

- The above procedure is an example. For details, refer to the operating instructions supplied with your Android smartphone.

Note

- If you connect an Android smartphone with [Phone audio] (HFP), the remaining battery charge of the headset will not be displayed correctly on an iPhone.

Wireless Stereo Headset
MDR-ZX220BT

Listening to music from a device connected via BLUETOOTH

You can enjoy listening to music and basic remote control operation of a BLUETOOTH device via a BLUETOOTH connection. The BLUETOOTH device is required to support the following BLUETOOTH profiles.

- A2DP (Advanced Audio Distribution Profile):
enables you to enjoy high-quality audio content wirelessly.
- AVRCP (Audio Video Remote Control Profile):
enables you to adjust volume, etc.

The operation may vary depending on the BLUETOOTH device. Refer to the operating instructions supplied with your BLUETOOTH device.

1 Connect the headset to a BLUETOOTH device.

2 Wear the headset.

Adjust the length of the headband.

Put the headset with **L** indication on your left ear and **R** indication on your right ear. The **L** unit of the headset has a tactile dot.

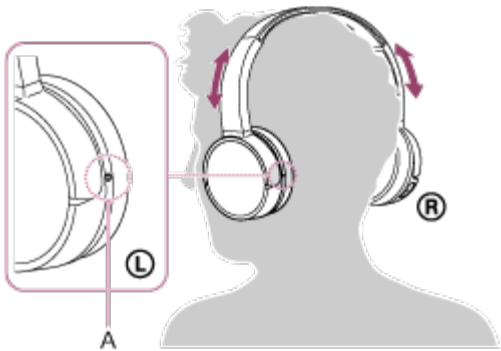

A: Tactile dot

3 Play back music or video on the BLUETOOTH device.

Adjust the volume on the BLUETOOTH device.

4 Adjust the volume by pressing the +/- buttons of the headset.

When the volume reaches the maximum or minimum, an alarm sounds.

Note

- If the communication condition is poor, the BLUETOOTH device may react incorrectly to the operation on the headset.

Hint

- The headset supports SCMS-T content protection. You can enjoy music, etc., from a device such as a mobile phone or portable TV that supports SCMS-T content protection.
- Depending on the BLUETOOTH device, it may be necessary to adjust the volume or set the audio output setting on the BLUETOOTH device.
- Volume during a call and volume during music playback can be adjusted independently. Changing the call volume does not change the volume of music playback, and vice versa.

Related Topic

- [How to make a wireless connection to BLUETOOTH devices](#)
- [Controlling the audio device \(BLUETOOTH connection\)](#)

Wireless Stereo Headset
MDR-ZX220BT

Controlling the audio device (BLUETOOTH connection)

If the BLUETOOTH device supports AVRCP, you can control it by the headset. The functions available may vary depending on the BLUETOOTH device. Refer to the operating instructions supplied with your BLUETOOTH device.

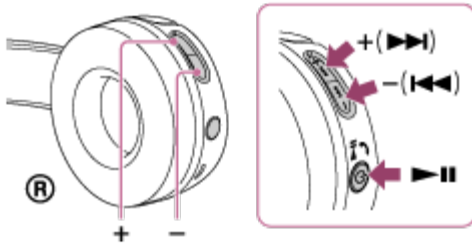

Each button has the following function:

▶ ||:

- Press once during pause to start playback.
- Press once during playback to pause.

+/-/◀◀ / ▶▶:

- Press to adjust the volume.
- Press and hold until you hear a beep to skip to the beginning of the next track/beginning of the previous (or current) track. After releasing the button, press within 1 second to skip to the beginning of the next/previous track and hear a beep (you can repeat this operation).

Note

- If the communication condition is poor, the BLUETOOTH device may react incorrectly to the operation on the headset.
- The available functions may vary depending on the BLUETOOTH device. When you operate as illustrated above, it may operate differently or may not work at all.

Wireless Stereo Headset
MDR-ZX220BT

Disconnecting BLUETOOTH connection (after use)

- 1 If using a device that supports one-touch connection (NFC), touch the device to the headset again. (Unlock the screen of the device if it is locked.) If using a device that does not support one-touch connection (NFC), operate from the BLUETOOTH device.

When disconnected, you hear voice guidance "BLUETOOTH disconnected".

- 2 Press and hold the  button on the headset for about 2 seconds to turn off the headset. You hear voice guidance "Power off".

Hint

- When you finish playing music, the BLUETOOTH connection may terminate automatically, depending on the BLUETOOTH device.

Wireless Stereo Headset
MDR-ZX220BT

Supported codecs

A codec is an audio coding algorithm used when transmitting sound via a BLUETOOTH connection.

The headset supports the following 2 codecs for music playback via an A2DP connection: SBC and AAC.

- SBC
This is an abbreviation for Subband Codec.
This is the standard audio coding technology used by BLUETOOTH devices.
All BLUETOOTH devices support SBC.
- AAC
This is an abbreviation for Advanced Audio Coding.
AAC is mainly used by Apple products such as iPhones, and it provides higher sound quality than that of SBC.

When music in one of the above codecs is transmitted from a connected device, the headset switches to that codec automatically and plays back the music in the same codec.

However, depending on the device to be connected with the headset, you may need to set the device beforehand to listen to music in a different codec on the headset, even if the device supports a codec of higher sound quality than SBC.

Refer to the operating instructions supplied with the device regarding setting the codec.

Wireless Stereo Headset
MDR-ZX220BT

Receiving a call

You can enjoy a hands-free call with a smartphone or mobile phone that supports the BLUETOOTH profile HFP (Hands-free Profile) or HSP (Headset Profile), via a BLUETOOTH connection.

- If your smartphone or mobile phone supports both HFP and HSP, set it to HFP.
- Operations may vary depending on the smartphone or mobile phone. Refer to the operating instructions supplied with your smartphone or mobile phone.

Ring tone

When an incoming call arrives, a ring tone will be heard from the headset, and the indicator (blue) flashes quickly. You will hear either of following ring tones, depending on your smartphone or mobile phone.

- Ring tone set on the headset
- Ring tone set on the smartphone or mobile phone
- Ring tone set on the smartphone or mobile phone only for a BLUETOOTH connection

1 Connect the headset to a smartphone or mobile phone beforehand.

2 When you hear a ring tone, press  button on the headset and receive the call.

When an incoming call arrives even while you are listening to music, playback pauses and a ring tone will be heard from the headset.

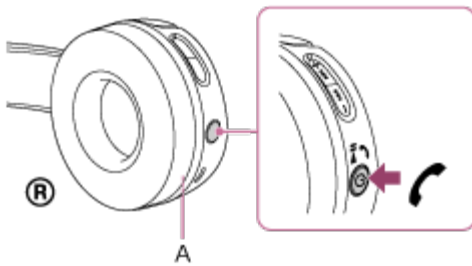

A: Microphone

If no ring tone is heard via the headset

- The headset may not be connected with the smartphone or mobile phone with HFP or HSP. Check the connection status on the smartphone or mobile phone.
- If playback does not pause automatically, operate the headset to pause playback.

3 Press the + or - button to adjust the volume.

When the volume reaches the maximum or minimum, an alarm sounds.

4 To end the call, press the  button on the headset again.

If you received a call during music playback, music playback resumes automatically.

Note

- Depending on the smartphone or mobile phone, playback may not resume automatically even if you finish the call.
- Use a smartphone or mobile phone at least 50 cm(19 3/4 in.) away from the headset. Noise may result if the headset and the smartphone or mobile phone are too close.

Hint

- Some smartphones or mobile phones by default receive calls with the phone instead of the headset. With an HFP or HSP connection, switch the call device to the headset by holding the  button down for about 2 seconds or by using your smartphone or mobile phone.
- If you adjust the volume on the headset when not talking, the music playback volume is adjusted.
- Volume during a call and volume during music playback can be adjusted independently. Changing the call volume does not change the volume of music playback, and vice versa.

Related Topic

- [How to make a wireless connection to BLUETOOTH devices](#)
- [Making a call](#)
- [Functions for a phone call](#)

Wireless Stereo Headset
MDR-ZX220BT

Making a call

You can enjoy a hands-free call with a smartphone or mobile phone that supports the BLUETOOTH profile HFP (Hands-free Profile) or HSP (Headset Profile), via a BLUETOOTH connection.

- If your smartphone or mobile phone supports both HFP and HSP, set it to HFP.
- Operations may vary depending on the smartphone or mobile phone. Refer to the operating instructions supplied with your smartphone or mobile phone.

1 Connect the headset to a smartphone or mobile phone beforehand.

2 Operate your smartphone or mobile phone to make a call.

When you make a call, the dial tone is heard from the headset.

If you make a call while you are listening to music, playback pauses.

If no dial tone is heard via the headset, switch the call device to the headset using your smartphone or mobile phone or by holding the  button down for about 2 seconds.

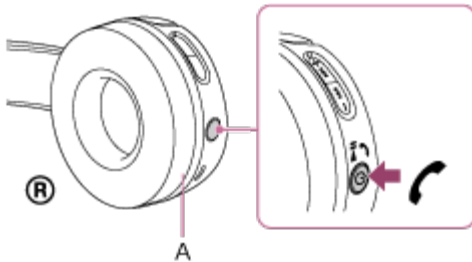

A: Microphone

3 Press the + or - button to adjust the volume.

When the volume reaches the maximum or minimum, an alarm sounds.

4 To end the call, press the  button on the headset again.

If you made a call during music playback, music playback resumes automatically.

Note

- Use a smartphone or mobile phone at least 50 cm(19 3/4 in.) away from the headset. Noise may result if the headset and the smartphone or mobile phone are too close.

Hint

- Volume for a call can be adjusted during a telephone conversation only.
- Volume for a call and listening to music can be adjusted independently. Even if you change the volume while playing back music, the volume of a call does not change.

Related Topic

- [How to make a wireless connection to BLUETOOTH devices](#)
- [Receiving a call](#)
- [Functions for a phone call](#)

Wireless Stereo Headset
MDR-ZX220BT



Functions for a phone call

The available functions may vary depending on the profile supported by your smartphone or mobile phone. Even if the profile is the same, functions may vary depending on the smartphone or mobile phone.



Refer to the operating instructions supplied with your smartphone or mobile phone.

Supported profile: HFP



Outgoing call

- Press the  button once to cancel an outgoing call.
- Press the  button for about 2 seconds to change the call device between the headset and the smartphone or mobile phone.

Incoming call

- Press the  button once to answer a call.
- Press and hold the  button for about 2 seconds to reject a call.

During call

- Press the  button once to finish a call.
- Press the  button for about 2 seconds to change the call device between the headset and the smartphone or mobile phone.

Supported profile: HSP

Outgoing call

- Press the  button once to cancel an outgoing call. (*)

Incoming call

- Press the  button once to answer a call.

During call

- Press the  button once to finish a call. (*)

* Some devices may not support this function.

Related Topic

- [Receiving a call](#)
- [Making a call](#)

Wireless Stereo Headset
MDR-ZX220BT

Precautions

Note on static electricity

- Static electricity accumulated in the body may cause mild tingling in your ears. To minimize the effect, wear clothes made from natural materials.

Others

- Do not place this headset in a place exposed to humidity, dust, soot or steam, or subject to direct sunlight. Do not leave the headset in a car for a long time. It may cause a malfunction.
- Using the BLUETOOTH device may not function on mobile phones, depending on radio wave conditions and location where the device is being used.
- Listening with this headset at high volume may affect your hearing. For traffic safety, do not use this headset while driving or cycling.
- Do not use the headset in places where it would be dangerous if you are unable to hear ambient sound, such as at railroad crossings, train station platforms, pedestrian crossings, and construction sites.
- Do not put weight or pressure on this headset as it may cause the headset to deform during long storage.
- Do not subject the headset to excessive shock.
- Clean the headset with a soft dry cloth.
- Do not expose the headset to water. The headset is not waterproof. Remember to follow the precautions below.
 - Be careful not to drop the headset into a sink or other container filled with water.
 - Do not use the headset in humid locations or bad weather, such as in the rain or snow.
 - Do not get the headset wet. If you touch the headset with wet hands, or put the headset in a damp article of clothing, the headset may get wet and this may cause a malfunction of the headset.
- If you experience discomfort after using the BLUETOOTH device, stop using the BLUETOOTH device immediately. Should any problem persist, consult your nearest Sony dealer.
- The earpads may deteriorate due to long-term storage or use.
- Optional replacement earpads can be ordered from your nearest Sony dealer.
- If you have any questions or problems concerning this headset that are not covered in this manual, please consult your nearest Sony dealer.

Wireless Stereo Headset
MDR-ZX220BT

What is BLUETOOTH wireless technology?

BLUETOOTH wireless technology is a short-range wireless technology that enables wireless data communication between digital devices, such as a computer and digital camera. BLUETOOTH wireless technology operates within a range of about 10 m(30 feet).

Connecting two devices as necessary is common, but some devices can be connected to multiple devices at the same time. You do not need to use a cable for connection, nor is it necessary for the devices to face one another, such is the case with infrared technology. For example, you can use such a device in a bag or pocket.

BLUETOOTH is an international standard supported by thousands of companies worldwide.

Communication system and compatible BLUETOOTH profiles of the unit

Profile is standardization of the function for each BLUETOOTH device specification. The unit supports the following BLUETOOTH version and profiles:

Communication system:

BLUETOOTH Specification Ver. 4.1

Compatible BLUETOOTH profiles:

- A2DP (Advanced Audio Distribution Profile): Transmitting or receiving audio content of high-quality.
- AVRCP (Audio Video Remote Control Profile): Controlling A/V equipment; pausing, stopping, starting playback, etc.
- HSP (Headset Profile)(*): Talking on the phone/Operating the phone.
- HFP (Hands-free Profile)(*): Talking on the phone/Operating the phone by hands-free.

* When you use a BLUETOOTH mobile phone supported by both HFP (Hands-free Profile) and HSP (Headset Profile), set it to HFP.

Maximum communication range

Use the devices within a range of about 10 m(30 feet) of line of sight.

Maximum communication range may shorten under the following conditions.

- There is an obstacle such as a person, metal, or wall between this unit and the BLUETOOTH device.
- A Wi-Fi device is in use near this unit.
- A microwave oven is in use near this unit.
- A device that generates electromagnetic radiation is in use near this unit.

Interference from other devices

Because BLUETOOTH uses 2.4 GHz, the same frequency as some Wi-Fi (IEEE802.11b/g/n), a Wi-Fi device used nearby may cause interference: resulting in noise, an invalid connection, or deterioration of communication speed. In such a case, perform the following.

- Use this unit at least 10 m(30 feet) away from the Wi-Fi device.
- If this unit is used within 10 m(30 feet) of a Wi-Fi device, turn off the Wi-Fi device.
- Bring the headset and the BLUETOOTH device closer together.

Interference to other devices

Microwaves emitting from a BLUETOOTH device may affect the operation of electronic medical devices. Turn off this unit and other BLUETOOTH devices in the following locations, as it may cause an accident.

- where inflammable gas is present, in a hospital, train, airplane, or a gas station
- near automatic doors or a fire alarm

Note

- To be able to use the BLUETOOTH function, the BLUETOOTH device to be connected requires the same profile as this unit. Note also that even if the same profile exists, devices may vary in function depending on their specifications.
- Due to the characteristic of BLUETOOTH wireless technology, the sound played on this unit is slightly delayed from the sound played on the BLUETOOTH device during talking on the telephone or listening to the music.
- This unit supports security capabilities that comply with the BLUETOOTH standard to provide a secure connection when the BLUETOOTH wireless technology is used, but security may not be enough depending on the setting. Be careful when communicating using BLUETOOTH wireless technology.
- We do not take any responsibility for the leakage of information during BLUETOOTH communication.
- A device featuring the BLUETOOTH function is required to conform to the BLUETOOTH standard specified by Bluetooth SIG, Inc. and be authenticated. Even if the connected device conforms to the above mentioned BLUETOOTH standard, some devices may not be connected or work correctly, depending on the features or specifications of the device.
- Noise or sound skips may occur depending on the BLUETOOTH device connected with this unit, the communication environment or the usage environment.

Wireless Stereo Headset
MDR-ZX220BT

Trademarks

- The BLUETOOTH word mark and logos are owned by the Bluetooth SIG, Inc. and any use of such marks by Sony Corporation is under license.
- The N-Mark is a trademark or registered trademark of NFC Forum, Inc. in the United States and in other countries.
- Android and Google Play are trademarks of Google Inc.
- iPad, iPhone, iPod touch are trademarks of Apple Inc., registered in the U.S. and other countries.
- Microsoft, Windows and Windows Vista are registered trademarks or trademarks of Microsoft Corporation in the United States and/or other countries.
- Mac and Mac OS are trademarks of Apple Inc., registered in the U.S. and other countries.

Other trademarks and trade names are those of their respective owners.

Wireless Stereo Headset
MDR-ZX220BT

Customer support websites

Please access the following support website to get the support information about your headset:

For customers in the U.S.A:

<http://esupport.sony.com/>

For customers in Canada:

<http://esupport.sony.com/CA/>

For customers in Latin America:

<http://esupport.sony.com/LA/>

For customers in European countries:

www.sony.eu/support

For customers in other countries/regions:

<http://www.sony-asia.com/>

Wireless Stereo Headset
MDR-ZX220BT

What can I do to solve a problem?

If the headset does not function as expected, try the following steps to resolve the issue.

- Find the symptoms of the issue in this Help Guide, and try any corrective actions listed.
- Connect the headset to a computer to charge the battery.
You may be able to resolve some issues by charging the battery.
- Reset the headset.
- Initialize the headset.
This operation resets volume settings, etc., and deletes all pairing information.
- Look up information on the issue on the customer support website.

If the operations above do not work, consult your nearest Sony dealer.

Related Topic

- [Charging the headset](#)
- [Customer support websites](#)
- [Resetting the headset](#)
- [Initializing the headset to restore factory settings](#)

Wireless Stereo Headset
MDR-ZX220BT

The headset is not turned on.

- Charge the battery of the headset.
 - The headset cannot be turned on while charging the battery. Remove the micro-USB cable from the headset, and then turn on the headset again.
-

Related Topic

- [Charging the headset](#)
- [Checking the remaining battery charge](#)

Wireless Stereo Headset
MDR-ZX220BT

Charging cannot be done.

- Check that you are using the micro-USB cable supplied.
 - Check that the micro-USB cable is connected to the headset and the computer firmly.
 - Check that the computer is turned on.
 - Check that the computer is not in standby, sleep or hibernation mode.
 - When using Windows 8.1 update using Windows Update.
-

Related Topic

- [Charging the headset](#)

Wireless Stereo Headset
MDR-ZX220BT

Charging time is too long.

- Check that the headset and the computer are directly connected, not via a USB hub.
-

Related Topic

- [Charging the headset](#)

Wireless Stereo Headset
MDR-ZX220BT

The headset cannot be recognized by a computer.

-
- The micro-USB cable is not connected properly to the USB port of the computer. Connect the micro-USB cable again.
 - Check that the headset and the computer are directly connected, not via a USB hub.
 - A problem may have occurred with the connected USB port of the computer. Connect to another USB port if it is available.
 - Try the USB connection procedure again in cases other than those stated above.
 - Check that you are using the micro-USB cable supplied.

Wireless Stereo Headset
MDR-ZX220BT

The remaining battery charge of the headset is not displayed on the screen of an iPhone, iPad, or iPod touch.

-
- The remaining battery charge is shown only on the screen of an iPhone, iPad, or iPod touch (iOS 5.0 or later) that supports HFP (Hands-free Profile).
 - Make sure that the iPhone, iPad or iPod touch is connected with HFP (Hands-free Profile). Otherwise, the remaining battery charge will not be displayed correctly.

Wireless Stereo Headset
MDR-ZX220BT

No sound

- Check that both the headset and the connected device (i.e., smartphone) are turned on.
 - An A2DP BLUETOOTH connection is not made between the headset and the BLUETOOTH device. Use the BLUETOOTH device and make an A2DP BLUETOOTH connection.
 - Turn up the volume of the headset and the connected device (i.e., smartphone).
 - Check that the connected device is playing back.
 - If you are connecting a computer to the headset, make sure the audio output setting of the computer is set for a BLUETOOTH device.
 - Pair the headset and the BLUETOOTH device again.
-

Related Topic

- [How to make a wireless connection to BLUETOOTH devices](#)
- [Listening to music from a device connected via BLUETOOTH](#)

Wireless Stereo Headset
MDR-ZX220BT

Low sound level

- Turn up the volume of the headset and the connected device.

Wireless Stereo Headset
MDR-ZX220BT

Low sound quality

- Turn down the volume of the connected device.
- Keep the headset away from a microwave oven, Wi-Fi device, etc.
- Bring the headset and the BLUETOOTH device closer together. Remove any obstacles between the headset and the BLUETOOTH device.
- Keep the headset away from a TV.
- Switch the BLUETOOTH connection to A2DP by operating the BLUETOOTH device when HFP or HSP is set.
- If you connect a device with a built-in radio or tuner to the headset, broadcasts may not be received, or sensitivity may be reduced. Locate the headset farther away from the device and check that you can listen to the broadcasts satisfactorily.
- If you have previously connected the headset to this BLUETOOTH device, only an HFP/HSP BLUETOOTH connection may be made when the headset is turned on. If this happens, use the BLUETOOTH device and make an A2DP BLUETOOTH connection.
- When you listen to music from a computer on the headset, sound quality may be poor for the first few seconds after a connection is made. This is caused by the computer transmitting music at sound quality for communications at first, and it is not a malfunction.
If the sound quality does not improve after a few seconds, press the ►|| button on the headset once during playback. Or, operate the computer to make an A2DP connection. Refer to the operating instructions supplied with your computer for computer operation.

Wireless Stereo Headset
MDR-ZX220BT

Sound skips frequently during playback.

- Remove any obstacles between the antenna of the BLUETOOTH device to be connected and the built-in antenna of the headset. The antenna of the headset is built into the part shown in the dotted line below.



A: Location of the built-in antenna

- BLUETOOTH communications may be disabled, or noise or audio dropout may occur under the following conditions.
 - There is a human body between the headset and the BLUETOOTH device. This situation may be improved by placing the BLUETOOTH device facing the antenna of the headset.
 - There is an obstacle, such as metal or wall, between the headset and the BLUETOOTH device.
 - A device using 2.4 GHz frequency, such as a Wi-Fi device, cordless telephone, or microwave oven, is in use near this headset.
- The situation may be improved by changing the wireless playback quality settings or fixing the wireless playback mode to SBC on the transmitting device. For details, refer to the operating instructions supplied with the transmitting device.

Wireless Stereo Headset
MDR-ZX220BT

Pairing cannot be done.

- Bring the headset and the BLUETOOTH device within 1 m(3 feet) from each other.
 - When you turn on the headset for the first time after purchasing, initializing, or repairing it, the headset enters pairing mode automatically. Pair the headset with a BLUETOOTH device. When you want to pair a 2nd or subsequent device, press and hold the  button of the headset for about 7 seconds to enter pairing mode.
 - When you pair the headset with devices again after initializing or repairing the headset, information for pairing with the headset remaining on the iPhone or other device may prevent you from pairing them successfully. In this case, delete the pairing information of the headset from the device, and then pair them again.
-

Related Topic

- [About the indicator](#)
- [How to make a wireless connection to BLUETOOTH devices](#)
- [Initializing the headset to restore factory settings](#)

Wireless Stereo Headset
MDR-ZX220BT

Unable to connect the headset to a BLUETOOTH device with one-touch connection (NFC)

- Keep the smartphone close to the headset until the smartphone reacts. If you fail to connect, move the smartphone slowly on the N-Mark of the headset.
 - Check that the NFC function of the smartphone is set to on.
 - If the smartphone is in a case, remove it.
 - NFC reception sensitivity varies depending on the device. If you repeatedly fail to connect the headset with a smartphone by one touch, connect it to the headset by on-screen operation on the smartphone.
 - You cannot make a one-touch connection (NFC) while charging the battery because the headset cannot be turned on. Finish charging first, and then make the one-touch connection (NFC).
 - You are using a smartphone with Android 2.3.3 up to Android 4.0.4, but has not installed the one-touch connection app "NFC Easy Connect."
-

Related Topic

- [One-touch connection \(NFC\) with a smartphone \(Android 4.1 or later\)](#)
- [One-touch connection \(NFC\) with a smartphone \(Android 2.3.3 or later, and less than Android 4.1\)](#)

Wireless Stereo Headset
MDR-ZX220BT

Unable to make a BLUETOOTH connection

- Check that the headset is turned on.
 - Check that the BLUETOOTH device is turned on and the BLUETOOTH function is on.
 - Connection with the BLUETOOTH device may not be memorized on the headset. Make a BLUETOOTH connection from the BLUETOOTH device to the headset soon after pairing is complete.
 - The BLUETOOTH device is in sleep mode.
 - The BLUETOOTH connection is terminated. Make the BLUETOOTH connection again.
-

Related Topic

- [About the indicator](#)
- [How to make a wireless connection to BLUETOOTH devices](#)

Wireless Stereo Headset
MDR-ZX220BT

Distorted sound

- Keep the headset away from a microwave oven, Wi-Fi device, etc.

Wireless Stereo Headset
MDR-ZX220BT

The BLUETOOTH wireless communication range is short, or the sound skips.

- Remove any obstacles between the antenna of the BLUETOOTH device to be connected and the built-in antenna of the headset. The antenna of the headset is built into the part shown in the dotted line below.



A: Location of the built-in antenna

- BLUETOOTH communications may be disabled, or noise or audio dropout may occur under the following conditions.
 - There is a human body between the headset and the BLUETOOTH device. This situation may be improved by placing the BLUETOOTH device facing the antenna of the headset.
 - There is an obstacle, such as metal or wall, between the headset and the BLUETOOTH device.
 - A device using 2.4 GHz frequency, such as a Wi-Fi device, cordless telephone, or microwave oven, is in use near this headset.
- The situation may be improved by changing the wireless playback quality settings or fixing the wireless playback mode to SBC on the transmitting device. For details, refer to the operating instructions supplied with the transmitting device.

Wireless Stereo Headset
MDR-ZX220BT

The headset does not operate properly.

- Reset the headset. Pairing information is not deleted by this operation.
 - If you cannot use the headset even after resetting it, initialize the headset.
-

Related Topic

- [Resetting the headset](#)
- [Initializing the headset to restore factory settings](#)

Wireless Stereo Headset
MDR-ZX220BT

No voice from callers

- Check that both the headset and the connected device (i.e., smartphone) are turned on.
 - Turn up the volume of the headset and the connected device (i.e., smartphone).
 - Check that output of the BLUETOOTH device is set for the headset.
 - Select an HFP or HSP BLUETOOTH connection by operating the BLUETOOTH device.
 - If you are listening to music using the headset, stop playback, press the  button on the headset and talk.
-

Related Topic

- [How to make a wireless connection to BLUETOOTH devices](#)
- [Receiving a call](#)
- [Making a call](#)

Wireless Stereo Headset
MDR-ZX220BT

Low voice from callers

- Turn up the volume of the headset and the connected device.

Wireless Stereo Headset
MDR-ZX220BT

Resetting the headset

If the headset cannot be turned on, or if it cannot be operated even when it is turned on, connect the headset to a booted computer using the supplied micro-USB cable, then press the  button and - button simultaneously. The headset will be reset. Pairing information is not deleted.

To charge the headset after resetting, disconnect and reconnect the micro-USB cable.

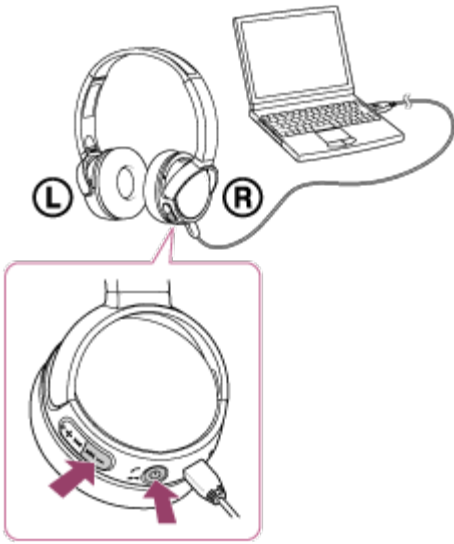

If the headset does not operate correctly even after resetting, initialize the headset to restore factory settings.

Related Topic

- [Initializing the headset to restore factory settings](#)

Wireless Stereo Headset
MDR-ZX220BT

Initializing the headset to restore factory settings

Disconnect the micro-USB cable, turn off the headset, then press and hold the  button and - button simultaneously for more than 7 seconds.

The indicator (blue) flashes 4 times () , and the headset is reset to the factory settings. All pairing information is deleted.

If the headset does not operate correctly even after initializing, consult your nearest Sony dealer.