

# ForceMaster 9000

## INSTRUCTION MANUAL

Thank you for purchasing a Shimano ForceMaster9000.

Before using this reel, please make sure you read the manual thoroughly and keep it in a safe place for future reference.



Safety Precautions	2	Automatic Gunwale Stop	41
Features	8	Alarm (Gunwale)	42
Digital Display Component Names	11	Programming Target Depth and Bottom Depth	43
Functions with Settings that Can Be Changed from the Menu	13	Finding the Target Depth	44
Part Names	15	Top-Down Mode Example	45
Power Supply   Cord	16	Bottom-Up Mode Example	46
Learning Methods(Entering the actual line length into the reel.)	17	Winding In: Rakuraku Mode   Fixed Speed Mode	47
Learning Mode	18	Manual Mode	49
Learning Methods(Inputting the actual value of the line use into the reel.)		Program Mode	50
Braided Line Learning (E1)	19	Jigging Learning	52
Nylon/Fluoro learning (E2)	21	Using the Program Mode	55
Backing Line Learning (E3)	23	Rig Retrieval Time	58
Braided Line Learning (L1)	27	Spool Free Mode	59
Backing Line Learning (L2)	29	Line Learning Adjustment	61
What to do after Completing Learning	33	Handling Instructions	64
Various Techniques		Specifications	69
(You will want to learn these techniques to improve your catch.)	36	Troubleshooting	70
Zero Setting(Always do this before you start fishing.)	37	Product Inquiries / After Sales Service Information	72
Adjusting Smart Line Depth	39	Service network	73
S A-RB	40	Memo	74

## Please read these safety precautions before using the reel.

### **Warning**



#### Caution: High Temperature

- Use only the specified voltage (DC12~24V) from a battery or the vessel's onboard power supply.  
Using voltages other than those specified may cause the reel to heat up, damage electrical components or burn your hand.
- NEVER connect the reel to a household power supply or a battery charger.  
Doing so may damage the circuit boards and cause fire and smoke.
- Stop using the reel IMMEDIATELY if the power supply connector or alligator clips become abnormally hot.

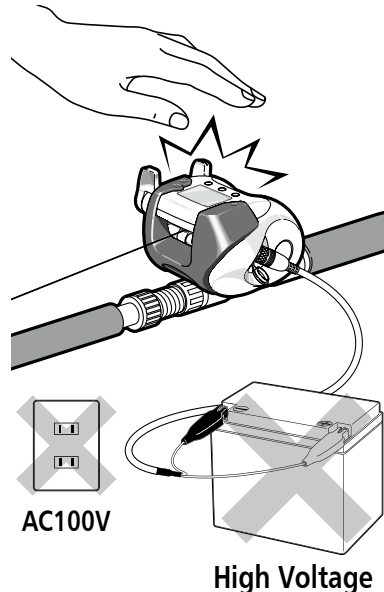

### **Warning**



#### Warning

- If the circuit breaker in the reel is tripped repeatedly, it is possible that the specifications of the reel are not appropriate for the load from that particular species of fish or rig.  
If you continue to use the reel in such a situation, the motor or display may overheat and be damaged. Should that occur, please change to a higher specification reel.



#### Warning

- If the battery mark ( **B** or  ) lights up and starts flashing, this means that battery voltage is dropping, which will lead to a decrease in performance. It also means that excessive load is being placed on the motor and display, which may cause the reel to malfunction. Stop using the reel immediately and connect to a fully charged battery.



#### Warning

- Please do NOT use the reel with a vessel's power supply or a battery that does not provide the proper voltage.  
When the battery mark ( **B** or  ) lights up and starts flashing, winding in under heavy load (high current) may damage the electronic components in the display and cause the lens to pop out.

## Warning



### Don't get your finger caught!

- Do NOT put your finger near the level winding position when fishing as it may get caught and cause injury. If your finger does become caught, turn off the power switch on the reel immediately and disassemble the reel.
- Do NOT put your finger in between the handle and the body as it may get caught and cause injury.

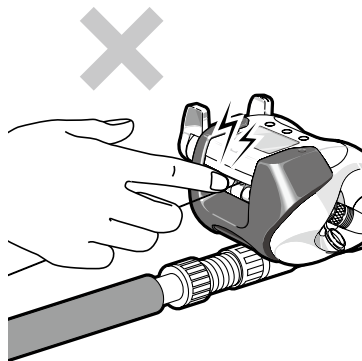

- A very weak electrical signal is produced when using the reel. This may cause medical equipment such as hearing aids and pacemakers to malfunction, causing the user to have palpitations or become dizzy.



### Warning

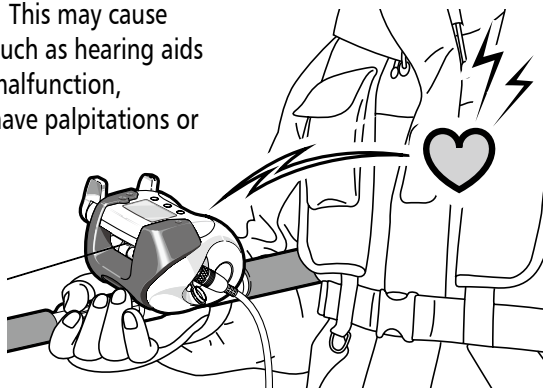

## Warning



### Warning

- Immediately remove the power cable if you see moisture or water droplets on the inside of the display. If you continue to use the reel in such a situation it may malfunction, break the tip of the rod and cause injury.
- Stop using the reel if you see a crack develop in the display or the case. If water penetrates into the case it can cause shorting to occur, which can damage the electronics and make it impossible to control the motor.

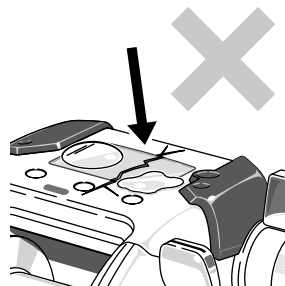

### Warning

- Stop using the reel IMMEDIATELY if a burning smell or smoke is emitted from the reel or the display, or if the reel becomes abnormally hot. If you continue to use the reel in this situation then the reel may catch fire.
- Disconnect the power connector or the alligator clips from the battery immediately if the motor cannot be stopped.

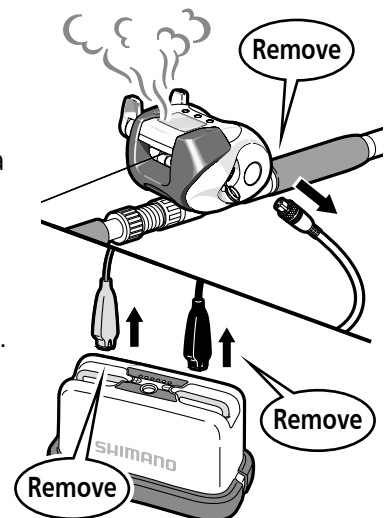



## Caution



### Caution

- When using the reel, if the display goes off, do not wind the line in manually using the handle as this will mean there will be a difference between the actual line length and the counter. If you do wind the line in manually using the handle, after the display comes back on and you start winding the line in again using the motor the gunwale stop position will be incorrect, which can cause the rig to be wound in too much and even snap off the end of the rod.

Therefore, it is important to investigate why the display has gone off and fix the problem and to only wind in the line after the display comes back on.

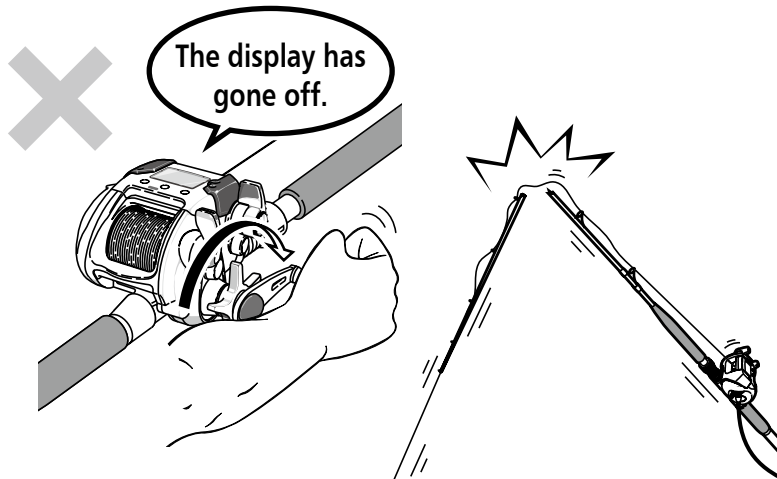

## Caution



### Caution

- If the surface of the coating on the reel comes off or if the surface of the material comes off due to a strong impact leaving a sharp edge, do NOT touch that area as it may cause injury.



### Do not get your fingers caught!

- Do NOT touch the line when it is being fed out or wound in as the line can cut or even cut off your finger.

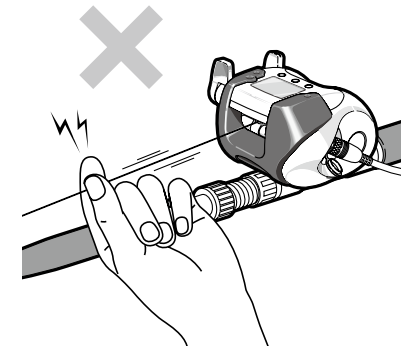

### Caution: Rotating Objects

- Do NOT touch the rotating spool as this can cause injury.

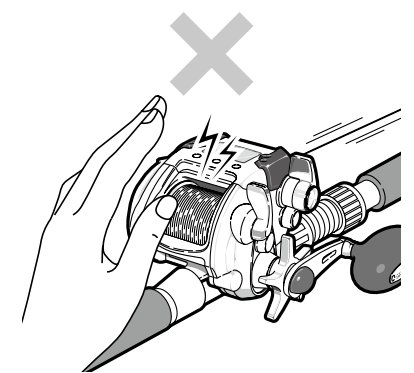





## Caution



### Caution: Rotating Objects

- Do NOT put your finger near rotating parts such as the spool as this can injure your finger.

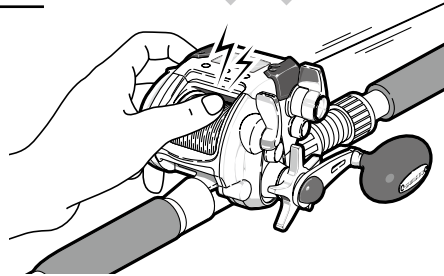

### Caution

- Please secure the reel securely to the rod. Do NOT use the reel if it is cross-threaded or not properly secured as it may come off during fishing and cause injury.

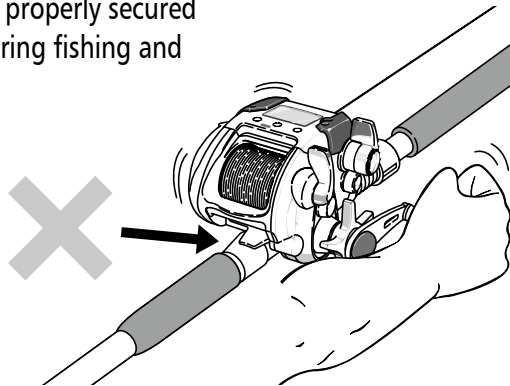

## Caution



### Caution

- Please store and use the reel out of the reach of children.

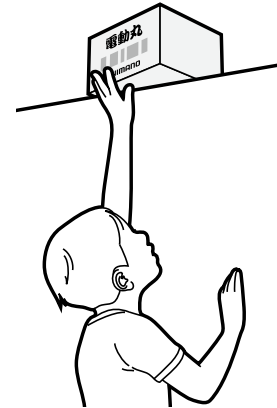

### Caution

- The reel may malfunction if it is dropped and the display damaged due to the impact. Please take care to avoid any such impacts.

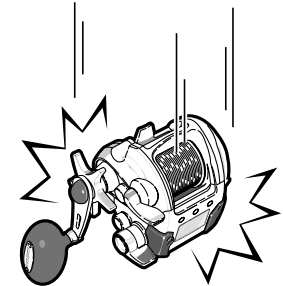

### Caution

- Do NOT wrap the cable around your body as depending on how the fish is pulled in it may cause you to be thrown into the sea.

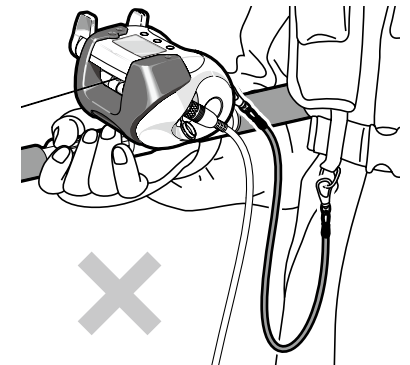



## Caution



### Caution

- ALWAYS remove the cable from the battery when carrying out maintenance on the reel when it is in use as the spool may move at any time causing injury to the user or damage to the reel.

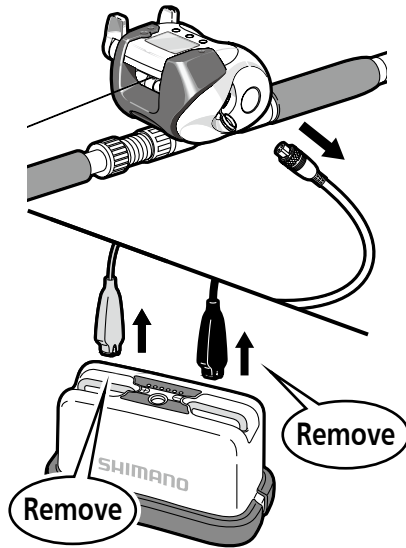

### Caution

- Always decrease drag before connecting the power supply. There is the possibility that the rod may be damaged if the motor malfunctions, cannot be stopped and retrieves the rig.

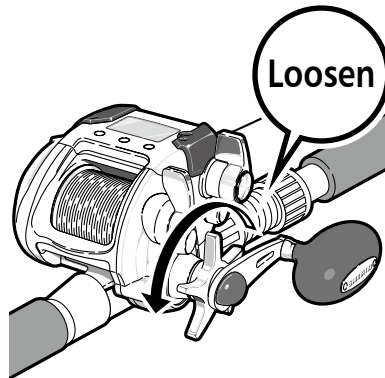

## Caution



### Do NOT Disassemble

- Please do not modify the reel as this can cause performance to deteriorate and safety features to malfunction.
- Please do not modify the cable as this may cause performance to deteriorate, generate heat or result in a fire.

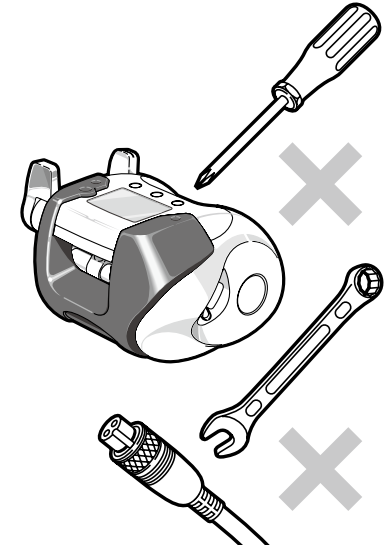

### Caution

- The gunwale stop position may change according to factors such as retrieval tension. If the gunwale stop position changes, please reset the counter to zero again. This is just in case the gunwale stop position changes, which can break the tip of the rod.

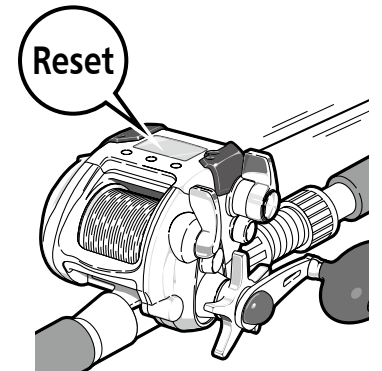



## Caution



### Caution

- Please do NOT touch the metal parts of the alligator clips or the terminals of the battery or power supply with wet hands as there is the danger of electric shock.

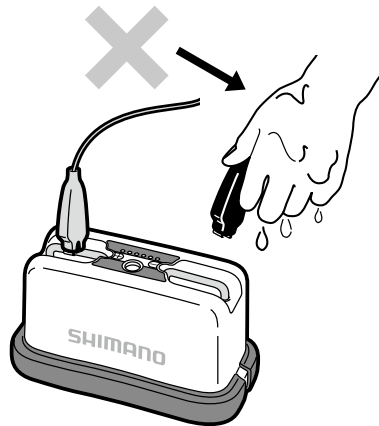

### Caution

- Check that the terminals are not wet before attaching the power cord to the reel. If the terminals are wet this can cause a short circuit, which may result in fire or smoke that can lead to injury.

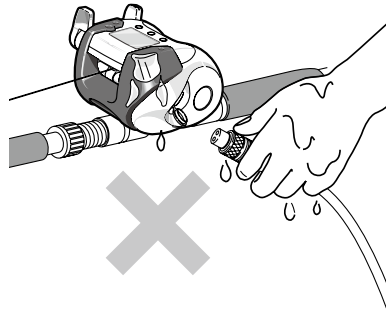

### Caution

- When the line is caught, do NOT exert excessive force on the rod or reel. Instead, please cut the line after taking care to minimize the amount of line left in the fishing ground.



## Caution



### Caution

- Do NOT try to dry the reel using a hair dryer or some other heating appliance after carrying out maintenance as this may deform the resin.

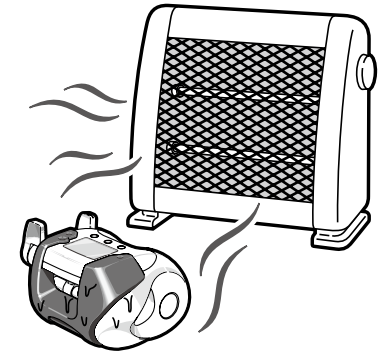

### Caution: Motor Malfunction

- The display is water-resistant to a depth of 10m. However, if the reel is dropped or receives an impact of some kind and the display is damaged or cracked, the motor may malfunction if water is able to penetrate into the reel. As injury may occur if the motor malfunctions and suddenly retrieves the line, etc., if the display is cracked or damaged, immediately remove the power cord, stop using the reel and return it to the place of purchase. If there is no licensed Shimano dealer nearby, please enquire as to the location of your nearest service center.
- This reel operates on DC12~24V. Using a higher voltage or a household power supply may damage the electronic circuits in the display and make it impossible to control the motor. As this could also result in smoke or fire, always check the specification of the power supply before use.

# Features



Handy for Kite Fishing

## Manual mode Page 49

When the counter shows 0.0 or less, the motor can be used for winding the line in.

※ When Manual Mode is OFF and the counter shows 0.0 or less, the motor cannot be used for winding the line in. The default setting is OFF.



Excitement-enhancing sound as the line pays out

## Electronic Drag Sound Page 14

The drag sound is generated electronically.

This energizing sound is produced to spur on the angler.



To pick up line slack or for controlling motion patterns

## Pick up Pages 11,13

The motor winds in the line for as long as the button is pressed.



Estimated measurement of bait spreading and rig retrieval timing

## Top-Down timer Page 11

Displays the elapsed time after the rig reaches the target depth from the surface.



Stabilizes the lowering speed to improve catching  
**Showing the estimated lowering speed**

 Page 11



Estimating the size and number of fish caught

## Electric winding load display

 Page 12, 14



Prevents rig from winding up into tip and alerts you to a strike

## Spool Free Mode Pages 59~60

Spool Free Mode enables two functions—the Overwinding Prevention Function and the Strike Detection Alarm.



Rust and Corrosion-Resistant Bearings

## Shielded Antirust Bearings Page 40

A special corrosion-resistant material is applied to the surface of conventional antirust bearings to minimize saltwater penetration and these bearings are located at strategic locations to achieve even smoother performance. Not only are these bearings resistant to rust, but they also minimize the formation of salt crystals inside the bearings, which can lead to corrosion.



Select between two modes when reeling in your fish.

## You can select between Rakuraku Mode and Fixed Speed Mode Pages

47~48

Select between Rakuraku Mode, which maintains a specific line tension, and Fixed Speed Mode, which maintains a fixed spool rotation speed, according to your situation.



Top-level performance within in its class

## Light/Compact

Achieves both a light weight and compact size



**Stops retrieving the line at the point where you can raise the rod vertical and have the rig come straight to your hand.**  Pages 41

The gunwale stop position is set automatically, allowing you to raise the rod vertical and have the rig come straight to your hand.



**Displays the time remaining for the rig to be retrieved.**  Page 58

Displays the time remaining for the rig to be retrieved to the gunwale using the motor.



**Allows you to easily return your rig to the same depth after repairing your line if it breaks.**  Page 39

If you break your line, after repairing it, lower the rig to the surface and press 0 Set. The Smart Line Depth function then automatically returns your rig to the same depth it was at before it broke.



## The Technical Lever

is used to adjust retrieval speed and Rakuraku settings.  Pages 15, 47~48



The new SLSIII system requires no programming.  
**SLSIII (Shimano Line Program System 3)**

 Pages 18~32



Correct any discrepancy between the display and the length of line used.

## Line Learning Adjustment

 Pages 61~63



Saved water depth displayed in the Saved Depth column

## Saved depth Pages 43

This stores the current depth from the surface or the bottom and displays it. In Bottom-Up mode, the depth is displayed in the Saved Depth column with the saved position represented by 0.



Select the method of displaying the saved depth.

## Switching between "Top-Down mode" and "Bottom-Up mode" Pages 44~46

If you would like to check the depth from the bottom in accordance with the fishing location, fishing method and the type of fish being caught, you can change the saved depth display method.

In Top-Down mode, the saved depth is displayed, but if you select Bottom-Up mode, you can check the depth with the saved depth position represented by 0.



## Let down your line faster with the Auto Casting function.

 Pages 13, 36



Replicates pro-angler reeling patterns or your own programmed technique

## Program Mode

### Replay program pattern Pages 50~57

The electric reel can reproduce various movement patterns. Three movement patterns are available—3 Step, 2 Step, and Repeat—plus a Learning Mode to program/select your own movement patterns.

The following icons appear in the manual and have the following meanings:

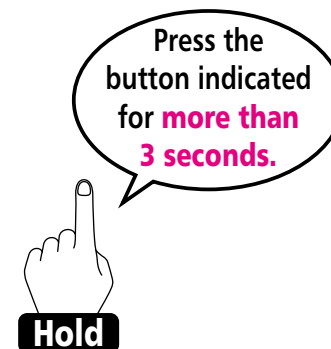
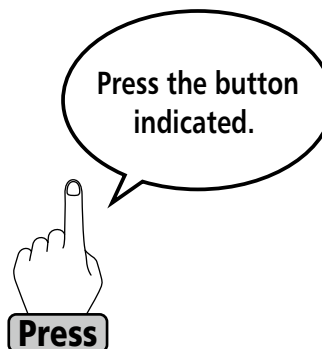

### Caution:

The values and settings shown on the reel display in this manual are in some cases just examples. Actual values may differ.

# Digital Display Component Names

## Technical Lever Settings

Displays Rakuraku mode and Fixed Speed Mode values.

## Top-Down timer

Displays the elapsed time after the rig reaches the target depth from the surface.

\* Times from 0 to 59 seconds are displayed in units of 1 second, and from 1 to 99 minutes in units of 1 minute.

When the time reaches 100 minutes, the display returns to 0 seconds.

## Lowering speed display

Displays the estimated lowering speed.

\* "( )" will flash in the display.

## Spool Free Mode

When in Spool Free Mode, the brackets disappear.

## Saved Depth

In Top-Down mode, the saved depth is displayed, and in Bottom-Up mode, the saved depth is displayed as zero.

## Present Depth

Displays depth from the surface of the water.

\* Depth is shown in 10cm graduations.

Depths over 100m are shown in 1m graduations as shown below.

999 → 100

## Indication of Current Function

Program pattern in operation:

[PGM] is displayed.

Switch to Rakuraku Mode:

The alarm beeps and (R) is displayed for 3 seconds.

Switch to Fixed Speed Mode:

The alarm beeps and (S) is displayed for 3 seconds.

## Low Charge Warning

If the charge is insufficient,  will flash.

(Charge status can be checked any time from the Menu Screen.)

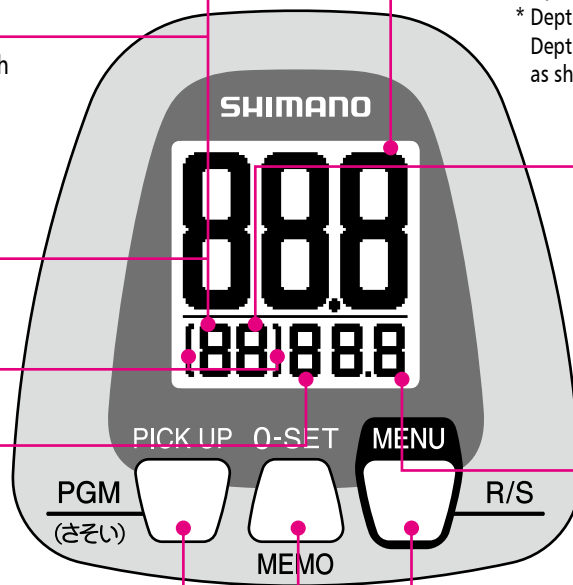

## PICK UP/PGM (Program) Button



Press

When Pick Up Mode is ON, the line will be wound in by motor for as long as the button is pressed.

Winding speed can be adjusted from 0 to Hi. (Default setting is 15.)

\* When Pick Up Mode is ON, Program Mode is automatically turned OFF.

\* After gunwale stop, Pick Up is deactivated.



Press

When Program Mode is ON, the movement pattern will start.

Use this button also to pause and restart.

\* When Program Mode is ON, Pick Up Mode is automatically turned OFF.

\* After gunwale stop, Program Mode is deactivated.

## 0 Set/Enter Button



Hold

Zeroing the Counter

Lower the rig to the surface of the water and zero the counter.

\* It may not be possible to zero the counter if Jigging Mode is ON. Always turn Jigging Mode OFF before zeroing the counter.



Press

Press Enter to turn ON or OFF the function selected using the Menu button.

## When Electric Winding Load Display and Rig Retrieval Time are ON

As shown below, the status is shown under the **Current Depth** display.

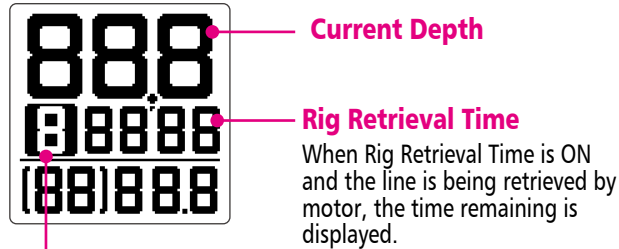

### Electric Winding Load Display

When Electric Winding Load Display is ON and the line is being retrieved by motor, the estimated line tension is displayed. Depending on the load, the number will vary between 0 and 9. Caution: When the Electric Winding Load Display and Rig Retrieval Time Display are ON, and the Bottom Depth Display and Target Depth Display are ON, Bottom Depth Display and Target Depth Display take priority in the middle row. However, if the motor is in operation, the display automatically switches to Electric Winding Load Display and Rig Retrieval Time Display.

## Menu R / S (Rakuraku/Fixed Speed) Button



Press

Press to switch between Rakuraku Mode and Fixed Speed Mode. You can press this button even when reeling in.

The mode selected will be shown on the display.

**R** (Rakuraku Mode): Green Backlight

**S** (Fixed Speed Mode): Orange Backlight



Hold

The Menu Screen is displayed.

Various settings can be changed from the Menu.

See the diagram to the right for how to operate the Menu Screen.

## Basic Menu Screen Operation

Press and hold the MENU button for 3 seconds and you will hear two short beeps and the Menu Screen below will appear.

### Menu Screen

Scroll through the list by moving the cursor up or down. For the list of functions with settings that can be changed from the Menu, see the next page of this manual.

### Cursor

Highlights the menu item. Use the cursor to select the function.

Displays the functions of the buttons. Please use this as a guide for operation.

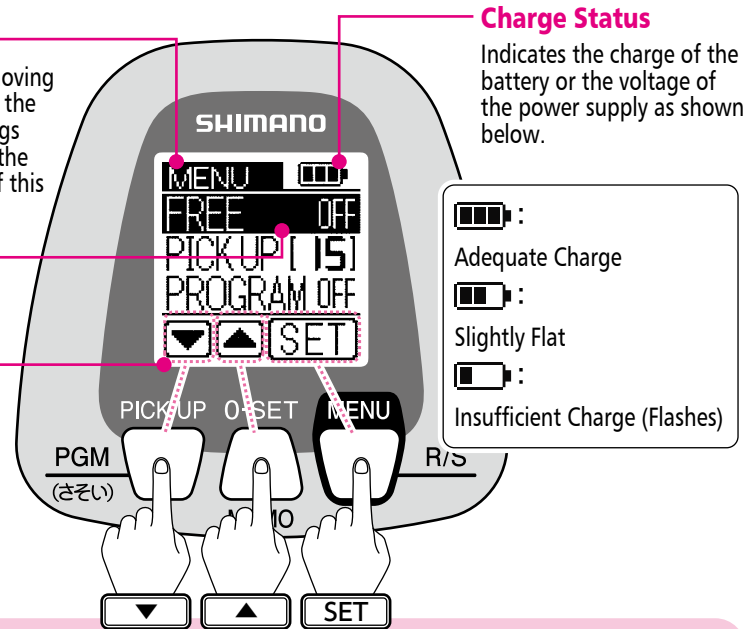

These buttons move the cursor up or down. When setting values, they are used to increase or decrease the value by 1..

Sets the function (or entered value) selected by the cursor.

To return to the Water Depth Display, select RETURN from the Menu Screen and press SET.

If the motor or handle is used to wind up the line, the screen changes to the Water Depth Display from the Menu Screen.

For the list of functions with settings (さそい) that can be changed from the Menu, see the next page of this manual. →



# Functions with Settings that Can Be Changed from the Menu

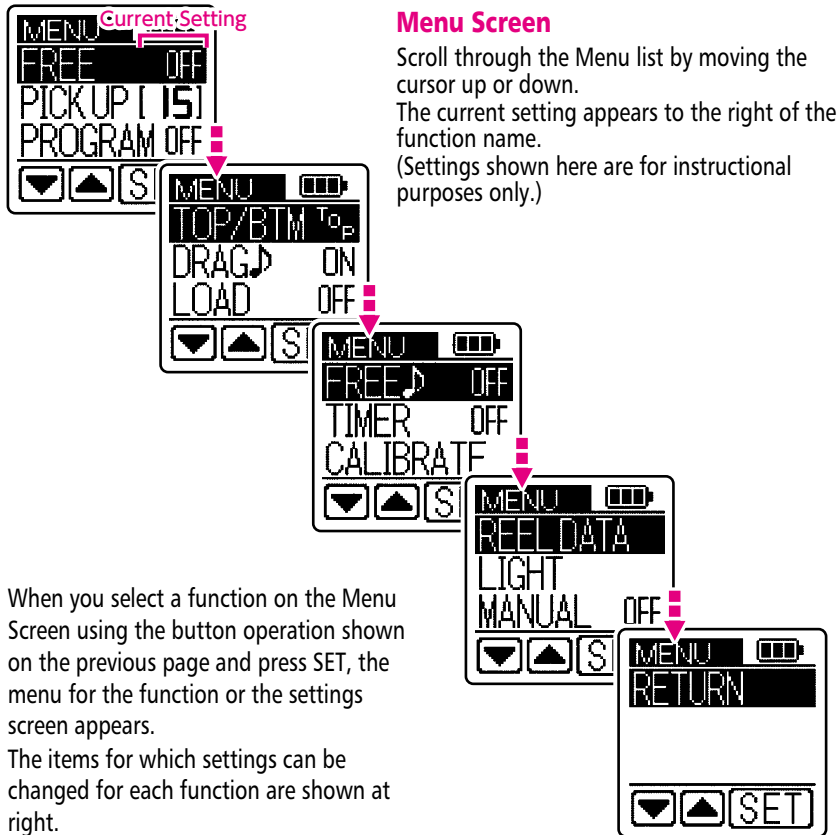

**Menu Screen**

Scroll through the Menu list by moving the cursor up or down. The current setting appears to the right of the function name. (Settings shown here are for instructional purposes only.)

When you select a function on the Menu Screen using the button operation shown on the previous page and press SET, the menu for the function or the settings screen appears.

The items for which settings can be changed for each function are shown at right.

After each function is set, the screen will return to the Menu Screen. To return to the Water Depth Display, select RETURN from the Menu Screen and press SET.

\*When you change a setting from the default, the setting is saved even after the power is turned off.

## Casting (Auto Casting Function)

This function can be turned ON or OFF.

With auto casting, when lowering the rig, at 5m past the gunwale stop position, the motor starts automatically, minimizing spool resistance. (Example: If the gunwale stop position is 1m, the motor starts at 6m.)



## PICK UP

This function can be turned ON or OFF.

When ON, the winding speed can be set from 0 to Hi.



### Setting the Pick Up Speed

When set to ON, you can make adjustments from the Pick Up speed setting screen (above right).

Use ▼▲ to increase or decrease the value to the speed you want, and press SET.

※ When Pick Up Mode is ON, Program Mode is automatically turned OFF.

## PGM (Program Mode)

Turn this function ON or OFF. When set to ON, you can select an available movement pattern or program/select your own pattern.

※ When Program Mode is ON, Pick Up Mode is automatically turned OFF.

See pages 50–57 for details.

(Continued on the next page.)

## TOP/BTM (Top-Down/Bottom-Up)

Switch between Top-Down and Bottom-Up Modes.

See pages 44–46 for details.

## DRAG (Electronic Drag Sound)

Turn this function ON or OFF.

This sound is generated electronically when the line pays out under pressure. It is an energizing drag sound produced to spur on the angler.



## LOAD (Electric Winding Load Display)

Turn the display ON or OFF.

See page 12 for details.



## TIMER (Rig Retrieval Time)

Turn this function ON or OFF.

See page 58 for details.

## FREE (Spool Free Mode)

Turn this function ON or OFF.

When set to ON, the Strike Detection Alarm speed can be set from 0 to Hi.

When Spool Free Mode is ON, two functions are enabled—the Overwinding Prevention Function and the Strike Detection Alarm.

※ After "Fluoro Learning Mode E2" for Line Learning is completed, Spool Free Mode turns ON automatically.

See pages 59–60 for details.

## CALIBRATE (Line Learning Adjustment)

Adjust to eliminate the discrepancy between actual line markers and the water depth counter.

See pages 61–63 for details.

## REEL DATA

Check the reel data (line retrieval distance/time taken).

## LIGHT (Backlight)

Choose from four colors—the default setting, red, green or blue. You can also change the brightness to one of ten levels.

## MANUAL (Manual mode)

Turn manual mode ON or OFF.

## RETURN (to Water Depth Display)

Exit the Menu Screen and return to the Water Depth Display.

# Part Names

## Digital Counter

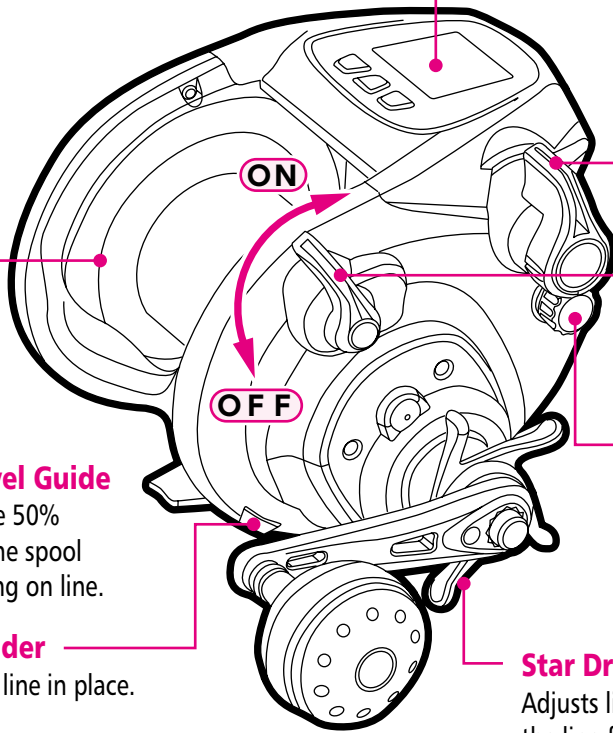

## Line Level Guide

Shows the 50% level on the spool for winding on line.

## Line Holder

Holds the line in place.

## Star Drag

Adjusts line delivery tension to prevent the line from breaking when a fish is pulling hard.

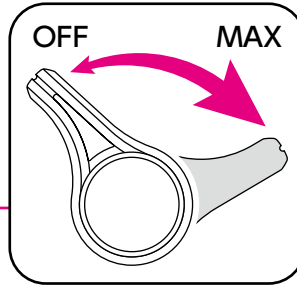

## Technical Lever

Allows you to instantly adjust retrieval speed and Rakuraku Mode tension settings. After gunwale stop, if you want to restart the motor, then turn the lever to the OFF position once before restarting. In the interests of safety, however, this does not work if the counter displays 1.0m or less even if the lever is moved to the ON position.



## Clutch Lever

ON when the handle is turned clockwise or turned by hand.

**ON** : Retrieves the rig.

**OFF** : Frees the spool and allows the rig to drop.

## Mechanical Brake Knob

Brakes spool rotation and prevents backlash when lowering the rig.

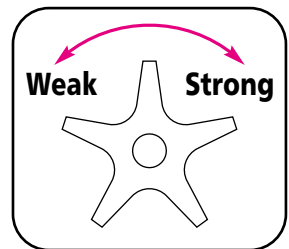

## DDL (Direct Drive Level Winder)

\* Be careful not to get your finger caught.

## Safety Level Wind Cover

(Also protects the counter unit.)

## Power Cord Socket

\* Always replace the connector cap when not using the reel.

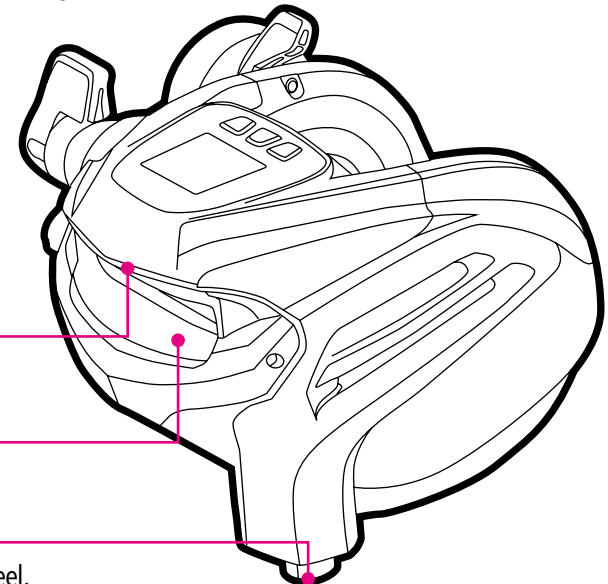

## 1 Handling Precautions

### Power Supply

This reel can use 12~24V DC power supply with a nominal voltage of 12~24V (lithium-ion batteries, etc.). Do NOT use the reel with any kind of unspecified power supply (e.g. a vessel's on-board power supply or a AC100 household power supply). NEVER use a battery charger.

- When using a vessel's on-board power supply, always check that the voltage is DC12V~24V. If the battery terminals are corroded, the voltage may not be stable, which can cause the reel to malfunction.
- Only use a fully charged battery.
- If a battery is used for a long period of time it loses charging capacity. If that occurs get a new battery.
- NEVER use an AC power supply as it will destroy the reel's electronics.
- It may not be possible to properly attach the alligator clips to the terminals of other batteries from other manufacturers and in some cases using batteries from other manufacturers may cause damage to such batteries.
- If you use a vessel's on-board power supply there is the possibility that other powered reels may stop working.
- The recommended battery is an automobile battery with a capacity of 10Ah.

### Power Cord

Always use a genuine Shimano power cord to connect your reel to the power supply. The power cord is a consumable. Depending on frequency of use, it may need to be changed every 2~3 years.

#### Caution

Using a power cord other than a genuine Shimano item may cause the reel to malfunction. Please do not treat the power cord in a rough manner, stand on it or fold or bend it as this can cause it to break.

This is an extremely high-powered reel.

Although power cords for powered reels from other manufacturers can be connected, please ensure that you use only a genuine Shimano power cord as electrical resistance inside the cable is especially low.

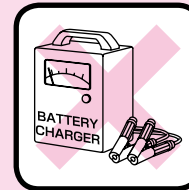
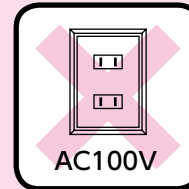
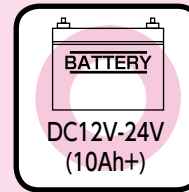

## 2 Connecting a Battery

**1** Please use the supplied power cord to connect to the battery. Firstly connect the red connector to the positive electrode and the black connector to the negative electrode.

**2** Next connect the power cord to the reel.

Line up the connections and insert the power cord into the socket in the bottom of the reel, pushing it firmly in and then tightening the lock screw.

\* Please do NOT push any buttons while connecting the power cord.

\* A slight amount of play may occur in some products, but this will not cause problems during operation.

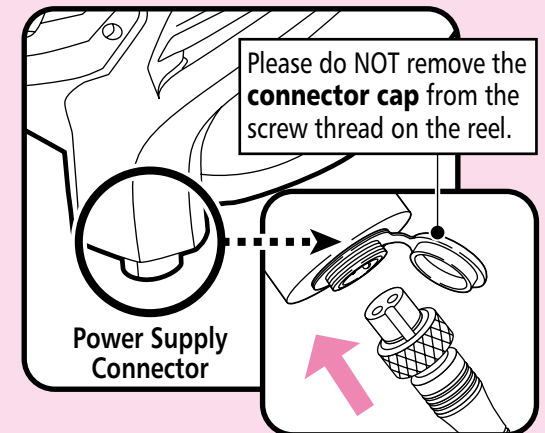

## Spooling Up the Line

- 1 Feed the line through the level winder.  
When threading the line, use the threading pin provided.

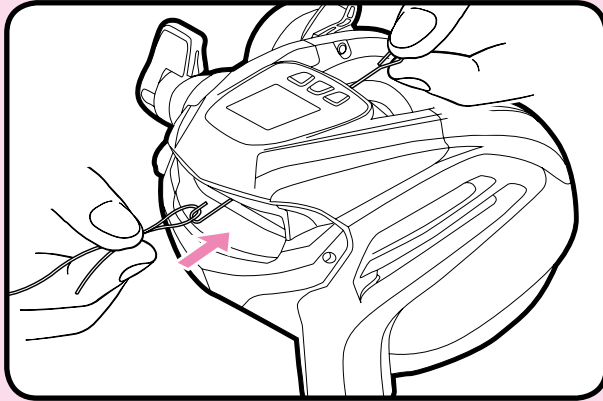

- 2 Tie the line to the spool pin.

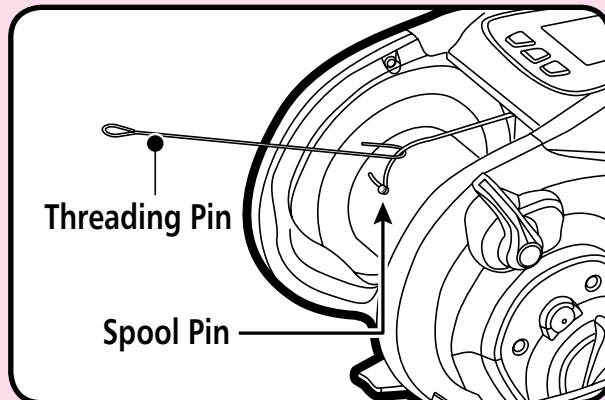

## Selecting Learning Methods

Firstly, change from standard mode to learning mode as shown below. Be sure to select the learning method that best matches the type of line you will be using.

Please refer to the following page for details regarding each learning method.

- \* This operation cannot be carried out unless a power supply is connected.
- \* Carry out this operation when the display shows less than 6m. Please reset the counter if the value displayed is greater than 6.1m.

### Caution

In some cases the display may go blank if learning is carried out at  insufficient voltage. If this happens, replace the battery and carry out learning again from the beginning.

# Learning Mode

## Standard Mode

Used when actually fishing. The reel is in this mode when the power is initially turned ON.

(\* Initial screen)

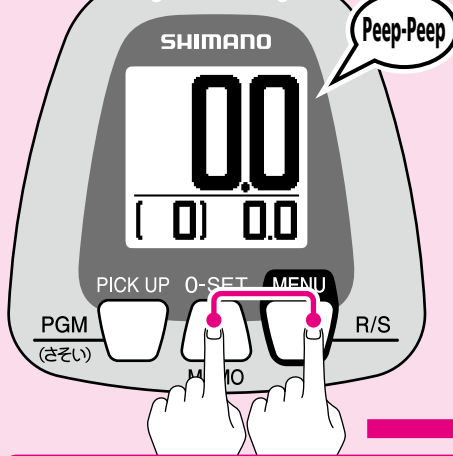

Press and hold both the O-SET and MENU buttons for 3 seconds to enter Line Learning Mode.

## Learning Method

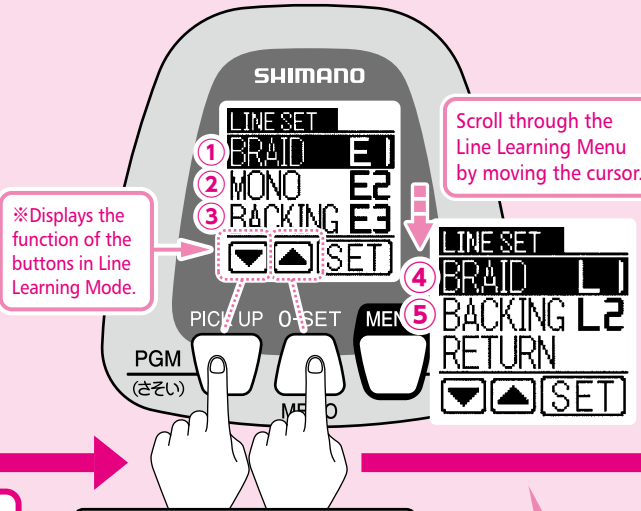

※Displays the function of the buttons in Line Learning Mode.

Scroll through the Line Learning Menu by moving the cursor.

※Choices shown are for instructional purposes only.

When set, the selected learning method will start. See the pages indicated below for details on the various learning methods!

Use ▼▲ to select learning method

Press to set

- ① **Learning Mode E1**  
NEW SLS III Braided line Learning ... P19~P20
- ② **Learning Mode E2**  
NEW SLS III Nylon/Fluoro Learning ... P21~P22
- ③ **Learning Mode E3**  
NEW SLS III Backing Line Learning ... P23~P26

- ④ **Learning Mode L1**  
Conventional SLS II PE Learning ... P27~P28
- ⑤ **Learning Mode L2**  
Conventional SLS II Backing Line Learning ... P29~P32



## 1 Simple, convenient NEW SLS III Winding Learning Braided Line Learning (E1)

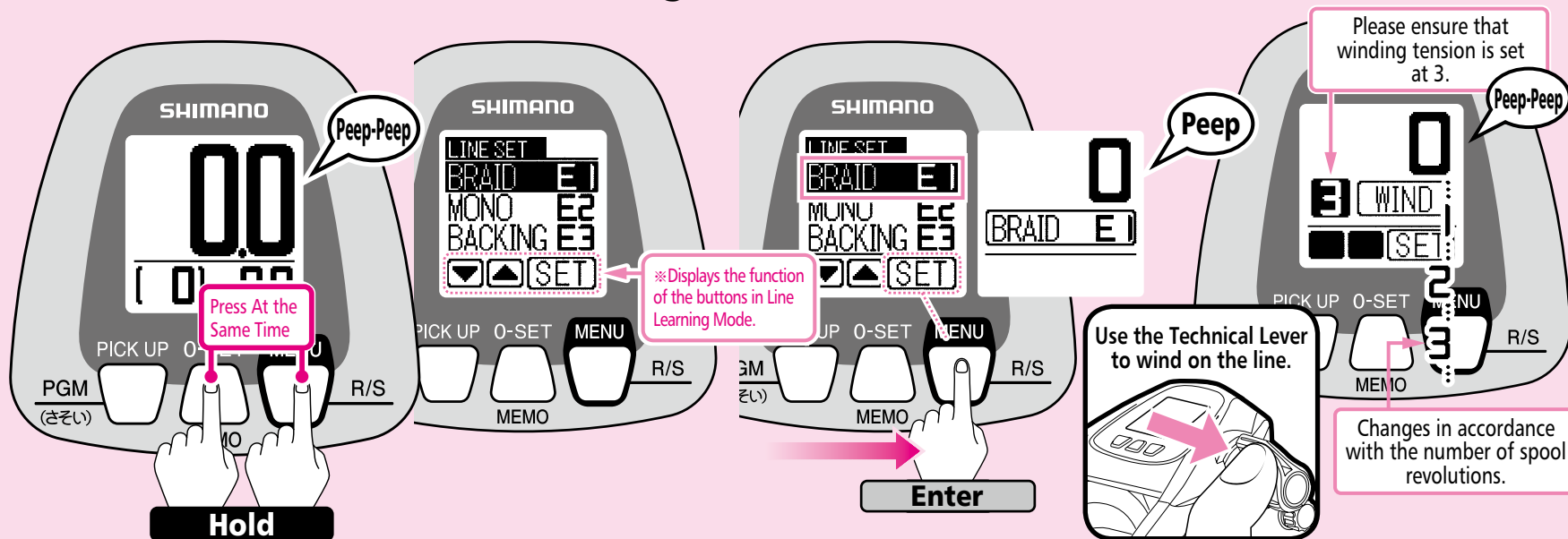

**1** Carry out this operation if the counter value is 6m or less.

If the value displayed is 6.1m or more, reset the counter. (Refer to pages 37.)

**Set the clutch lever to ON.**

**Then, check that the power supply is connected.**

The digital display will show the following.  
(When in Standard Mode)

**Press the 0 SET button and the MENU button at the same time for more than 3 seconds to enter Learning Mode.**

**2** The Line Learning Menu appears.

※ The button functions change when in Line Learning Mode, so refer to their functions shown on the bottom row of the display.

**Check that Braided Line Learning E1 is selected and press SET.**

The display changes to the one shown above.

(See pages 17–18 for details on selecting learning methods.)

**3** Use the Technical Lever to wind on the line.

A number corresponding to the number of spool revolutions will be displayed.

**Operate at a winding tension of 3.**

This value indicates the force (line tension) applied for winding the reel as a number. The number does not equal kilograms. In addition, it will differ from the value which appears in Rakuraku Mode.

**When winding using the Technical Lever, the speed can be adjusted using the Technical Lever. To stop winding, set the Technical Lever to the "OFF" position.**

**Caution:** The values and settings shown on the reel display in this manual are in some cases just examples. Actual values may differ.

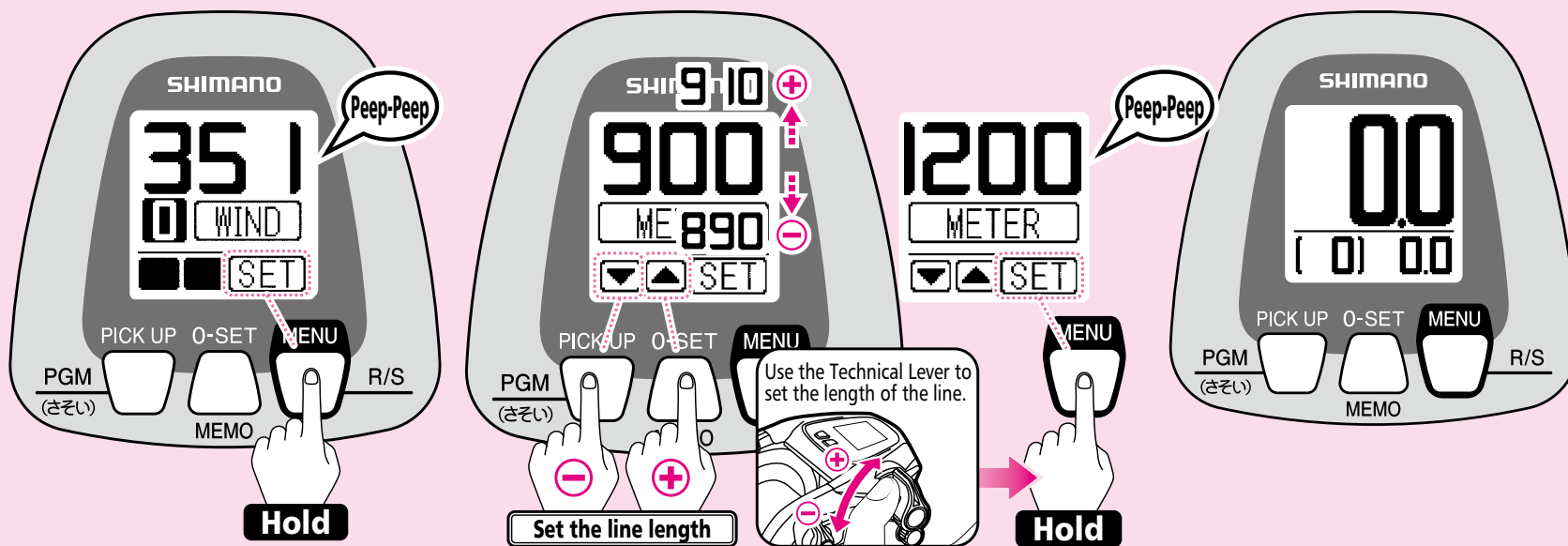

- 4** After completely finishing winding on the line, press the MENU button for more than 3 seconds.

The alarm will sound (peep-peep).

**Note:**

Do not wind on all of the line. If all of the line is wound on, it will cause an error in the counter value.

- 5** Set the line length using ▼▲ or the Technical Lever and press and hold the MENU button for 3 seconds.

You will hear two short beeps.

※ The default setting is 900m. (The illustration shows a change made from 900m to 1200m.)

- 6** The display will return to Standard Mode and learning will be complete.

(In some cases there may be as much as a  $\pm 3\%$  difference between the counter value and the actual length of the line.)

\* This difference is the difference in the first cast made after learning.

\* After this when actually fishing, if you think that the difference is too great, carry out Line Learning Adjustment as shown on pages 61. This will enable you to position your rig more accurately.



## 2 Simple, convenient NEW SLS III Winding Learning Nylon/Fluoro learning (E2)

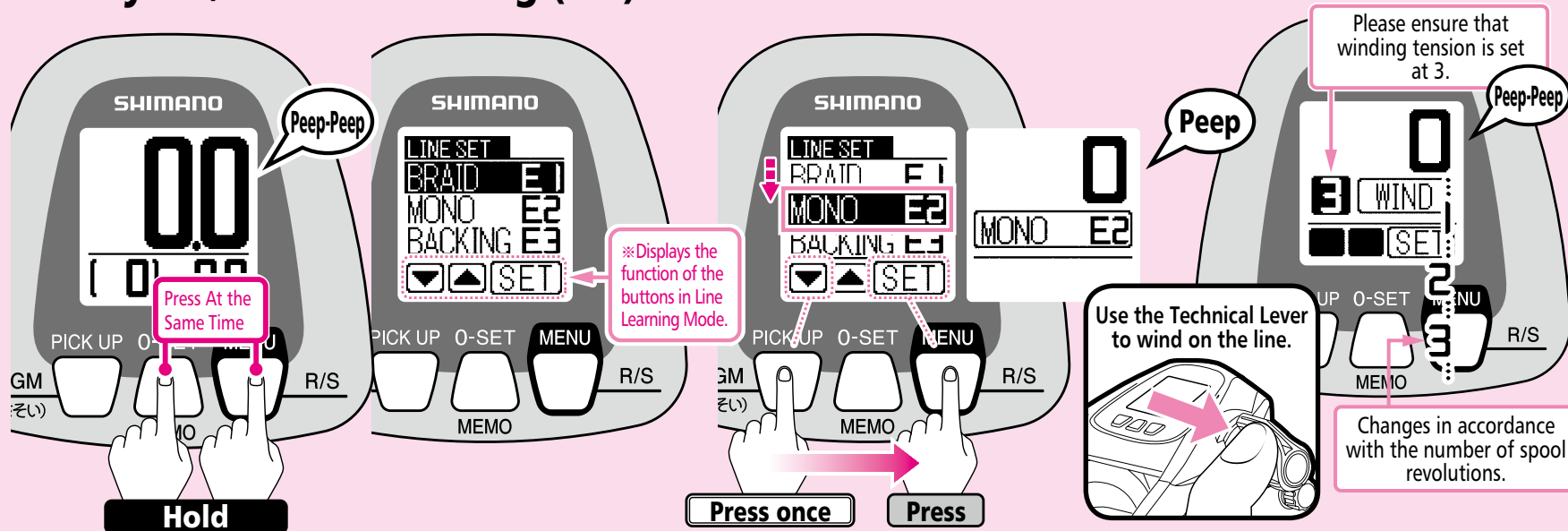

**1** Carry out this operation if the counter value is 6m or less.

If the value displayed is 6.1m or more, reset the counter. (Refer to pages 37.)

**Set the clutch lever to ON.**

**Then, check that the power supply is connected.**

The digital display will show the following.  
(When in Standard Mode)

**Press the 0 SET button and the MENU button at the same time for more than 3 seconds to enter Learning Mode.**

**2** The Line Learning Menu appears.

※ The button functions change when in Line Learning Mode, so refer to their functions shown on the bottom row of the display.

**Check that Fluoro Learning E2 is selected and press SET.**

The display changes to the one shown above.

(See pages 17–18 for details on selecting learning methods.)

**3** Use the Technical Lever to wind on the line.

A number corresponding to the number of spool revolutions will be displayed.

**Operate at a winding tension of 3.**

This value indicates the force (line tension) applied for winding the reel as a number. The number does not equal kilograms. In addition, it will differ from the value which appears in Rakuraku Mode.

**When winding using the Technical Lever, the speed can be adjusted using the Technical Lever. To stop winding, set the Technical Lever to the "OFF" position.**

**Caution:** The values and settings shown on the reel display in this manual are in some cases just examples. Actual values may differ.

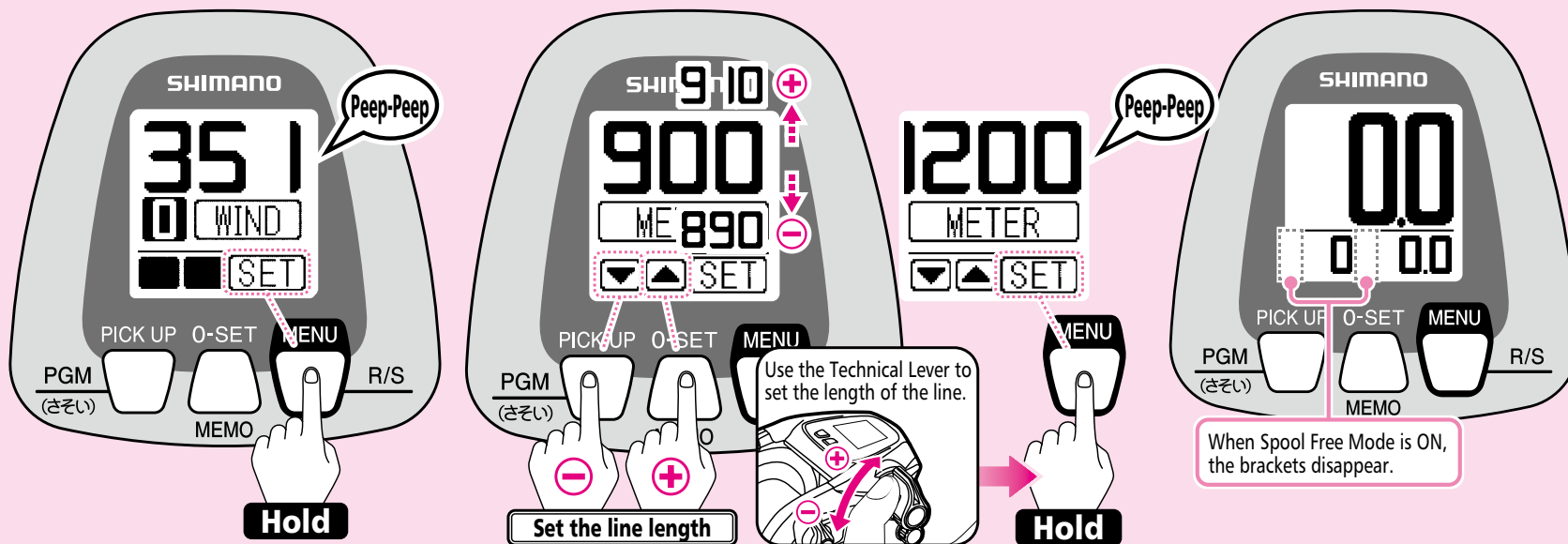

- 4** After completely finishing winding on the line, press the MENU button for more than 3 seconds.

The alarm will sound (peep-peep).

**Note:**

Do not wind on all of the line. If all of the line is wound on, it will cause an error in the counter value.

- 5** Set the line length using ▼▲ or the Technical Lever and press and hold the MENU button for 3 seconds.

You will hear two short beeps.

※ The default setting is 900m. (The illustration shows a change made from 900m to 1200m.)

When the "NEW SLS III Nylon/Fluoro" Learning Mode (E2) is selected, the "( )" will not be displayed.

\* This indicates that the Gunwale Stop function is operating.

- 6** The display will return to Standard Mode and learning will be complete.

(In some cases there may be as much as a  $\pm 3\%$  difference between the counter value and the actual length of the line.)

\* This difference is the difference in the first cast made after learning.

\* After this when actually fishing, if you think that the difference is too great, carry out Line Learning Adjustment as shown on pages 61. This will enable you to position your rig more accurately.

## 3 Simple, convenient NEW SLS III Winding Learning Backing Line Learning (E3)

There is a mark on the spool showing 50% capacity for backing line. Use this as an estimate when winding on backing line.

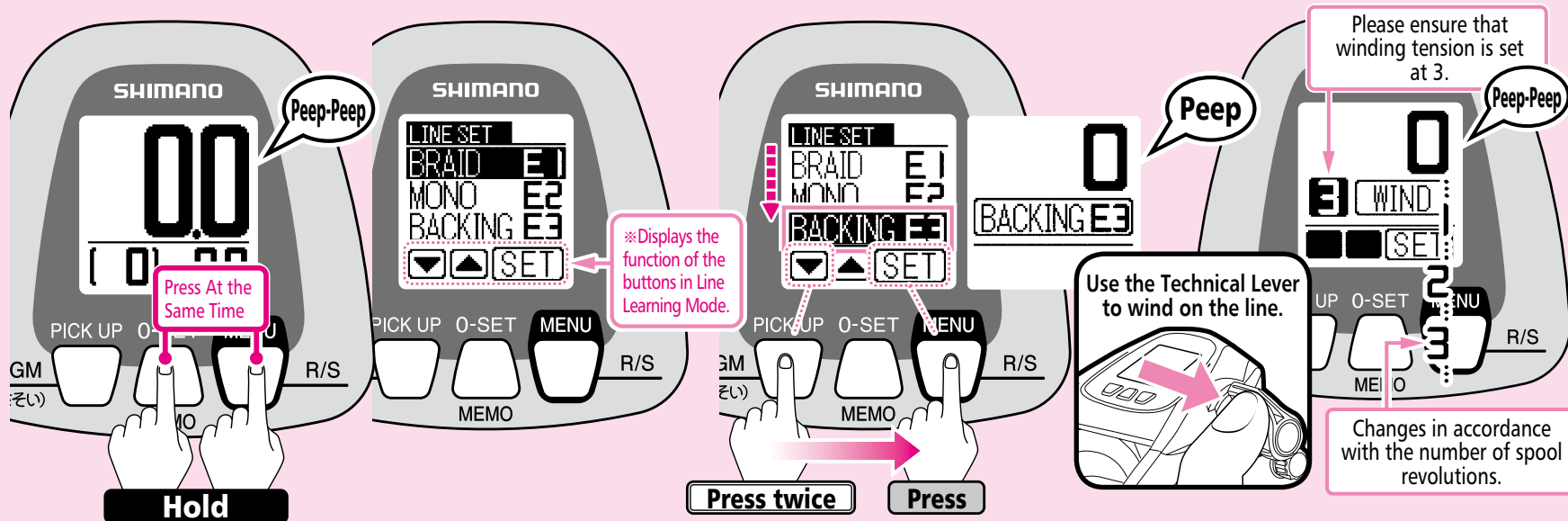

**1** Carry out this operation if the counter value is 6m or less.

If the value displayed is 6.1m or more, reset the counter. (Refer to pages 37.)

**Set the clutch lever to ON.**

**Then, check that the power supply is connected.**

The digital display will show the following. (When in Standard Mode)

**Press the O SET button and the MENU button at the same time for more than 3 seconds to enter Learning Mode.**

**2** The Line Learning Menu appears.

※ The button functions change when in Line Learning Mode, so refer to their functions shown on the bottom row of the display.

**Check that Backing Line Learning E3 is selected and press SET.**

The display changes to the one shown above.

(See pages 17–18 for details on selecting learning methods.)

**3** Use the Technical Lever to wind on the line.

A number corresponding to the number of spool revolutions will be displayed.

**Operate at a winding tension of 3.**

This value indicates the force (line tension) applied for winding the reel as a number. The number does not equal kilograms. In addition, it will differ from the value which appears in Rakuraku Mode.

**When winding using the Technical Lever, the speed can be adjusted using the Technical Lever. To stop winding, set the Technical Lever to the "OFF" position.**

**Caution:** The values and settings shown on the reel display in this manual are in some cases just examples. Actual values may differ.

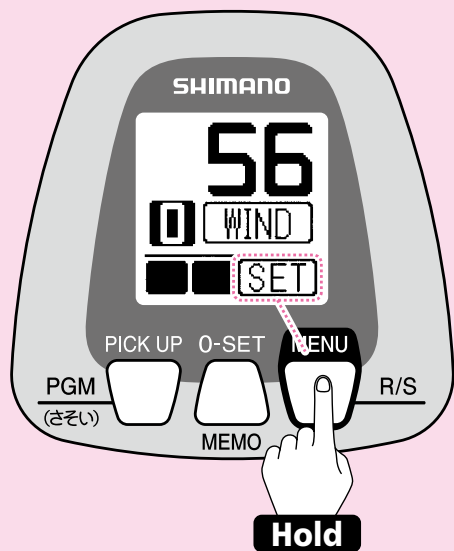

**4** After completely finishing winding on the backing line, press the 0 SET button for more than 3 seconds.

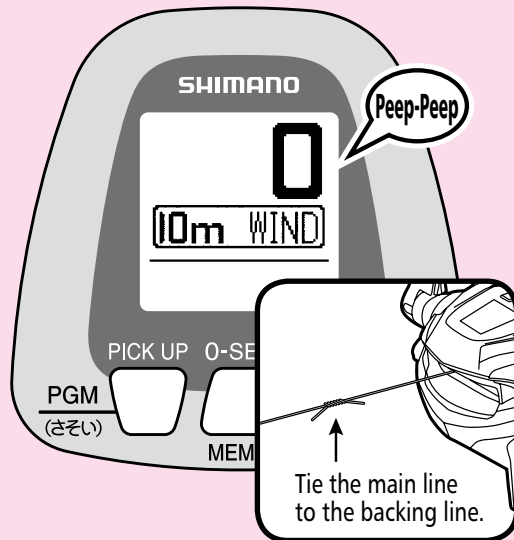

**5** The alarm will sound (peep-peep) and the display will appear as shown in the diagram. Once winding-on is finished, tie the main line to the backing line.

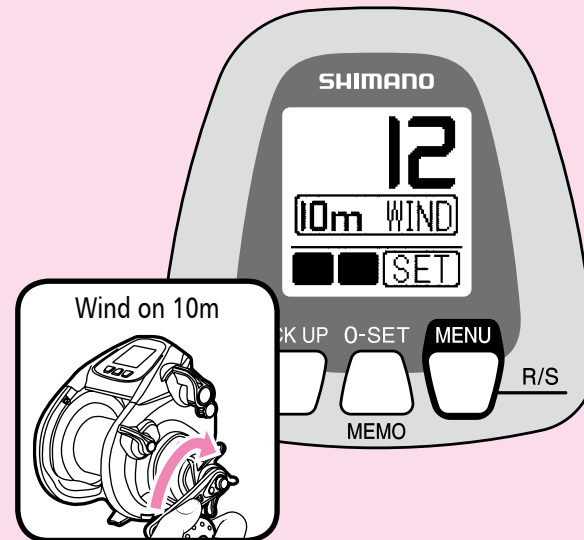

**6** Accurately wind on 10m of main line. The display changes in accordance with the number of spool revolutions.

**Caution:** The values and settings shown on the reel display in this manual are in some cases just examples. Actual values may differ.

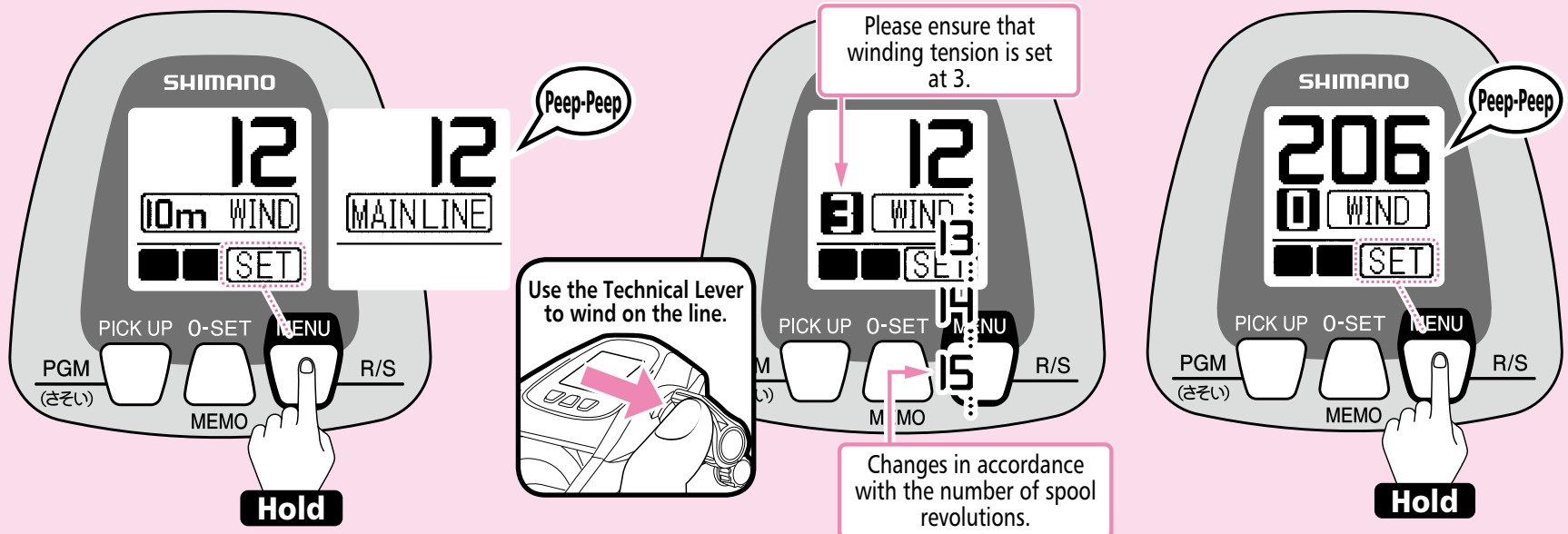

- 7** Press the MENU button for more than 3 seconds.  
The alarm will sound (peep-peep) and the display will appear as shown in the diagram.

- 8** Use the Technical Lever to wind on the line.  
A number corresponding to the number of spool revolutions will be displayed.  
**Operate at a winding tension of 3.**  
This value indicates the force (line tension) applied for winding the reel as a number. The number does not equal kilograms. In addition, it will differ from the value which appears in Rakuraku Mode.  
**When winding using the Technical Lever, the speed can be adjusted using the Technical Lever. To stop winding, set the Technical Lever to the "OFF" position.**

- 9** After completely finishing winding on the line, press the 0 SET button for more than 3 seconds.  
The alarm will sound (peep-peep).

**Note:**  
Do not wind on all of the line. If all of the line is wound on, it will cause an error in the counter value.

**Caution:** The values and settings shown on the reel display in this manual are in some cases just examples. Actual values may differ.

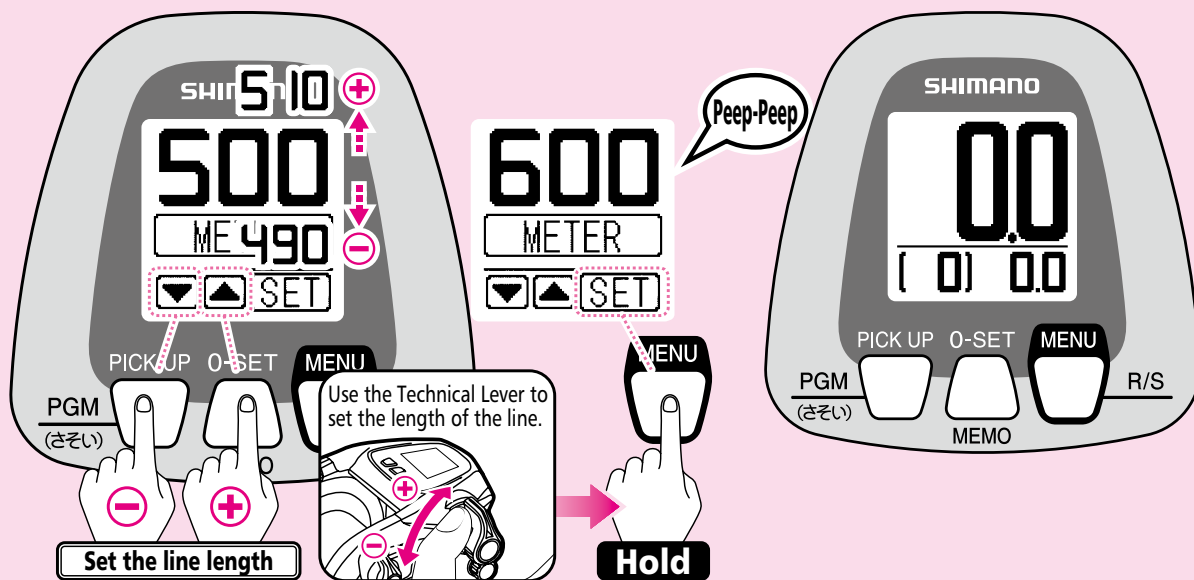

- 10** Use the lever to set the length of the main line, and then press the MENU button for more than 3 seconds.

The alarm will sound (peep-peep).

\* The initial setting is 500m. (The diagram shows the setting changed from 500m to 600m.)

\* If you accidentally press the MENU button while carrying out an input operation, the data entered up until that point will be lost and you will have to repeat the process once more from the beginning.

- 11** The display will return to Standard Mode and learning will be complete.

(In some cases there may be as much as a  $\pm 3\%$  difference between the counter value and the actual length of the line.)

\* This difference is the difference in the first cast made after learning.

\* After this when actually fishing, if you think that the difference is too great, carry out Line Learning Adjustment as shown on pages 61. This will enable you to position your rig more accurately.

## 4 Conventional SLS II Winding Learning Braided Line Learning (L1)

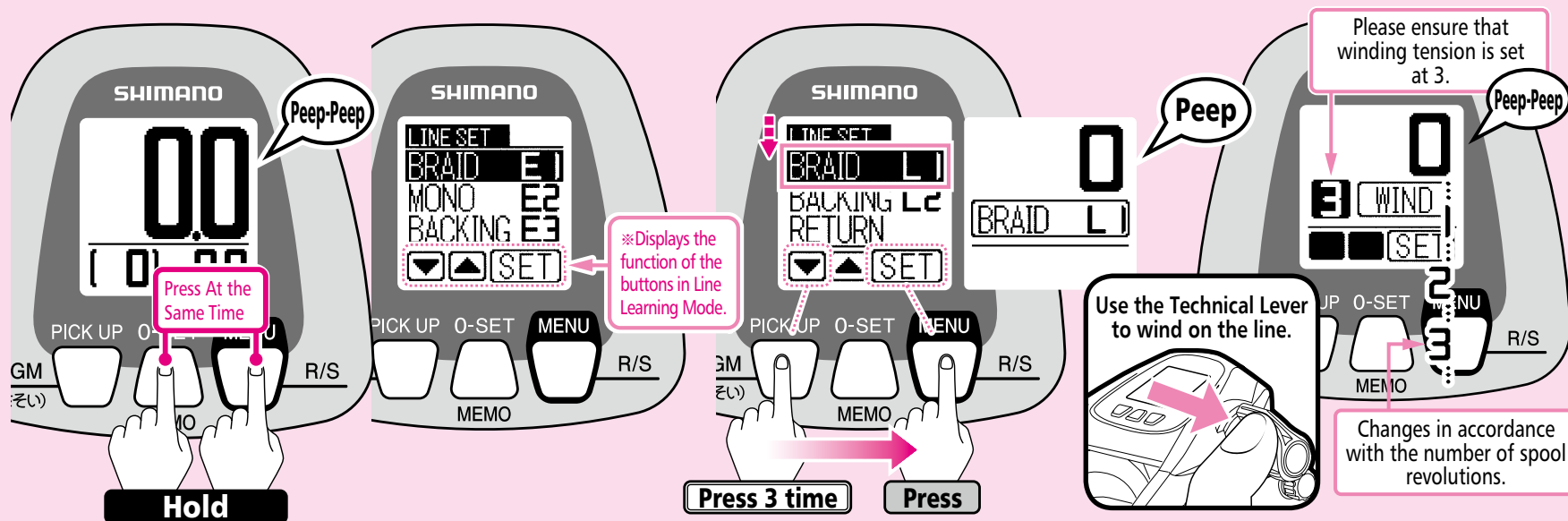

- 1** Carry out this operation if the counter value is 6m or less.

If the value displayed is 6.1m or more, reset the counter. (Refer to pages 37.)

Set the clutch lever to ON.

Then, check that the power supply is connected.

The digital display will show the following.  
(When in Standard Mode)

Press the 0 SET button and the MENU button at the same time for more than 3 seconds to enter Learning Mode.

- 2** The Line Learning Menu appears.

※ The button functions change when in Line Learning Mode, so refer to their functions shown on the bottom row of the display.

Check that Braided Line Learning L1 is selected and press SET.

The display changes to the one shown above.

(See pages 17–18 for details on selecting learning methods.)

- 3** Use the Technical Lever to wind on the line.

A number corresponding to the number of spool revolutions will be displayed.

Operate at a winding tension of 3.

This value indicates the force (line tension) applied for winding the reel as a number. The number does not equal kilograms. In addition, it will differ from the value which appears in Rakuraku Mode.

When winding using the Technical Lever, the speed can be adjusted using the Technical Lever. To stop winding, set the Technical Lever to the "OFF" position.

(Continued on the next page.)

**Caution:** The values and settings shown on the reel display in this manual are in some cases just examples. Actual values may differ.

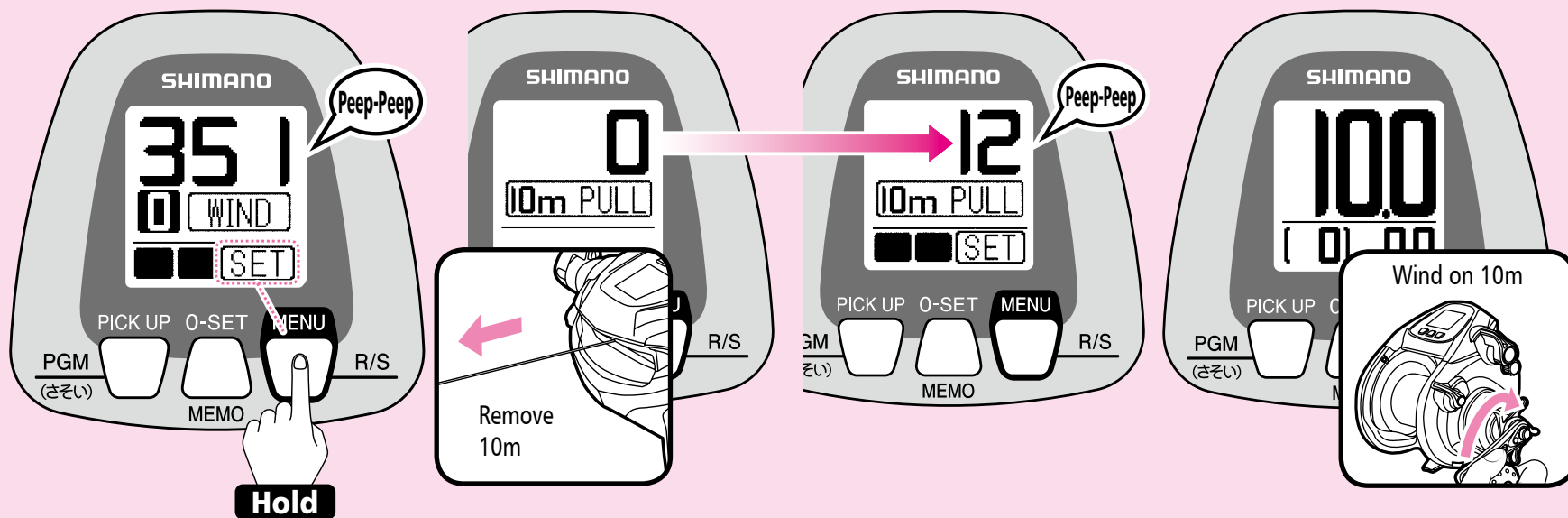

- 4** After completely finishing winding on the line, press the MENU button for more than 3 seconds.

The alarm will sound (peep-peep).

**Note:**

Do not wind on all of the line. If all of the line is wound on, it will cause an error in the counter value.

- 5** Accurately pull out 10m of line. (Check the changes in colour every 10m, or the number of marks occurring every 1m.) To finish learning, press the MENU button for more than 3 seconds.

The alarm will sound (peep-peep).

- 6** The display will return to Standard Mode and learning will be complete.

(In some cases there may be as much as a  $\pm 3\%$  difference between the counter value and the actual length of the line.)

\* This difference is the difference in the first cast made after learning.

\* After this when actually fishing, if you think that the difference is too great, carry out Line Learning Adjustment as shown on pages 61. This will enable you to position your rig more accurately.

- 7** Wind on the 10m of line that was pulled out.



## 5 Conventional SLS II Backing Line Learning (L2)

There is a mark on the spool showing 50% capacity for backing line. Use this as an estimate when winding on backing line.

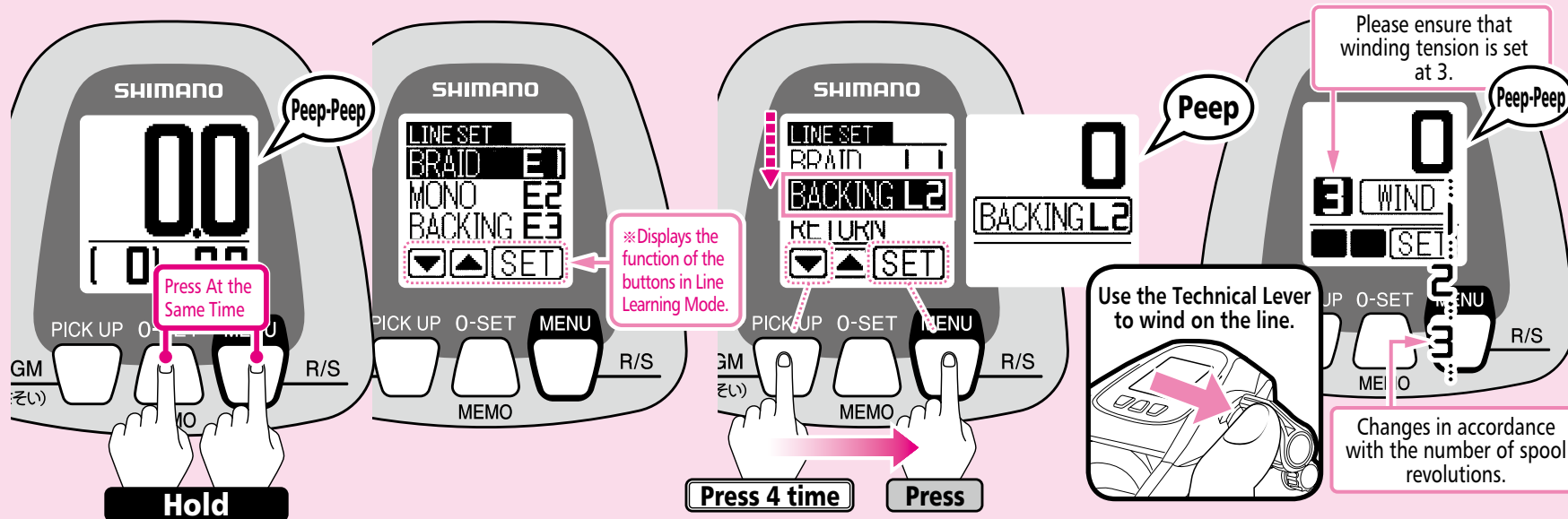

- 1 Carry out this operation if the counter value is 6m or less.  
If the value displayed is 6.1m or more, reset the counter. (Refer to pages 37.)  
**Set the clutch lever to ON.**  
**Then, check that the power supply is connected.**  
The digital display will show the following.  
(When in Standard Mode)

- 2 The Line Learning Menu appears.  
※ The button functions change when in Line Learning Mode, so refer to their functions shown on the bottom row of the display.  
**Check that Braided Line Learning L2 is selected and press SET.**  
The display changes to the one shown above.  
(See pages 17–18 for details on selecting learning methods.)

- 3 Use the Technical Lever to wind on the line.  
A number corresponding to the number of spool revolutions will be displayed.  
**Operate at a winding tension of 3.**  
This value indicates the force (line tension) applied for winding the reel as a number. The number does not equal kilograms. In addition, it will differ from the value which appears in Rakuraku Mode.  
**When winding using the Technical Lever, the speed can be adjusted using the Technical Lever. To stop winding, set the Technical Lever to the "OFF" position.**

(Continued on the next page.) →

**Caution:** The values and settings shown on the reel display in this manual are in some cases just examples. Actual values may differ.

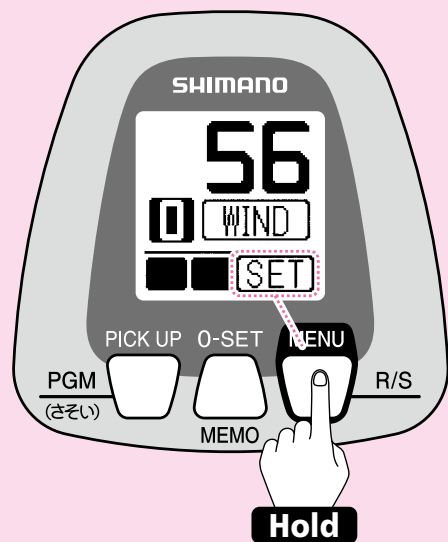

**4** After completely finishing winding on the backing line, press the MENU button for more than 3 seconds.

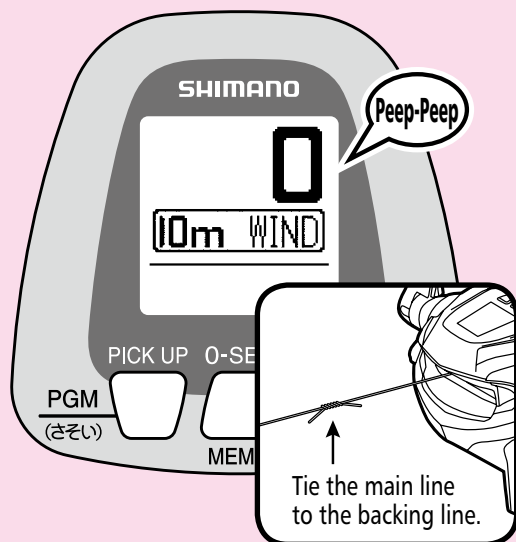

**5** The alarm will sound (peep-peep) and the display will appear as shown in the diagram. Once winding-on is finished, tie the main line to the backing line.

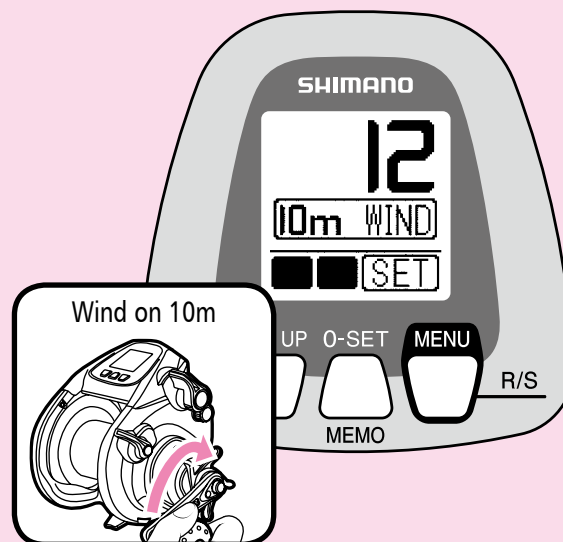

**6** Accurately wind on 10m of main line. The display changes in accordance with the number of spool revolutions.

**Caution:** The values and settings shown on the reel display in this manual are in some cases just examples. Actual values may differ.

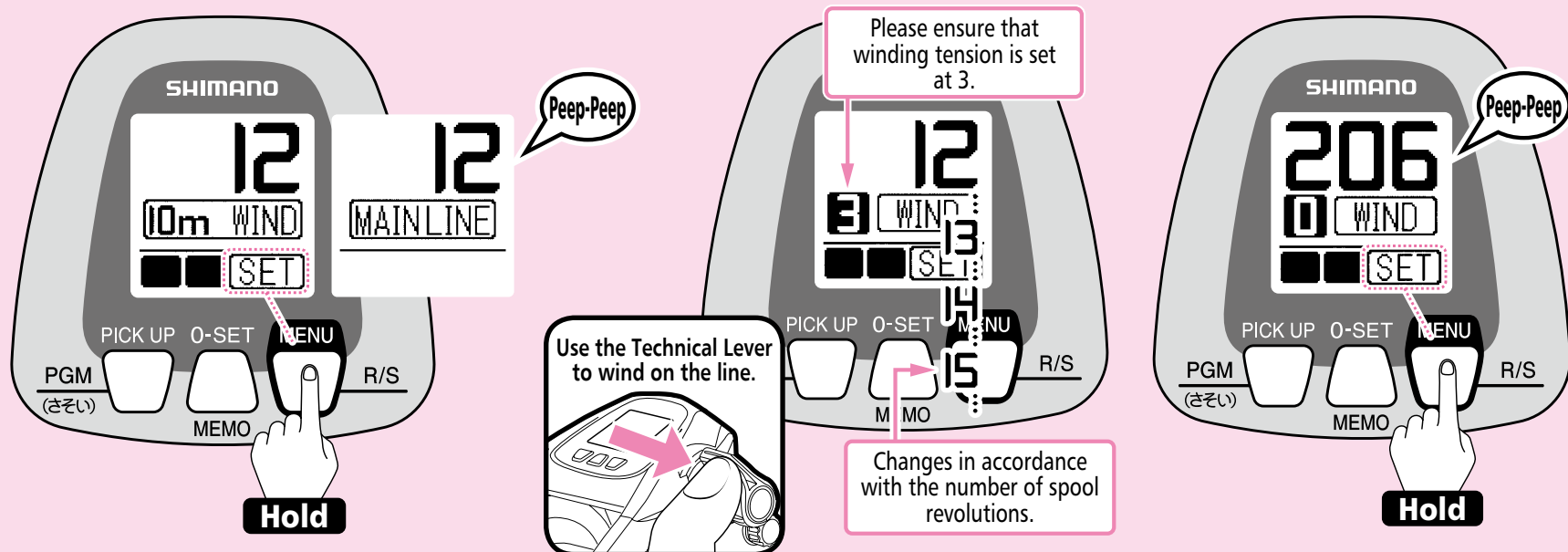

- 7** Press the MENU button for more than 3 seconds.  
The alarm will sound (peep-peep) and the display will appear as shown in the diagram.

- 8** Use the Technical Lever to wind on the line.  
A number corresponding to the number of spool revolutions will be displayed.  
**Operate at a winding tension of 3.**  
This value indicates the force (line tension) applied for winding the reel as a number. The number does not equal kilograms. In addition, it will differ from the value which appears in Rakuraku Mode.  
**When winding using the Technical Lever, the speed can be adjusted using the Technical Lever. To stop winding, set the Technical Lever to the "OFF" position.**

- 9** After completely finishing winding on the line, press the 0 SET button for more than 3 seconds.  
The alarm will sound (peep-peep).

**Note:**  
Do not wind on all of the line. If all of the line is wound on, it will cause an error in the counter value.

**Caution:** The values and settings shown on the reel display in this manual are in some cases just examples. Actual values may differ.

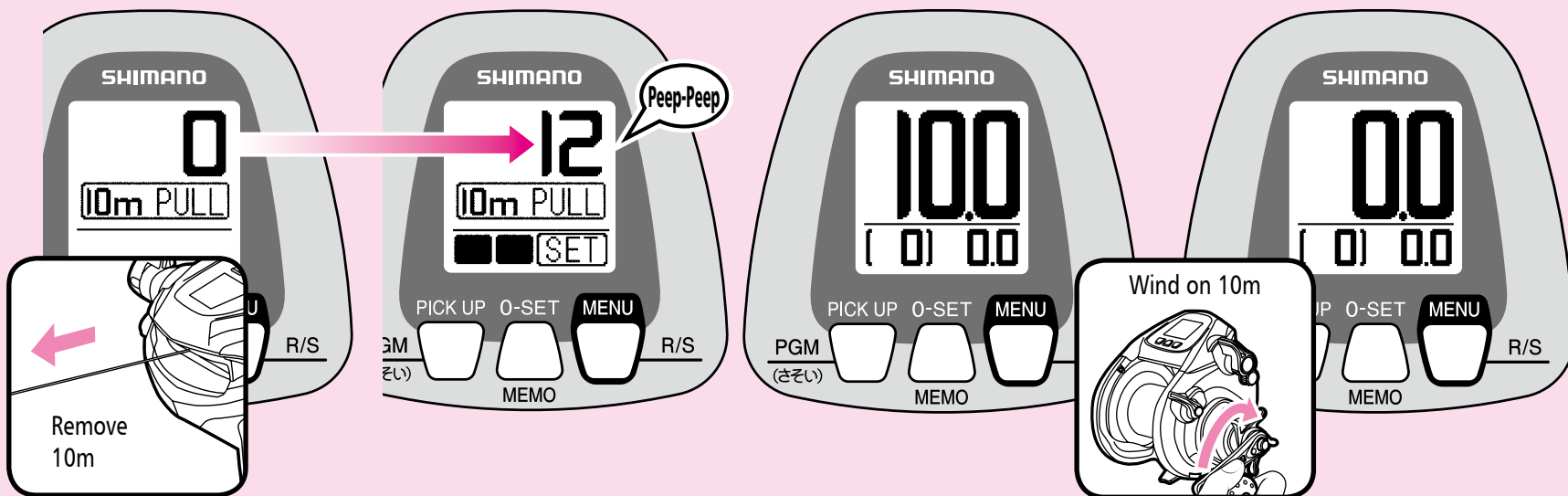

- 10** Accurately pull out 10m of line. (Check the changes in colour every 10m, or the number of marks occurring every 1m.) To finish learning, press the **SET** button for more than 3 seconds. The alarm will sound (peep-peep).

- 11** The display will return to Standard Mode and learning will be complete. (In some cases there may be as much as a  $\pm 3\%$  difference between the counter value and the actual length of the line.)
- \* This difference is the difference in the first cast made after learning.
  - \* After this when actually fishing, if you think that the difference is too great, carry out Line Learning Adjustment as shown on pages 61. This will enable you to position your rig more accurately.

- 12** Wind on the 10m of line that was pulled out.

# What to do after Completing Learning

(Continued on the next page.) →



## Basic

All you need to know in order to use the reel.



Spool Free Mode

## Spool Free Mode



Overwinding Prevention Function

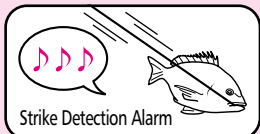

Strike Detection Alarm

Spool Free Mode enables two functions—the Overwinding Prevention Function and the Strike Detection Alarm.

See Pages 59~60 for details.



Reset

## Zero Reset

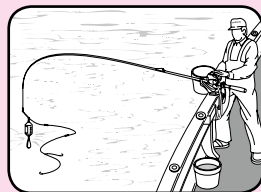

Press one button to Zero your line at the surface.

Now you can accurately position your rig at your target depth.

See Pages 37~38 for details.



Gunwale Stop

## Gunwale Stop

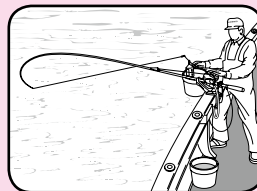

Stops retrieving the line at the point where you can raise the rod vertical and have the rig come straight to your hand.

See Pages 41~42 for details.



Technical Lever

## Technical Lever

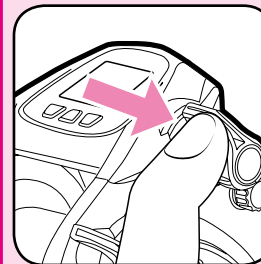

Use the Technical Lever to easily wind in your line when the bait needs to be changed or when you have hooked a fish.

See Page 15, 47~48 for details.



Saved depth

## Saved Depth

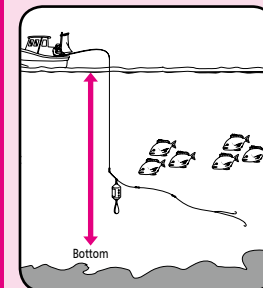

You can store the water depth from the surface or from the bottom, and display it in the Saved Depth column. In Bottom-Up mode, the depth is displayed in the Saved Depth column with the saved position represented by 0.

See Pages 43 for details.



## Convenient

Simple and convenient features.



## Advanced

More advanced features open up a wide range of possibilities.



## Manual mode

When the counter shows 0.0 or less, the motor can be used for winding the line in.

※ When Manual Mode is OFF and the counter shows 0.0 or less, the motor cannot be used for winding the line in. The default setting is OFF.

See Page 49 for details.



## Electronic Drag Sound

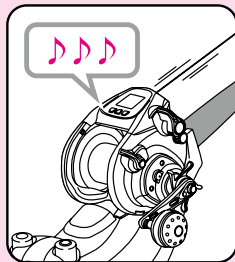

The drag sound is generated electronically. This energizing sound is produced to spur on the angler.



## Pick up

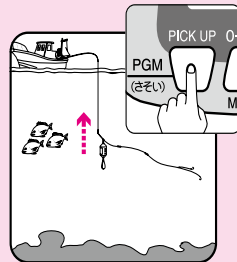

The motor winds in the line for as long as the button is pressed.

See Page 11~13 for details.



## Top-Down Timer

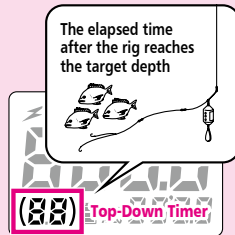

Displays the elapsed time after the rig reaches the target depth from the surface.

See Page 11 for details.



## Rig Retrieval Time

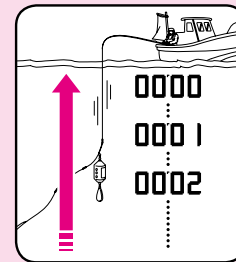

Displays the time remaining for the rig to be retrieved to the gunwale.

See Page 58 for details.



## Lowering Speed Display

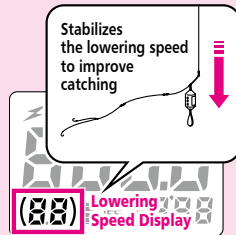

"( )" flashes while the estimated lowering speed is being displayed. Stabilising the lowering speed can assist with improving the success of hooking.

See Page 11 for details.



Electric winding load display

## Electric Winding Load Display

This shows the estimated line tension.

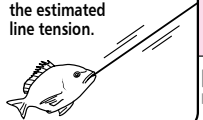

Electric Winding Load Display



This shows the estimated line tension when the motor is winding up the line. Drag adjustment and winding speed adjustment can help prevent the leader from snapping, and are also factors in determining the size and number of fish that can be caught.

See Page 12 for details.



Line Learning Adjustment

## Line Learning Adjustment

Line Marker



Adjust Discrepancies

Counter



Position your rig more accurately by eliminating the discrepancy between actual line markers and the counter on the display.

See Pages 61~63 for details.



Top-Down/Bottom-Up Modes

## Switching between Top-Down mode and Bottom-Up mode

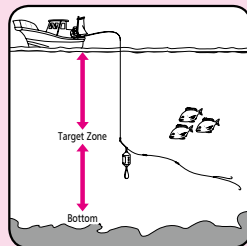

If you would like to check the depth from the bottom in accordance with the fishing location, fishing method and the type of fish being caught, you can change the saved depth display method.

In Top-Down mode, the saved depth is displayed, but if you select Bottom-Up mode, you can check the depth with the saved depth position represented by 0.

See Pages 44~46 for details.



Rakuraku Mode | Fixed Speed Mode

## Change between Rakuraku Mode and Fixed Speed Mode

The spool rotates at a constant speed in **Fixed Speed Mode**.

Switch between Modes

Line tension is constant in **Rakuraku Mode**.

Change between Rakuraku Mode, which maintains a constant tension and prevent line slack, and Fixed Speed Mode, which maintains spool rotation at a constant speed.

See Pages 47~48 for details.



Program Mode

## Program Mode

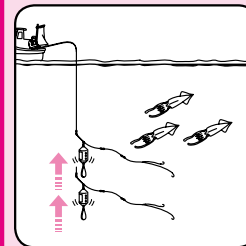

The electric reel can reproduce various movement patterns.

Three movement patterns are available—3 Step, 2 Step, and Repeat—plus a Learning Mode to program/select your own movement patterns.

See Pages 50~57 for details.

# Various Techniques (You will want to learn these techniques to improve your catch.)



## Technique

### Drop Your Rig Quickly

This is an especially effective technique when fishing for squid.

- Normally, the mechanical brake knob is tightened to slightly brake the free rotation of the spool to prevent backlash due to the up/down movement of the vessel.

You can also use the techniques shown below.



- This reel has an Auto Casting Function. The motor automatically starts when the rig is 5m or more past the gunwale stop position and spool resistance is minimized. The motor automatically stops when the clutch is returned.

\* As the motor is in operation during Auto Casting, engaging the clutch will cause the line to be slightly wound in but this is not abnormal.

- Point the tip of the rod downward to reduce guide resistance as shown in the picture on the right.

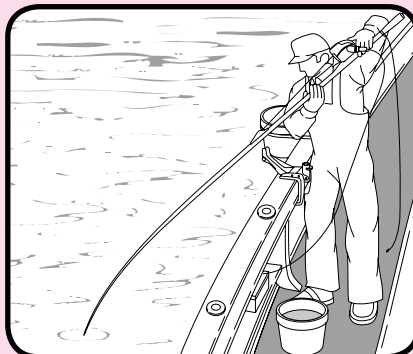
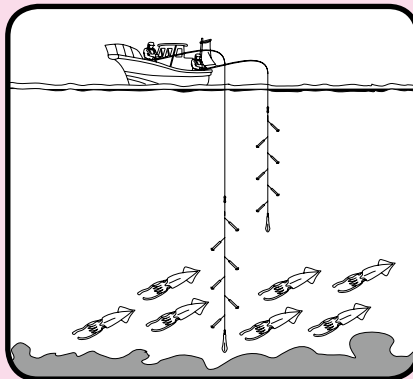

### Turning ON the Auto Casting Function

When you turn the reel ON the Auto Casting Function will be OFF.

1. With the motor stopped and the reel in Standard Mode, press MENU for more than 3 seconds to enter Menu Mode.
2. Select FREE and press MENU.
3. Select ON and press MENU.

Please see Pages 12 for details regarding menu button operation.

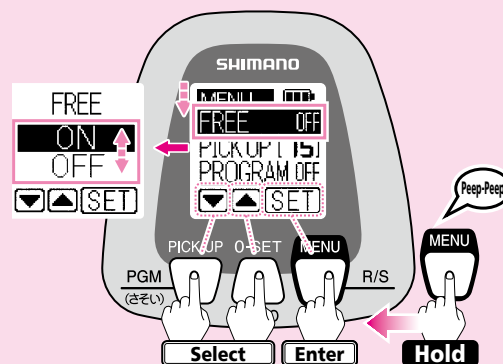



# Zero Setting (Always do this before you start fishing.)

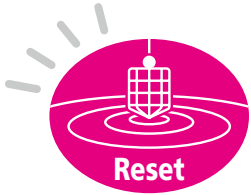

## Accurately reach your target fishing depth.

If you want to improve your catch you must be able to position your rig accurately at the target depth. Zero setting resets the counter to zero when the rig is on the surface.

Zero setting enables you to know the depth of the rig and to accurately position it at the target depth.

- \* Do NOT wind too much line onto the spool as this can cause inaccurate readings when setting zero in one of the Learning Modes.
- \* If you carry out zero setting when the depth display shows 10.1m or more, line breakage compensation will be carried out.

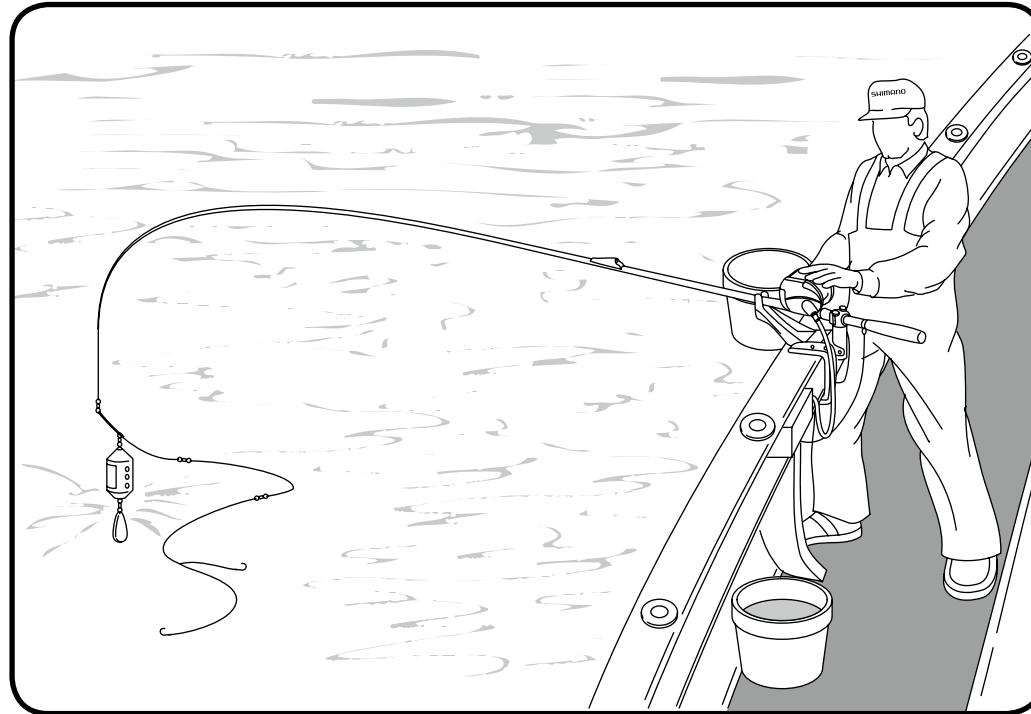

The counter can be reset to 0m when the rig is on the surface.

(Continued on the next page.)

## Let's Try Zero Setting

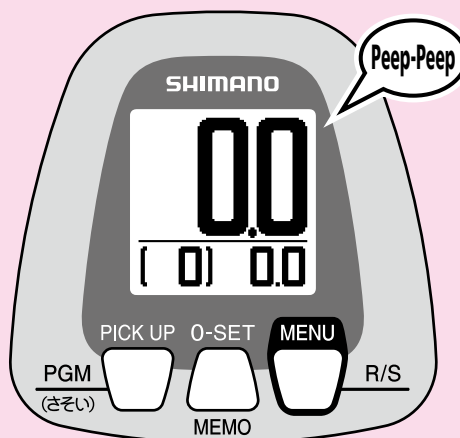

**1** Lower the rig to the surface and press O Set for more than 3 seconds.

**2** The alarm will sound (peep-peep) and the display will change as shown above. Zero setting is complete.

\* It may not be possible to zero the counter if Jigging Mode is ON. Always turn Jigging Mode OFF before zeroing the counter.

### **Caution**

Do NOT wind too much line onto the spool as this can cause inaccurate readings when setting zero in one of the Learning Modes.

# Adjusting Smart Line Depth

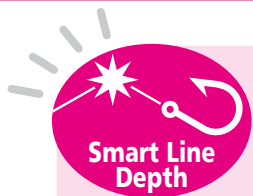

This function allows you to easily return your rig to the same depth after repairing your line if it breaks.

\* If you carry out zero setting when the depth display shows 10.1m or more, line breakage compensation will be carried out.

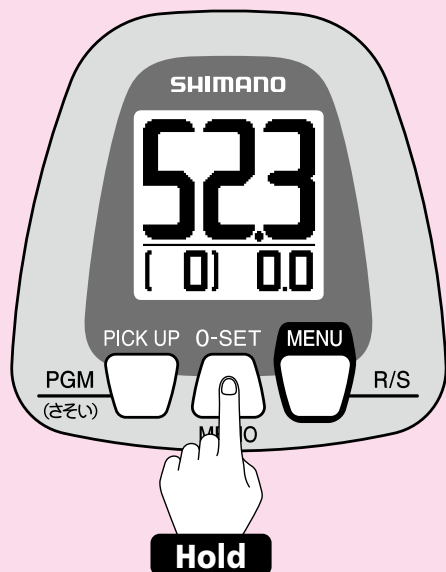

**1** If you break your line, after repairing it, lower your rig to the surface and press 0 Set for more than 3 seconds.

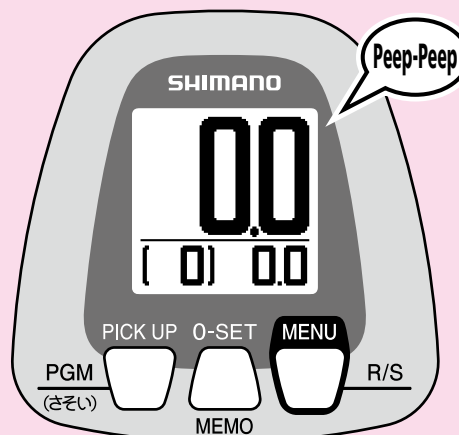

**2** The display will change as shown above. The computer will automatically return your rig to the same depth it was at before the line broke.

## Caution

Do NOT adjust Smart Line Depth with an excessive amount of line wound onto the spool as this can cause inaccurate line learning.

## Caution

Always check that Jigging Mode is turned OFF before adjusting Smart Line Depth. If it is ON and jigging starts, then the line can be wound in and cause unforeseen injuries.



## Shielded Anti-Rust Bearings provide even smoother operation.

A special corrosion-resistant material is applied to the surface of conventional antirust bearings to minimize saltwater penetration and these bearings are located at strategic locations to achieve even smoother performance.

These enable dramatically improved casting performance when fishing for spear squid, as well as improved float fishing performance — something that was said to be difficult to achieve with a powered reel.

This has been made possible by the optimum balance that has been achieved between the safety bar and the level winder, which is the part that is said to cause line tangles when float fishing.

Not only are these bearings resistant to rust, but they also minimize the formation of salt crystals inside the bearings, which can lead to corrosion.

**3 Shielded Antirust Bearings**



# Automatic Gunwale Stop



**When the motor stops, just raise your rod vertical and the rig will come straight to your hand.**

You can set the reel so that when the motor stops retrieving the line you just need to raise your rod vertical to have the rig come straight to your hand.

- \* When connecting to a power source for the first time the Gunwale Stop is set at 6m. From the second time onwards, the position at which the reel is stopped for more than 5 seconds will automatically be remembered by the computer as the Gunwale Stop position. (This feature works within the 1m~6m range. When the depth displayed is less than 1m, in the interests of safety it is set at 1m.)
- \* This product is equipped with a gunwale stop function, so that if the reel determines that large changes are occurring in the load, winding may stop well before the gunwale in the interests of safety. This is a normal part of operation and is not a sign of a malfunction.

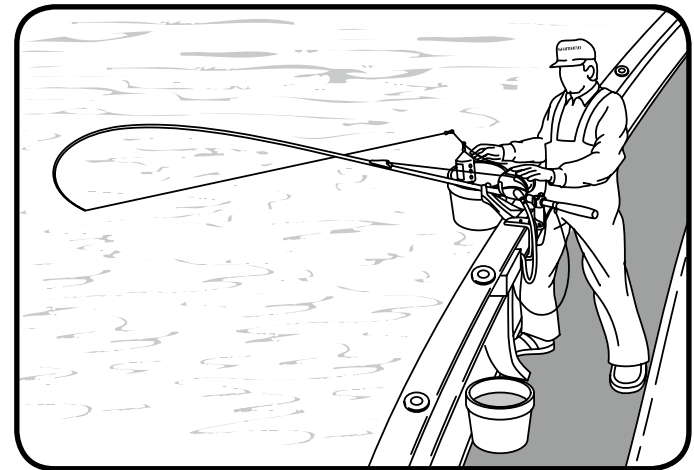

## Helpful Advice

When fishing with a short rod from the bow of a boat, if zero setting is carried out in the normal way, then the Gunwale Stop Position will be outside of the normal 1~6m range.

In such cases, wind the rig up to the end of the rod and reset zero at that point to ensure that when the motor stops the rig will come to your hand when you raise the rod vertical.

In this particular situation, as zero setting is not carried out on the surface of the water, the actual distance from the end of the rod to the surface of the water will be different.

# Alarm (Gunwale)

The alarm will sound 4m before the Gunwale Stop Position.

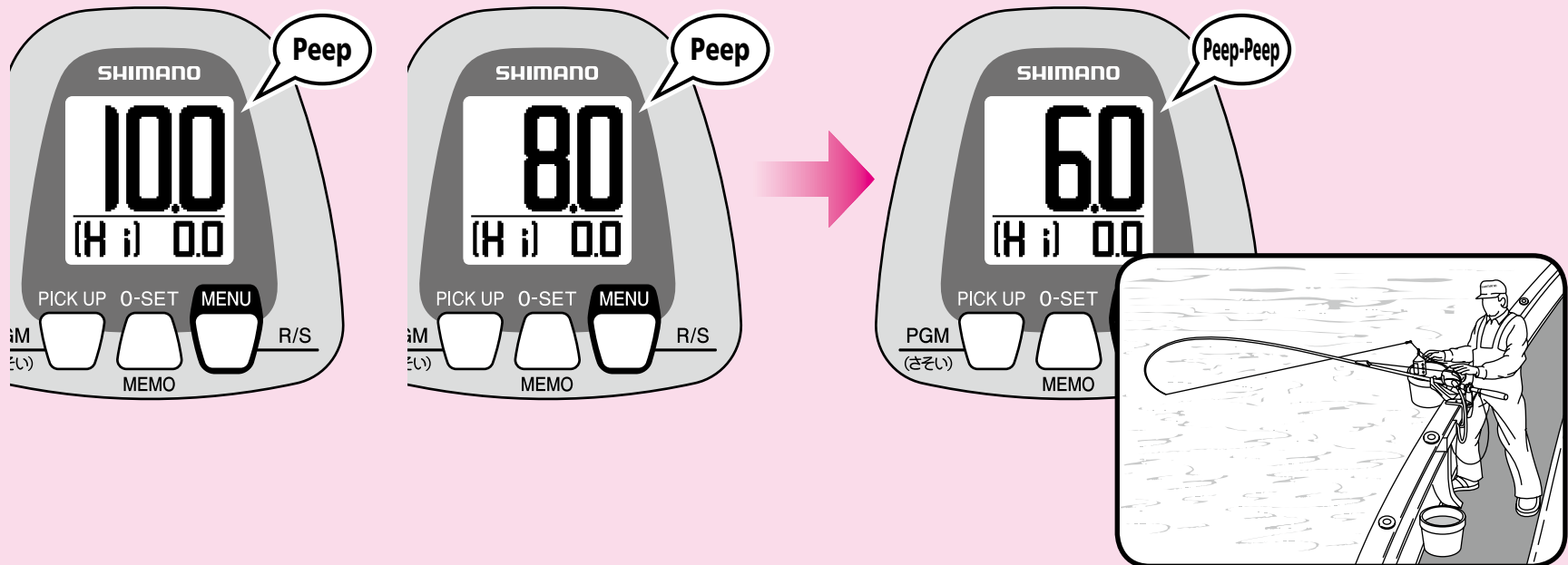

**1** 4m before the Gunwale Stop Position the alarm will sound every 2m. The diagram above shows the display when winding in using the Technical Lever in HI.

**2** At the Gunwale Stop Position (in this case at 6.0m) the alarm will sound (peep-peep) and the motor will automatically stop. After the motor has stopped you can raise the rod vertical and have the rig come straight to your hand as shown in the diagram above.

# Programming Target Depth and Bottom Depth



To save the water depth . . .

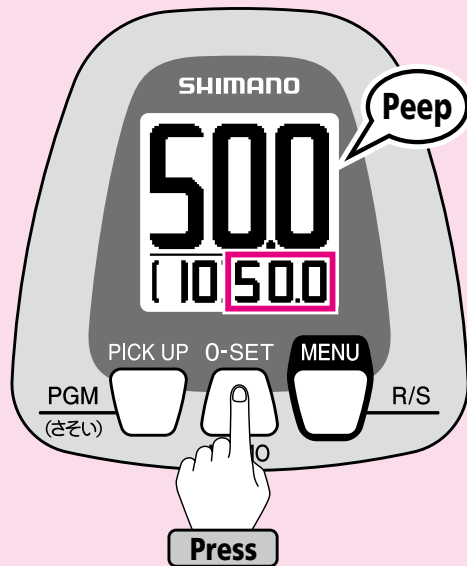

Lower the rig to the desired water depth, and then press the **MEMO** button.

The saved water depth will be displayed in the Saved Depth column. (  section)

In the above diagram, a water depth of 50.0m has been saved.

(When Top-Down Mode is selected)

\* This setting can be repeated as many times as desired.

# Finding the Target Depth



## Choose between Top-Down and Bottom-Up Modes

The secret to improving your catch is being able to accurately position your rig at the depth where the fish are.

With the latest high-performance fish finders it is possible to see the exact depth that the fish are at. The skipper of the vessel will normally give you this information.

Depending on factors such as fishing ground,

fishing technique and target species, this position may be given as the distance from the surface or the distance from the bottom.

This product lets you switch the depth display method for times when you would like to check the distance from the bottom.

Select between modes according to the situation at hand.

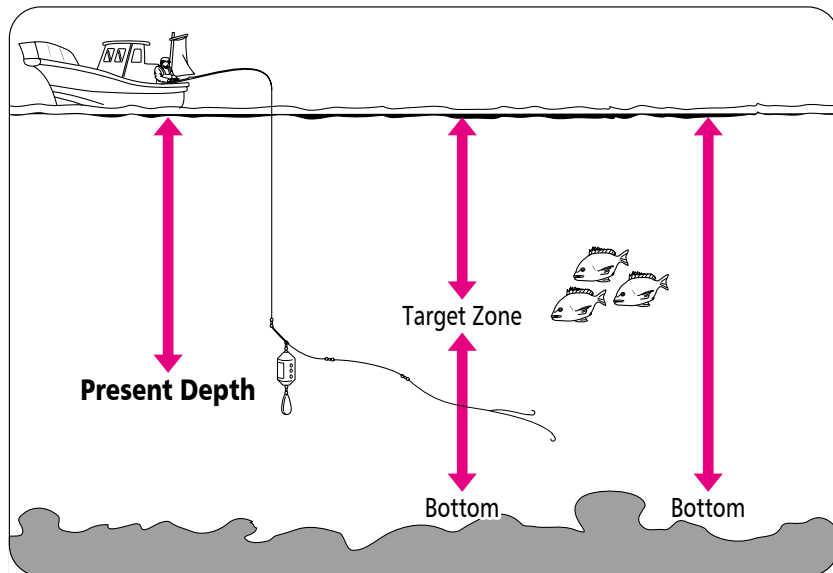

## Changing Mode

When the power is turned ON the reel will be in Top-Down Mode. Use the procedure shown below to change modes.

1. At the Water Depth Display press and hold the **MENU** button for 3 seconds and the Menu Screen will appear.
2. Press ▼ several times and select TOP/BTM. The current setting appears to the right of the function name.  
(Setting shown here is for instructional purposes only.)  
Press SET and the TOP/BTM menu will appear.
3. Use ▼ ▲ to choose either Top-Down or Bottom-Up, then press SET.

Please see Pages 12 for details regarding menu button operation.

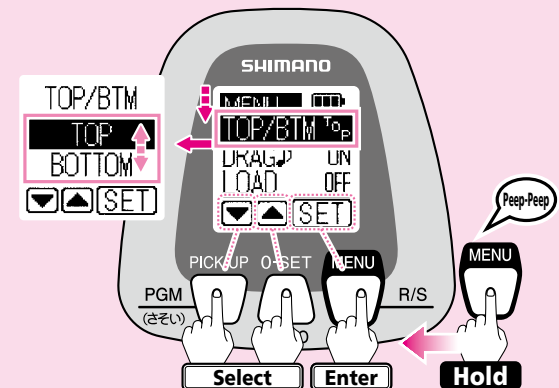



# Top-Down Mode Example

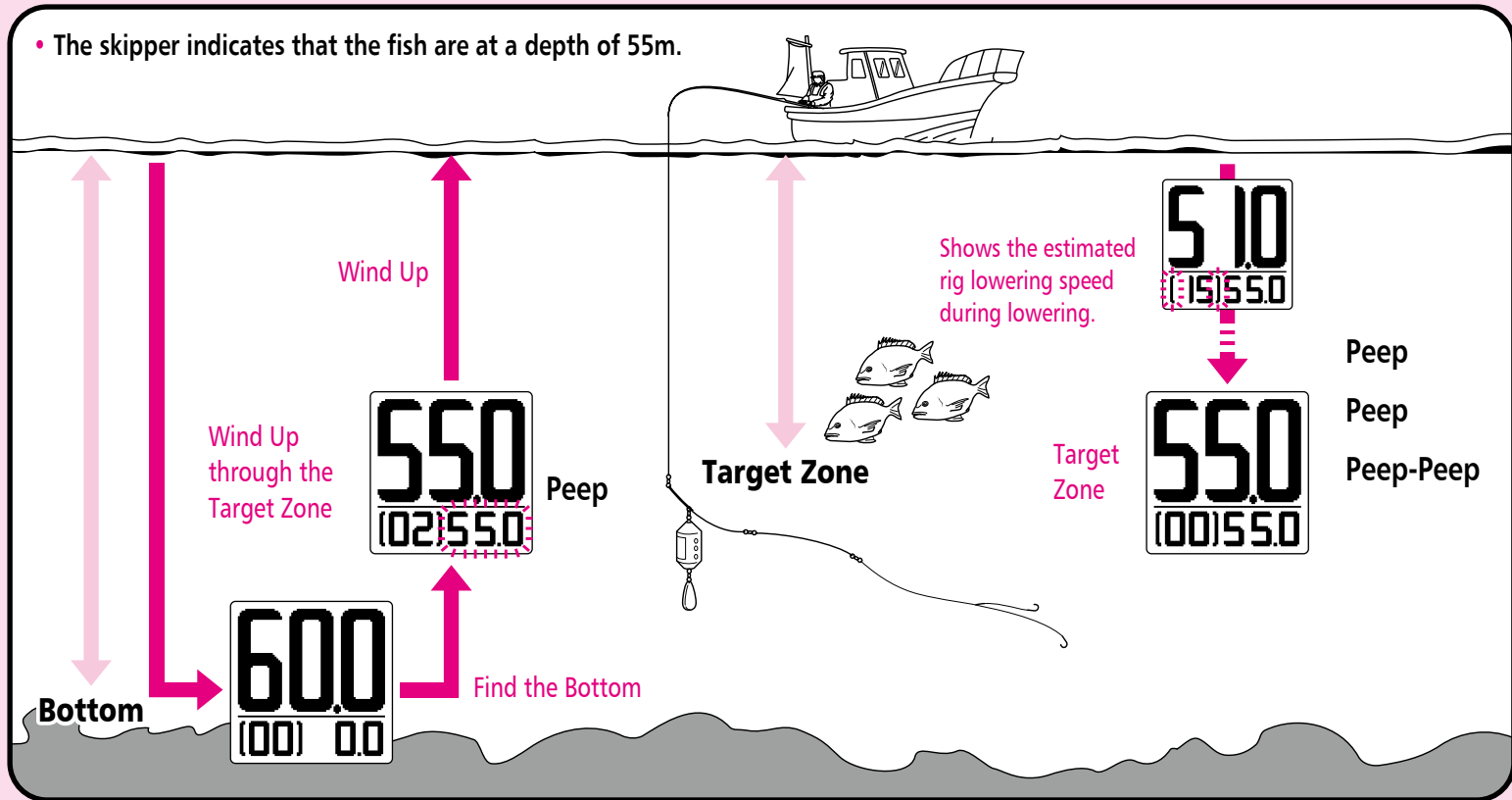

- 1** Allow the rig to drop to the bottom.
- 2** Wind the rig up to the target depth. Press MEMO to save the target depth. The above procedure is used when you want to know the depth of the bottom. However, it is also possible to drop the rig to the target depth and then press Memo to save that depth.
- 3** On subsequent drops the alarm will sound when the rig reaches the saved depth.



# Winding In: Rakuraku Mode | Fixed Speed Mode



## 1 Changing between Rakuraku Mode and Fixed Speed Mode

- Press Menu (R/S) to change between Rakuraku Mode and Fixed Speed Mode.  
You can change modes when winding in.
- The current mode is shown on the display.  
**R** (Rakuraku Mode): Green backlight.  
**S** (Fixed Speed Mode): Orange backlight.

## 2 What is Fixed Speed Mode?

Regardless of the size of the fish, or in other words the load on the reel, Fixed Speed Mode adjusts motor settings to wind in your fish at a set speed\*.

\* Speed is the spool rotation speed.

**Caution:** Settings 1~4 are for dead slow. At some tension setting the weight of the sinker can stop the rig from being wound in. In such cases increase the tension.

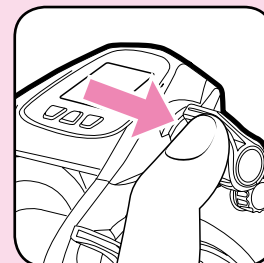

### Technical Lever

Used to set Fixed Speed Mode and Rakuraku Mode.

Shows the position of the Technical Lever.

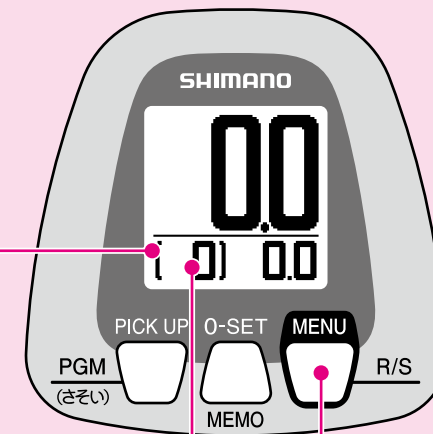

### Present Mode

**R** (Rakuraku Mode): Green Backlight  
**S** (Fixed Speed Mode): Orange Backlight

### Menu | R / S (Rakuraku/Fixed Speed) Button

Used to change between Rakuraku Mode and Fixed Speed Mode.

(Continued on the next page.)

### 3 What is Rakuraku Mode?

Rakuraku Mode maintains line tension at the level you set. In other words, the reel senses the tension (load) on the line and automatically adjusts motor rotation speed to maintain a constant tension.



**In other words...**

<ul style="list-style-type: none"><li>• It avoids the tug of war that occurs between the motor and the fish.</li></ul>	<ul style="list-style-type: none"><li>• This is particularly useful when fishing in rough water where it is impossible to maintain a constant tension on the line manually by using the rod.</li></ul>
<ul style="list-style-type: none"><li>• It adjusts motor speed to compensate for sudden changes in tension caused by the movement of the fish and the vessel.</li></ul>	<ul style="list-style-type: none"><li>• The motor takes up any sudden slack in the line when tension decreases due to factors such as when the rod is lowered during pumping.</li></ul>
<p><b>It makes reeling your fish in so easy that you just need to enjoy your fishing.</b></p>	

### It also has the following advantages...

- Rigs with only a light load can be recovered at maximum speed without having to worry about adjusting motor speed, which makes life easy and means that you can concentrate on fishing.
- Adjust tension can quickly and easily using the Technical Lever.
- Maximize rig strength by eliminating the tug of war that occurs between the motor and the fish.

### Setting Rakuraku Mode

- Settings are adjusted using the Technical Lever (see the previous page for details).
- Settings **1~4** are for dead slow. At some tension setting the weight of the sinker can stop the rig from being wound in. In such cases increase the tension.

# Manual Mode

000

Manual mode

## Handy for Kite Fishing

When the counter shows 0.0 or less, the motor can be used for winding the line in.

Manual Mode can be switched ON or OFF following the instructions below.

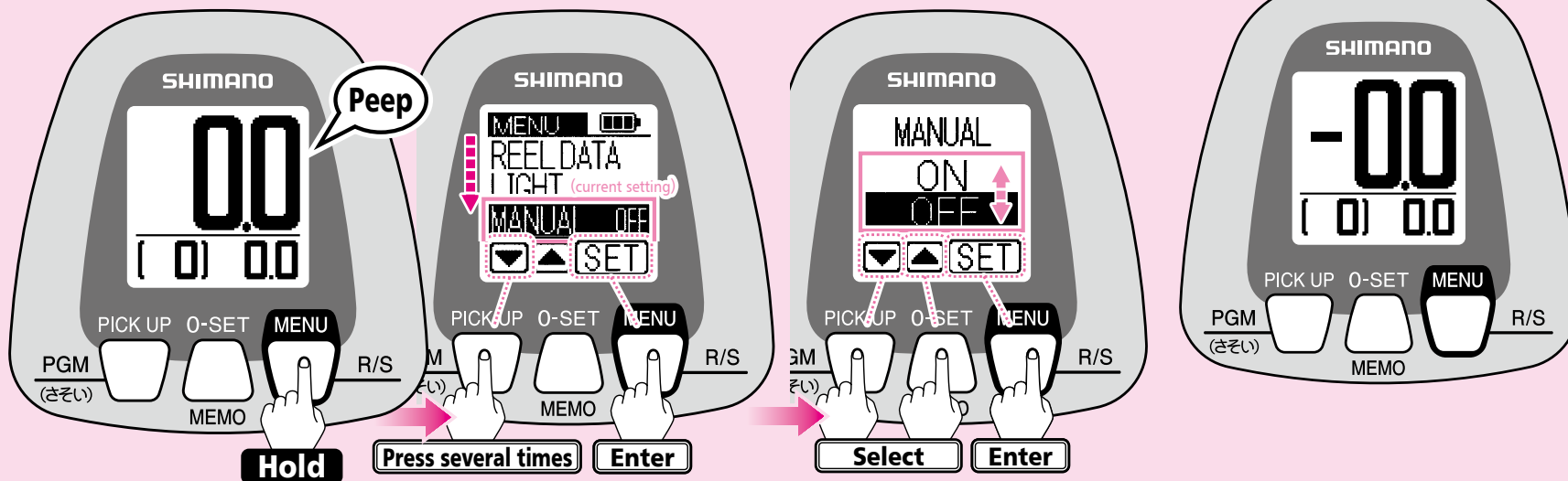

**1** When the power is turned on, Manual Mode is set to OFF. The illustration shows the Water Depth Display with Manual Mode OFF.

At the Water Depth Display press and hold the **MENU** button for 3 seconds and the Menu Screen will appear.

Note: All settings and values shown here are for instructional purposes only. They are not intended to be actual settings or values.

**2** Press **▼** several times and select **Manual Mode**.

The current setting appears to the right of the function name.

(Settings shown here are for instructional purposes only.)

Press **SET** and the Manual Mode menu appears.

Use **▼▲** to choose either **ON** or **OFF**, then press **SET** to complete the setting.

(See pages 12 for details regarding Menu Screen operation.)

If you set the Manual Mode to ON, you can use electric reeling when the counter shows 0.0 or less.

# Program Mode



Replicates pro-angler reeling patterns or your own programmed technique

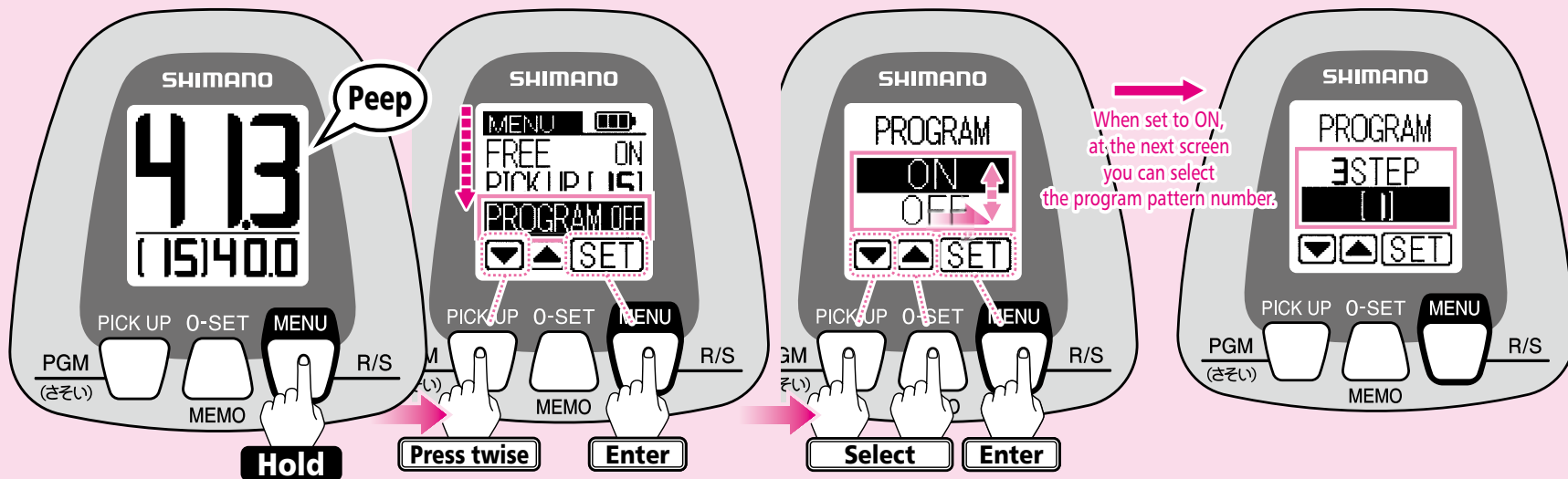

- 1** When the power is turned on, Program Mode is set to OFF.

At the Water Depth Display press and hold the MENU button for 3 seconds and the Menu Screen will appear.

Note: All settings and values shown here are for instructional purposes only. They are not intended to be actual settings or values.

- 2** Press ▼ twice to select PROGRAM.  
The current setting appears to the right of the function name.  
(Settings shown here are for instructional purposes only.)  
Press SET and the Program menu appears.  
Use ▼▲ to choose either ON or OFF, then press SET.  
(See pages 12 for details regarding Menu Screen operation.)

- 3** When set to OFF, you will return to the Menu Screen and the setting is complete.  
When set to ON, at the next screen you can select the program pattern number.  
Program patterns 1–3 are preset patterns as described on the opposite page, while 4 and 5 you can program with your own techniques.  
Patterns 4 and 5 are factory set at dead slow winding. You can overwrite these by programming in a new pattern.

### [1] ... 3 STEP Mode

Winds at speed 28 of Fixed Speed Mode.

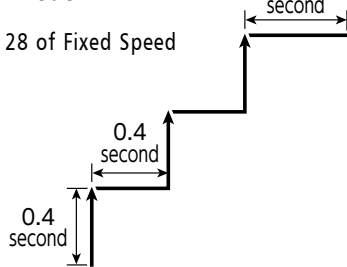

### [2] ... 2 STEP Mode

Winds at speed 28 of Fixed Speed Mode.

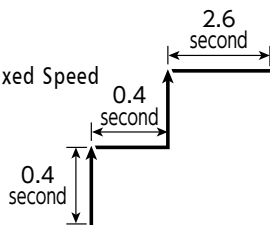

### [3] ... STEP Repeat Mode

Winds at speed 16 of Fixed Speed Mode.

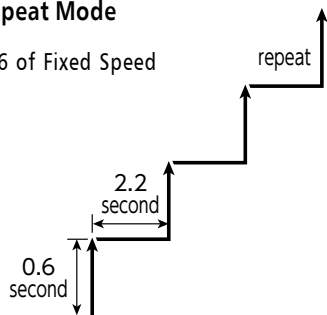

### [4] • [5] ... Custom Repeat Mode

Note: All values shown on the counter are for instructional purposes only. They are not intended to be actual values.

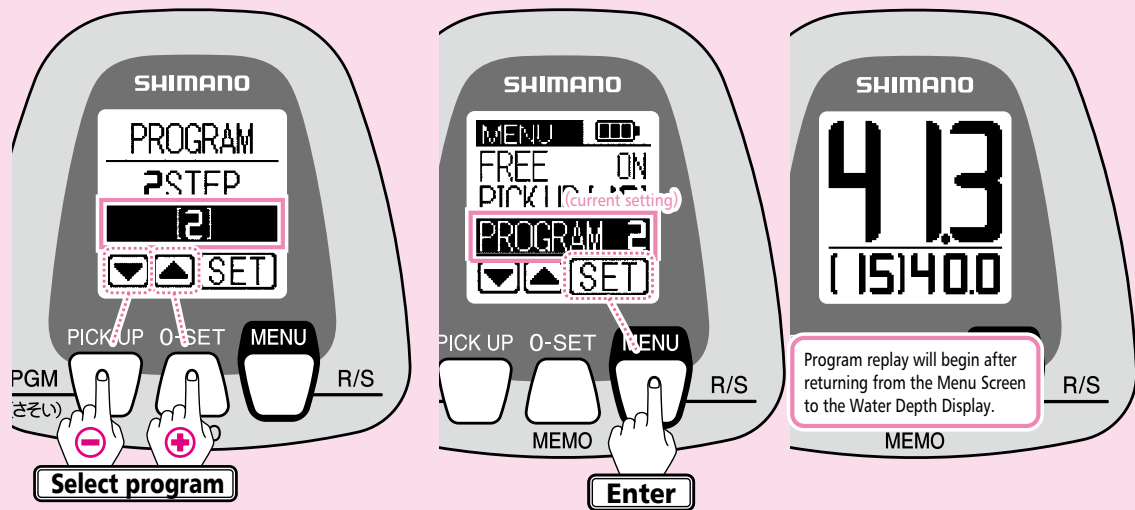

### 4 Use ▼ ▲ to select program pattern number.

※ Caution

The preset program patterns are typical patterns, but the movements will depend on actual conditions such as the rod, weights, water depth, etc. If the presets do not suit the angling conditions, it is recommended that you program your own pattern and use it instead.

If you select pattern 4 or 5, proceed to the next page in this manual and follow the instructions for Program Learning.

### 5 Press SET to complete the setting and return to the Menu Screen.

(Illustration shows program pattern set at 2.)

Select RETURN from the Menu and return to the Water Depth Display.

The reel will then be ready to replay the programmed movement pattern.

To start the program pattern, see page 55 "Using the Program Mode"



## Replicate Your Own Original Jigging Technique.

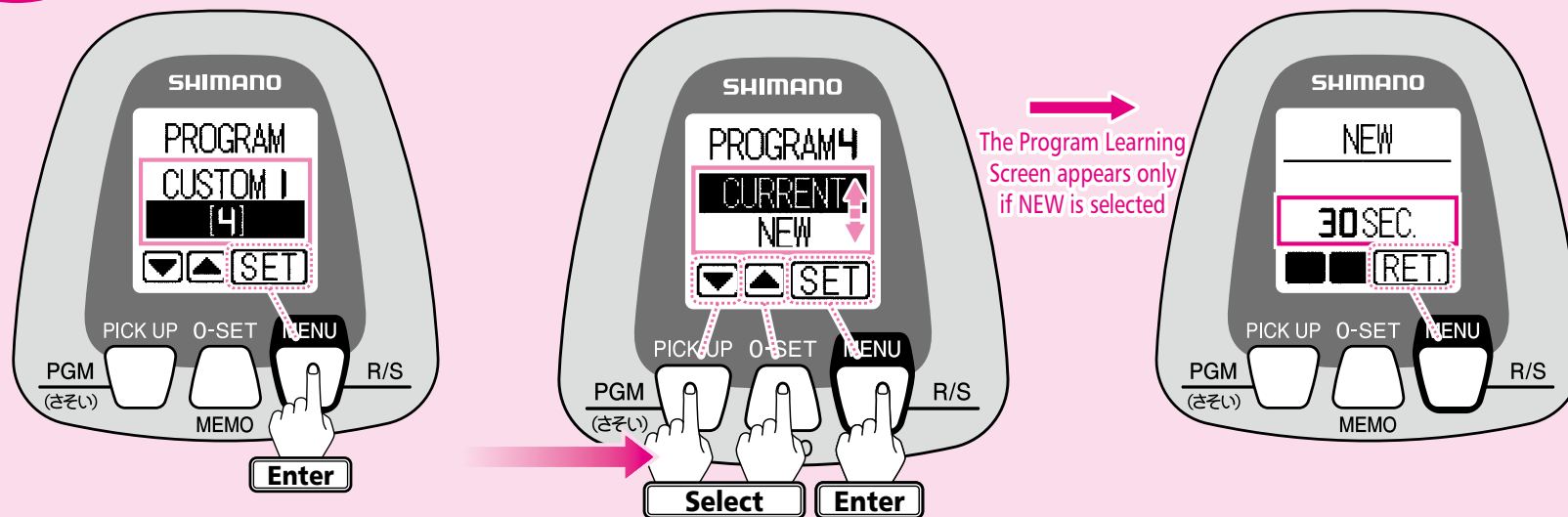

### 1 Choose pattern 4 or 5 and press SET.

Note: All settings and values shown here are for instructional purposes only. They are not intended to be actual settings or values.

### 2 The next menu will appear.

To select a pattern that you have already programmed in 4 or 5, set to **CURRENT**, or if you want to overwrite with a new pattern, choose **NEW** and press SET.

When set to ON, you will return to the Menu Screen and the reel is ready for program replay.

### 3 Jigging Learning can be carried out for a maximum of 30 seconds.

The time remaining to record your jigging technique will be displayed on the lower right of the display.



**Caution:** The settings and values shown on the display are for illustration purposes only. Actual settings and values may differ.

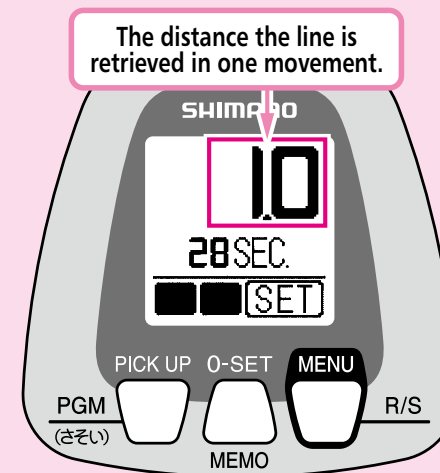
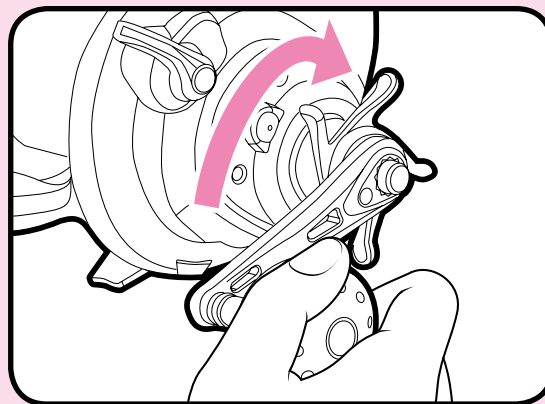
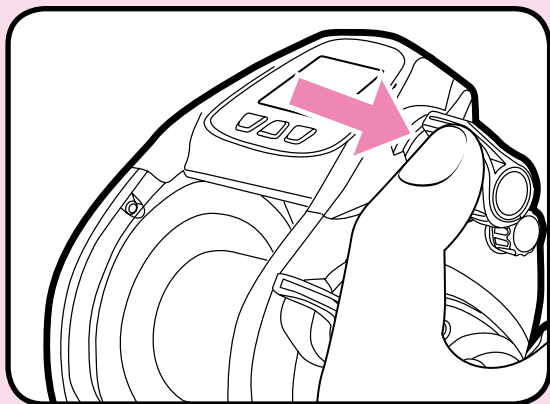

### ● Learning Using the Handle

Turn the handle at the desired speed and then rest for as long as you want.

If you take too long to turn the handle (more than 2 seconds for a single turn) then this will not be recorded.

If the spool turns faster than the maximum speed using the Technical Lever, then this will be recorded as the maximum speed for the Technical Lever.

### ● Learning Using the Technical Lever

Retrieve the line at the speed and timing you desire and then rest for as long as you want.

This is only possible in Fixed Speed Mode.

### 4 Review the technique (winding and rest times) recorded using the Technical Lever or the handle.

Learning starts when winding begins and at the same time the number of seconds remaining is shown on the display.

The distance the line is retrieved in one movement is shown in the center of the display.

(Continued on the next page.)

**Caution:** The values and settings shown on the reel display in this manual are in some cases just examples. Actual values may differ.

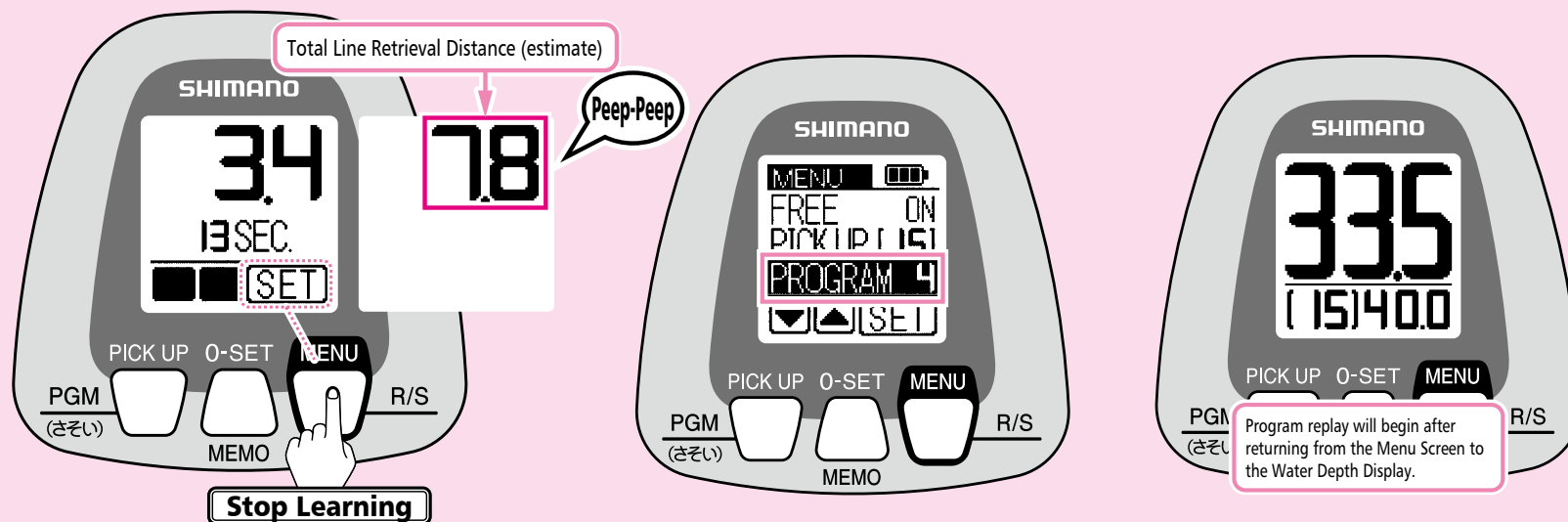

**5** Press MENU to stop Learning.

If MENU is not pressed then Learning will automatically stop after 30 seconds.

After Jigging Learning has stopped the total line retrieval distance (estimate) is displayed in the center of the display for 2 seconds as shown above.

**6** The display will return to Standard Mode

\* If you input a new technique in Jigging Learning then the old data will be erased. If you want to redo Jigging Learning then go back and repeat the process from the beginning.

The reel is now ready to use in Jigging Mode with your own original jigging technique.

(Continued on the next page.)

Select RETURN from the Menu to return to the Water Depth Display.

# Using the Program Mode



Finally, try out the program pattern that you have set.

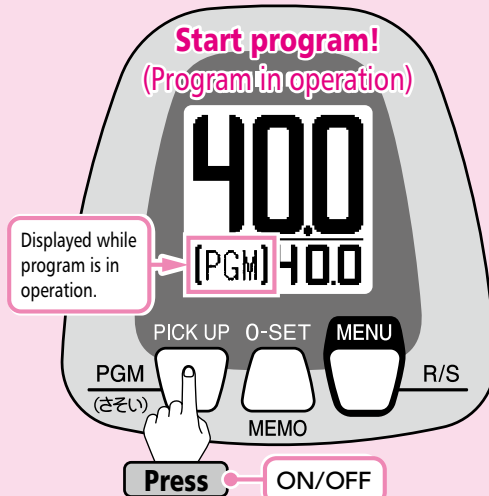
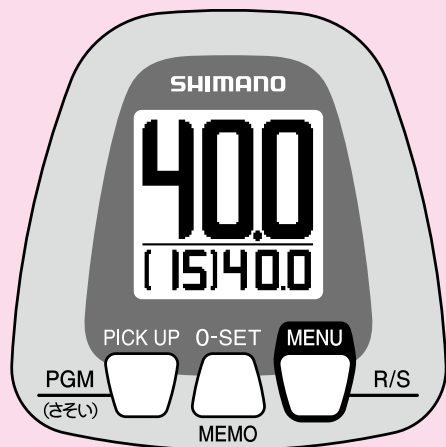

- 1** Set Program Mode to ON, referring to pages 50–54.

If the Menu Screen is displayed, select RETURN to switch to the Water Depth Display.

Note: All settings and values shown here are for instructional purposes only. They are not intended to be actual settings or values.

- 2** Lower the rig to the target depth and press the PGM button to repeatedly perform the saved program pattern.

While the program pattern is in operation, [PGM] will be displayed on the Water Depth Display.

※ When Program Mode is ON, Pick Up Mode is automatically turned OFF.

To pause and restart the program pattern, press the PGM button.

※ After gunwale stop, the motor stops.

(Continued on the next page.)

**Caution:** The values and settings shown on the reel display in this manual are in some cases just examples. Actual values may differ.

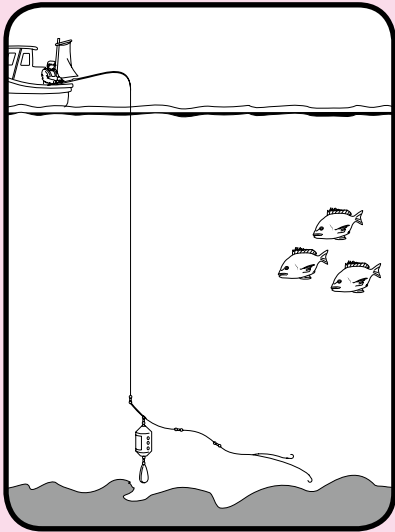

**Press the PGM button.  
Program pattern  
starts!**

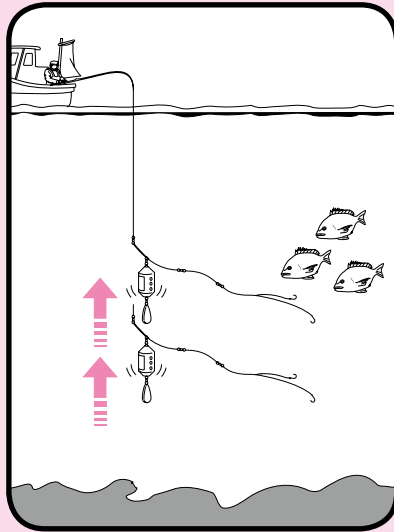

**Program in  
operation**

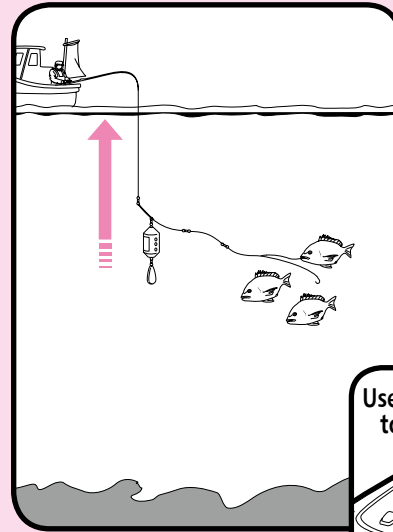

**Strike! Reel in!**

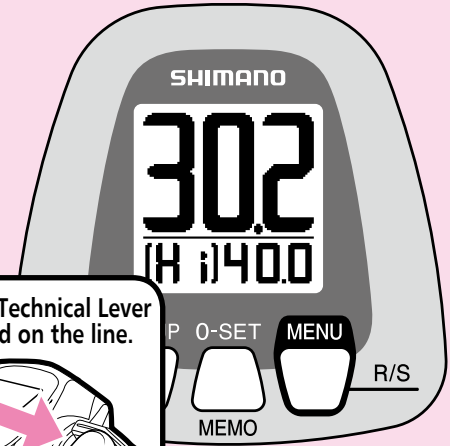
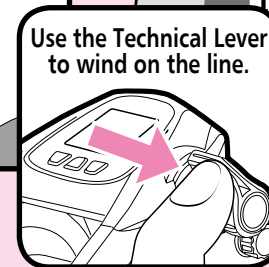

**3** If there is a strike, use the Technical Lever to reel the fish in.

※ Once rig retrieval is started using the Technical Lever while the program pattern is running, the program will stop and priority is given to reeling in.

**With the fish landed, lower the rig and restart the program pattern again.**

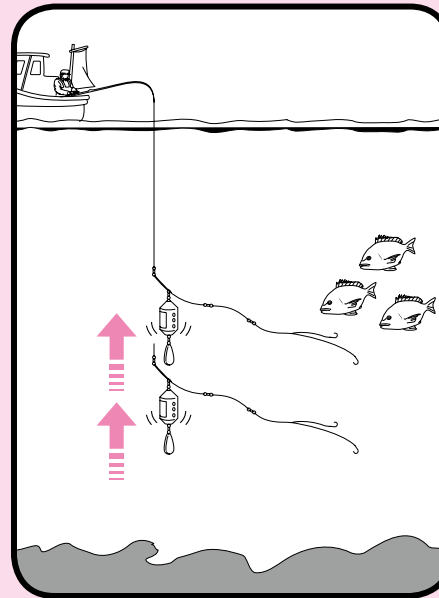
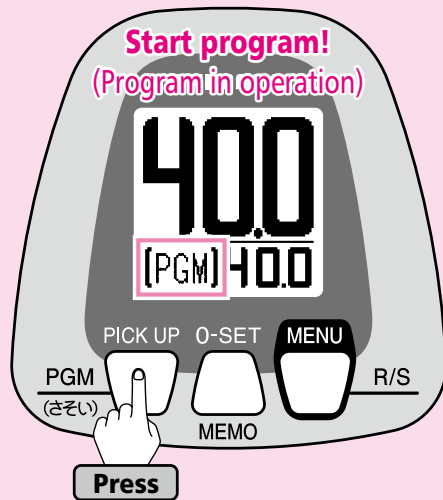

**Press the PGM button.  
Program pattern starts again!**

**4** After rig retrieval and gunwale stop, if you want to continue with the same programmed motion, lower the rig to the target depth again.

If you want to change the pattern, set the program from the Menu Screen.

After lowering the rig, press the PGM button and the previously saved action will be repeated.

# Rig Retrieval Time



When retrieving the rig under power, this displays the time remaining for the rig to be retrieved to the Gunwale Stop Position.

Use the procedure shown below to turn ON this function.

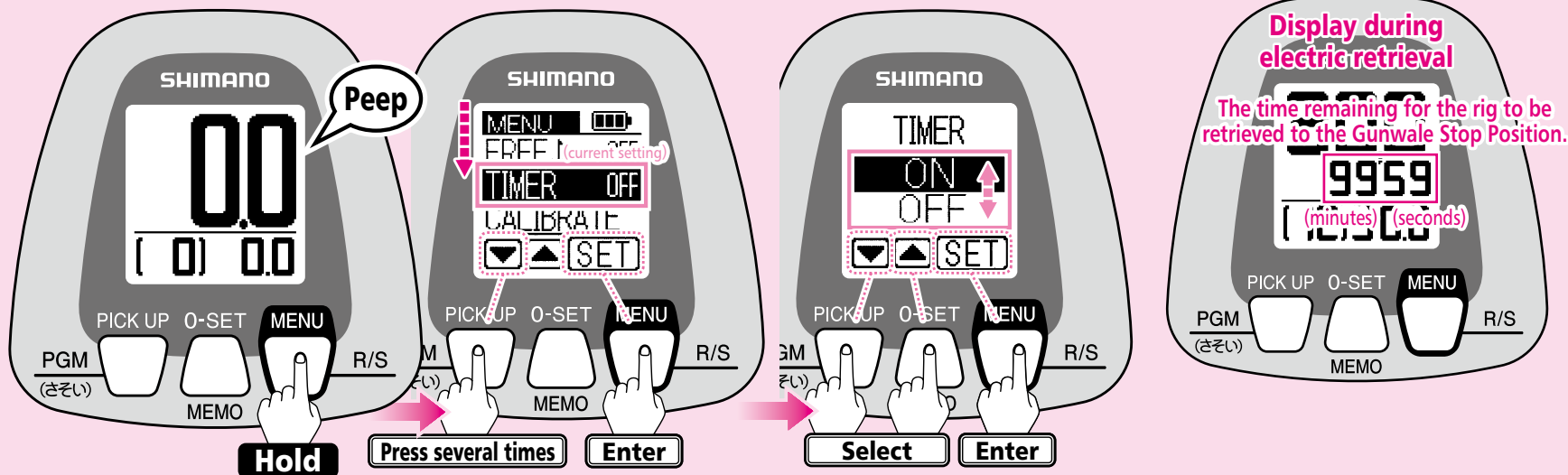

**1** When the power is turned on, Rig Retrieval Time is set to OFF. The illustration shows the Water Depth Display with Rig Retrieval Time OFF.

At the Water Depth Display press and hold the **MENU** button for 3 seconds and the Menu Screen will appear.

Note: All settings and values shown here are for instructional purposes only. They are not intended to be actual settings or values.

**2** Press ▼ several times and select **TIMER**.

The current setting appears to the right of the function name.

(Settings shown here are for instructional purposes only.)

Press **SET** to display the Rig Retrieval Time menu.

Use ▼▲ to choose either ON or OFF, then press **SET** to complete the setting.

Please see Pages 12 for details regarding menu button operation.

When retrieving the rig under power, this displays the time remaining for the rig to be retrieved to the Gunwale Stop Position. The display can show a maximum of 99'59 (99 minutes and 59 seconds). For times longer than that the display will flash 99'59.



## Prevents rig from winding up into tip and alerts you to a strike

Spool Free Mode enables two functions—the Overwinding Prevention Function and the Strike Detection Alarm.

### 1 *Overwinding Prevention Function*

When free-spool fishing or engaging in other types of low-load angling, the load varies greatly depending on whether a fish is on the line or you are simply retrieving the rig.

Winding learning on an electric reel records the number of rotations at a specific load, so that a large fluctuation in load causes a large error. When a nylon or fluorocarbon line is used together with a line with high elastic stretch, the error becomes even greater. Sometimes the rig will get wound up into the rod tip and may damage the tip.

With Spool Free Mode ON, a program runs to prevent entanglement in the tip, allowing you to relax and safely enjoy fishing. When this program detects a high load on the reel when retrieving the rig, it sets the gunwale stop position at 6m. When the detected load is light, the gunwale stop position is set at 10% of the line length that has been sent out (10m for a 100m line, or 6m at a minimum).

※ Whichever is activated, the numbers shown on the counter will become slightly off from the actual meter count. This function will turn on at a speed of 20 or higher; the rig can sometimes get entangled in the tip when winding up with light loads at speeds of less than 20.

### 2 *Strike Detection Alarm*

When the line is let out with the clutch OFF, if the line is drawn faster than the set speed, the strike alarm will beep repeatedly for 3 seconds, notifying you of a strike. You can also change the value of this setting. The default setting is OFF.

- ※ When the motor is off, this function takes effect when the counter display is 20m or higher.
- ※ To change the set speed, on the Menu Screen turn Spool Free Mode ON and the settings screen will appear. (See next page.)

## To turn Spool Free Mode ON/OFF or set the Strike Detection Alarm speed

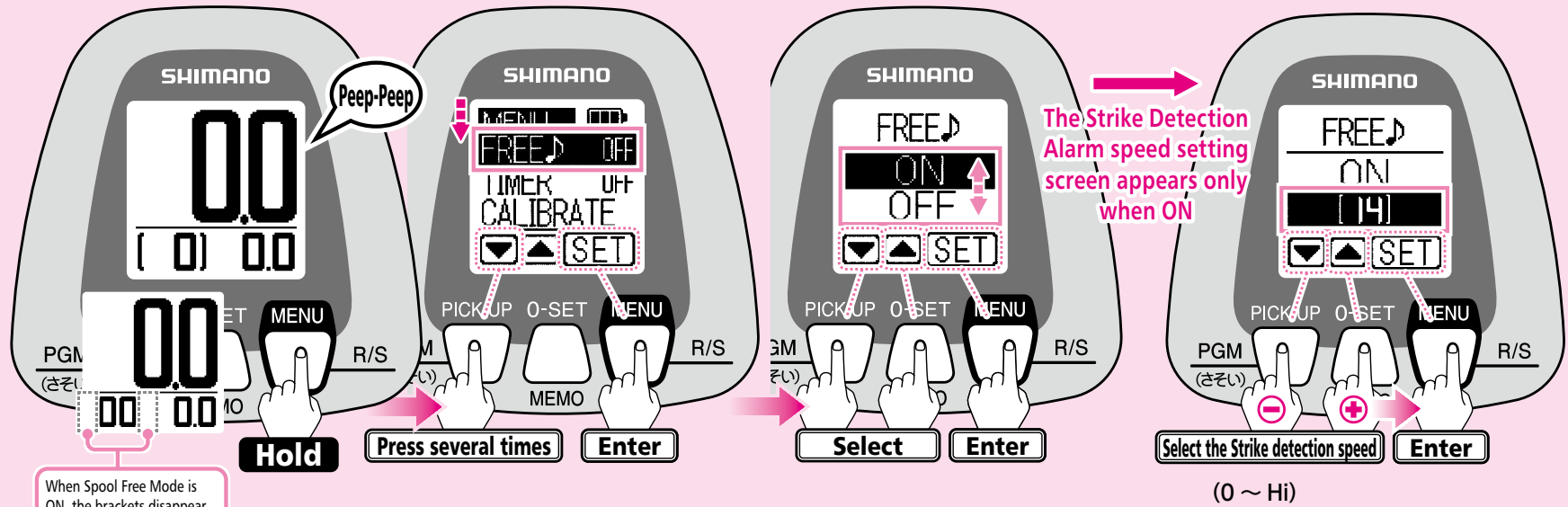

- 1 When the power is turned on, Spool Free Mode is set to OFF. After "Fluoro Learning Mode E2" for Line Learning is completed, Spool Free Mode turns ON automatically.

※ When Spool Free Mode is ON, the brackets on the Water Depth Display disappear.

At the Water Depth Display press and hold the **MENU button** for 3 seconds and the Menu Screen will appear.

Note: All settings and values shown here are for instructional purposes only. They are not intended to be actual settings or values.

- 2 Press **▼** several times and select **FREE** .

The current setting appears to the right of the function name.

(Settings shown here are for instructional purposes only.)

Press **SET** to display the **FREE**  menu.

Use **▼▲** to choose either ON or OFF, then press **SET**.

(See Pages 12 for details regarding Menu Screen operation.)

- 3 When set to OFF, you will return to the Menu Screen and the setting is complete.

**Only when set to ON will the screen appear for setting the Strike Detection Alarm speed.**

### Set the Strike Detection Alarm Speed

Use **▼▲** to increase or decrease the speed, then press **SET**.

※ Can be set from 0 to Hi. (Default setting is 14.)



# Line Learning Adjustment

Line Learning Adjustment

Set the target depth more accurately by correcting the discrepancy between the depth shown on the display and the markings on the line.

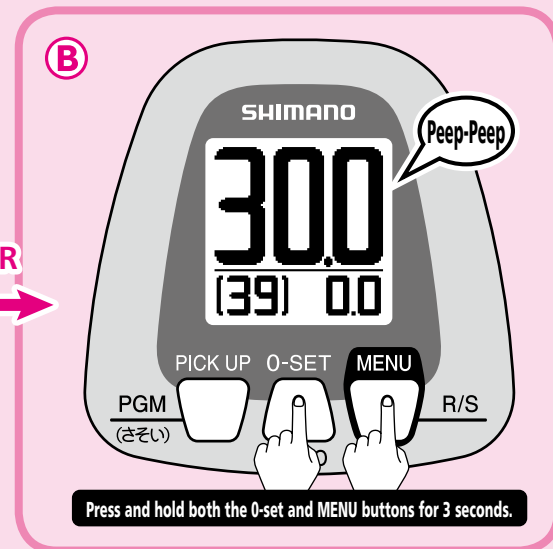
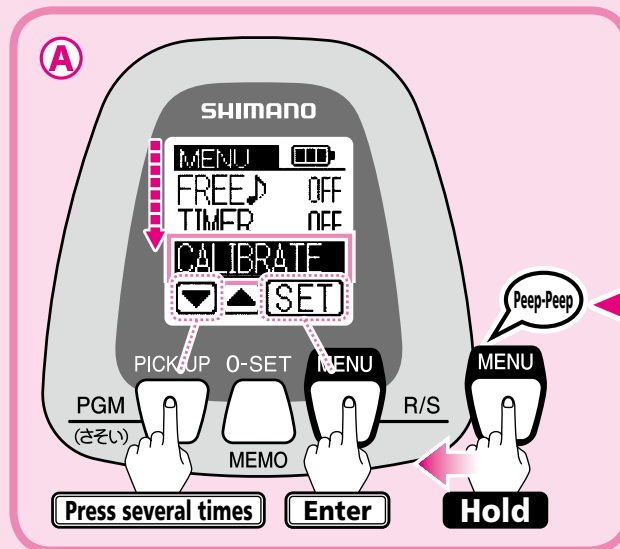
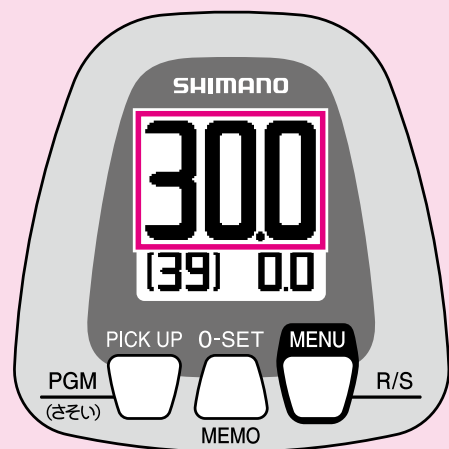

- 1 Effective at a depth of more than 10m. Round up the present depth displayed to a convenient number (round decimal points to 0) to easily match it with the markings on the line. The color of the line changes every 10m.

\* More accurate adjustment is possible at depths greater than 100m, such as when the display changes from 199m to 200m.

- 2 Enter Line Learning Adjustment using either A or B. There are two methods for making adjustments. The same adjustments can be made using either method.

## A From the Menu Screen

Press and hold the **MENU** button for 3 seconds and the Menu Screen will appear. Press **▼** several times and select **CALIBRATE** and press **SET**.

(See pages 12 for details regarding Menu Screen operation.)

## B Using the buttons

Press and hold both the **O-SET** and **MENU** buttons for 3 seconds to enter Line Learning Adjustment.

You will hear two short beeps.

※ When using this method, after calibration is completed you will return to the Water Depth Display.

(Continued on the next page.)

**Caution:** The values and settings shown on the reel display in this manual are in some cases just examples. Actual values may differ.

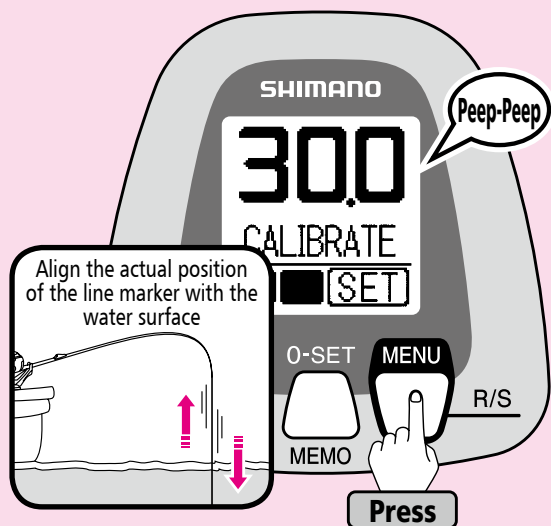

**3** Adjust the display to match the actual position of the line (30m in this example) on the surface of the water.

\* Using the motor (winding in the line or hooking a fish, etc.) will also cancel the adjustment. When that happens, the previous adjustment setting will be used.

Press **MENU** to complete the adjustment. The alarm will sound (peep-peep). The display will return to Standard Mode and the adjusted depth will be shown on the display.

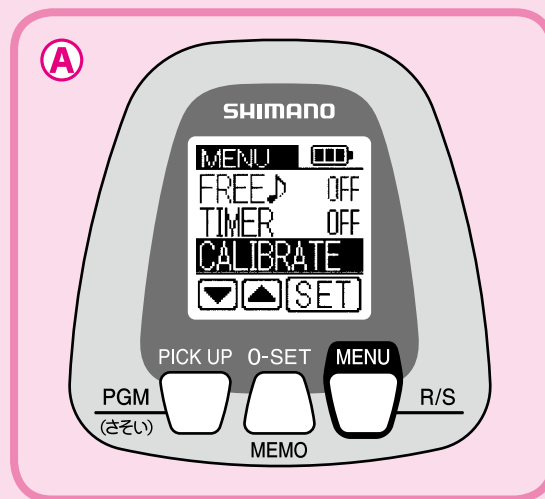

**A** From the Menu Screen

After the calibration is complete you will return to the Menu Screen.

Select **RETURN** on the Menu and you will return to the Water Depth Display and the calibrated water depth will be shown.

Even if the power is turned OFF, Line Learning changes will be saved.

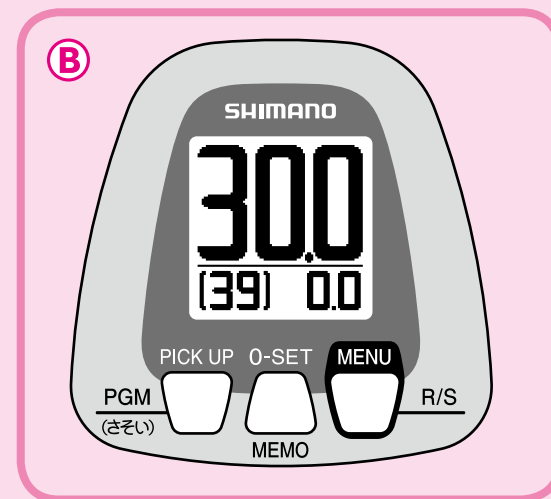

**B** Using the buttons

After the calibration is complete you will return to the Water Depth Display.

The calibrated water depth is shown on the Current Water Depth Display.

**1** The depth on the display is different from the line marking!

100m

sea

**103**  
[ 17 ] 0.0

**2** Use **Line Learning Adjustment**.

What do I do?

Press and hold the MENU button for 3 seconds to go to the Menu Screen

Select **CALIBRATE** from the Menu.

※Or from the Water Depth Display... You can also press and hold both the 0-SET and MENU buttons for 3 seconds to enter Line Learning Adjustment.

MENU

Hold

SELECT

ENTER

**3** The depth shown on the display flashes and does not change even though I am winding in and feeding out the line.

103 CALIBRATE

SET

**4** Just match the markings of the line with the depth shown on the display and ...

then press **MENU**. It will be perfectly adjusted for the next time.

103m

then press **MENU**. It will be perfectly adjusted for the next time.

Press

# Handling Instructions

This reel consists of precision electrical components. Please read and follow the instructions below. Proper maintenance after every fishing trip is recommended to ensure that you will be able to enjoy using the reel for many years to come.

## 1 Caring for Your Reel

\* Remove the power cord and make sure that the reel has completely cooled down before you start any maintenance.

1. Tighten the drag.

2. Wash the outside of the reel with water, using a wet sponge to remove any dirt.

\* Do not immerse the reel in water.

3. Disengage the clutch to let out 2~3m of line while washing between the spool and reel to get rid of the salt as shown in the diagram.

4. Loosen the drag completely and leave the reel to dry in a shady place.

\* Wash or lightly brush the alligator clips using freshwater to get rid of any impurities from seawater.

### \* Salt Build-Up in the Bearings

S A-RBs (Shielded AntiRust Bearings) are made from corrosion-resistant material. However, that does not entirely prevent saltwater from entering the bearings and leaving a build-up of dried salt. They will not rust, but the rumbling sound that accompanies this build-up will sound the same as if they were rusty. The remedy for this will depend on the extent of the build-up, but you can either remove the SA-RBs and rinse them with fresh water to remove the salt, or replace the SA-RBs. It is recommended that you have the SA-RBs maintained regularly.

\* Please detach the power cord from the reel when in storage.

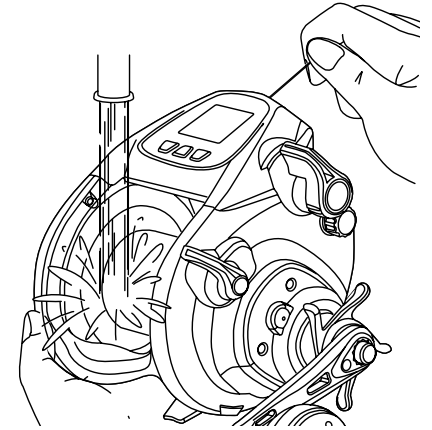

## 2 Cleaning Your Reel

(When you notice a deterioration in spool rotation.)

- If the spool is not rotating as smoothly as usual even after normal maintenance then this may indicate that there is a build-up of salt in the bearing near the handle.

\* Remove the power cord.

1. Carefully immerse the reel in freshwater up to spool as shown in the diagram. Do NOT immerse the whole reel. Rotate the spool to dissolve the salt and regain performance.

Immerse up to this point.

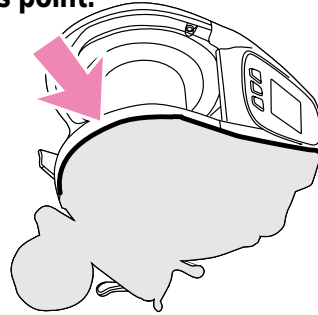

2. Remove the reel from the water and hold it up with the connector side facing down to ensure that the water completely drains from inside the reel.

**If that does not improve the situation, please contact your nearest sales office to have the reel overhauled.**

## 3 Precautions

- One of the characteristics of powered reels is that even though the motor is ON, sometimes line will not get wound in if a fish is hooked because the drag is slipping. This is similar to an automobile going along with the handbrake on. If this goes on for a long time, then the grease in the drag will be burn off and eventually the drag will burn out. Take care not to allow this to happen as it could destroy the entire reel.
- When the line is caught, do NOT exert excessive force on the rod or reel. Instead, please cut the line after taking care to minimize the amount of line left in the fishing ground.
- Please take care when handling the reel. Never throw it in your bag or allow it to bang against other items during transportation.
- NEVER drop or hit the reel. Treat it carefully.
- Take care not to hit the back of the reel or bend the power cord when putting the reel into a rod stand. Take special care not to trap the power cord between the reel and the gunwale.
- Some types of polarizing sunglasses make it difficult to properly view the display.
- After winding in a heavy load, take care when dropping the rig and winding it in the next time as the rig may get tangled with the tip of the rod.
- If the resin footing of the reel is secured to a metal reel mount, this may damage the resin and can ultimately damage the whole reel. Please make sure the resin protector is properly in place when attaching the reel to a metal mount.

## 4 Maintaining Your Reel

- **Regular Maintenance - Please contact your nearest service center.**

The condition of the reel is greatly influenced by not only frequency of use, but also the environment in which it is used, how it is used and the target species. If any abnormality is detected, please contact your nearest service center through the place of purchase immediately. A regular professional maintenance check once every six months is highly recommended.

- Always remove the power cord from the reel before storing it.
- Place the protective cap on connectors when the reel is not in use.
- NEVER try to disassemble the reel as this can damage internal electrical components such as the motor and circuit breaker and may cause the reel to malfunction.
- NEVER oil the drag mechanism as this may decrease performance.
- Leaving the reel in high temperature, high humidity conditions for a long period of time may cause deformation or weakness. Always store in a cool, dry place after carrying out regular maintenance.
- NEVER immerse the entire reel in water, especially the display. (Although the display is shower proof it is best to avoid immersing it in order to prevent any trouble.

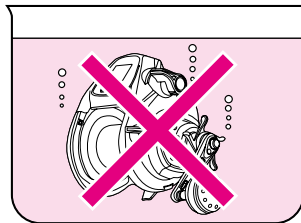

- **Removing the handle.**

1. Undo the two screws to remove the plate from the handle.
2. Undo the bolt inside the handle.

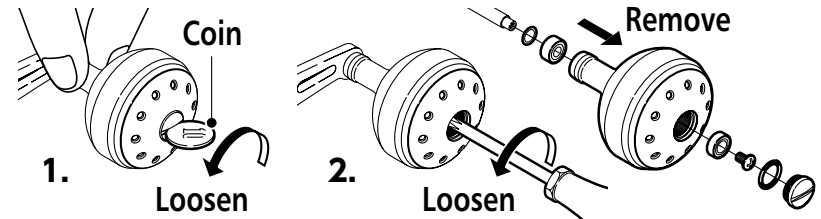

## ● Attaching the rod clamp

Set the reel on the rod, fit the rod clamp onto the rod from underneath and fasten with the clamp nuts.

### ※ 1: Clamp nut washers

If the diameter of rod is narrow, the clamp bolt will stick out from the clamp nut and you will not be able to tighten the nut with the included reel wrench. In this case, use a clamp nut washer.

- ※ 2: When fastening the clamp bolts with 8mm hex nuts, a certain amount of looseness is part of the design. That looseness is necessary during attachment to the rod and is not a defect. The looseness will disappear when the reel is has been firmly attached so there is no need for concern.

### Caution

- When attaching the rod clamp, make sure the rod's reel seat has sufficient strength before attaching.
- Use a standard 8mm hex nut wrench to tighten the 8mm hex nuts.

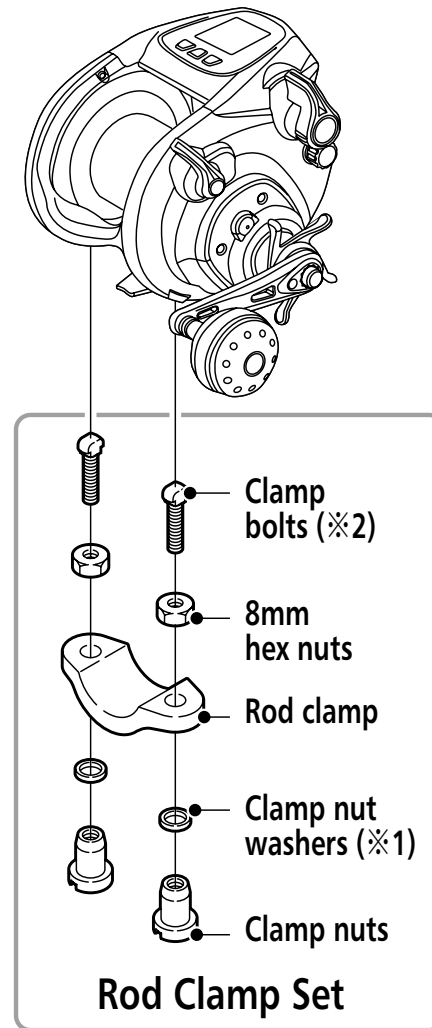

## 5 Safety Features

### ● Automatic Circuit Breaker

The motor will turn ON and OFF at 1 second intervals if there is excessive load on the reel. This is normal. When that happens, the circuit breaker will trip and the display will flash. Leave it flashing for 5 minutes to protect the motor. Learning data will be saved even if the line is wound in or fed by hand. The motor will start to operate again when the flashing stops.

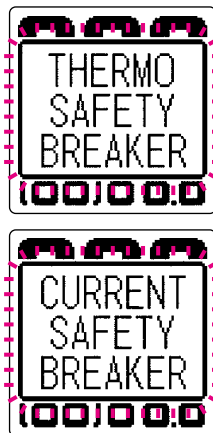

Caution:

- When the breaker has been tripped, it will not be deactivated by turning the power off and on again.
- Depending on the type of breaker action, it will take between 30 seconds and 3 minutes for the breaker to deactivate.

### ● Battery Status Display

When battery voltage drops below 10.5V (13.5V for the lithium-ion battery), or when the power cord is not properly connected, the battery icon on the display will flash. Check the connection first. If there is no problem with the connection then the battery will need to be charged.

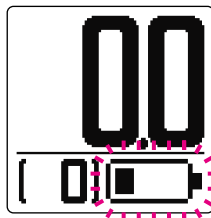

### ● Technical Lever Breakage

Please refer to the **Inquiries | After Sales Service section** to have the unit repaired if this error message is shown in the display.



\* Do NOT wind or unwind the line when this Err error message is displayed. Line Learning will be inaccurate.

### ● If Voltage is Too High

This error message will be displayed if a voltage of more than DC28V is applied. Please check the power source and make sure that it provides between 12V~24V.

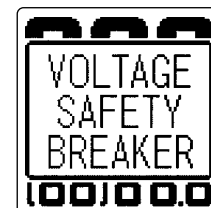

### ● Inaccurate Line Learning Operation

This error message indicates inaccurate Line Learning. Carry out Line Learning again.

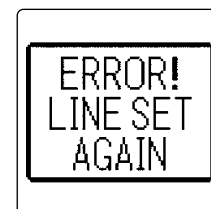



# Specifications

## Maximum Winding Strength

**78kg**  
764N

Reference

## Maximum Drag

**25kg/57lb**  
255N

Maximum drag for Shimano boat reels is the drag produced when a person pulls the reel with one hand.

## Maximum Winding Speed

**140**m/min.

Retrieval speed when winding the line in with no load.

## Actual Winding Speed

1kg (Load)    2kg (Load)    3kg (Load)  
**120**m/min.    **116**m/min.    **111**m/min.

The time required for bringing a rig to the surface from 100m. Actual winding speed is for example, is the speed at which a specific load can be reeled in from 100m at maximum speed using a #9000 series reel with 940m of POWER PRO 100lb.

Measuring Conditions: A 13V power supply at 15~20°C. (Speed will be higher if a higher voltage lithium battery is used.)

\* Measurements may fluctuate according to the environment in which the reel is used.

## Actual Maintainable Winding Strength

**14kg**  
137N

The winding strength that can be maintained for an extended period of time.

The actual maintainable winding strength is the weight of the load when the circuit breaker actually trips under the gradually increasing load.

Model Number	Product Code	Gear Ratio	Weight (g/oz)	PowerPro EU DIA. (mm-m)	PowerPro US (lb.-yds.)	Winding Capacity (cm/turn : inch/turn)	Spool Dimensions (diameter/width (mm))	Handle Length (mm)	Bearing Number (balls/roller)
Force Master 9000	51RG459100X	3.1	1530/54	0.32-1870 0.36-1650 0.41-1150 0.43-940	40-2050 50-1800 65-1260 80-1030	88 : 35	90 / 60	75	3 / 0

### ● Standard Accessories

Power Cord, Operating Manual, Component Diagram, Line Threading Pin, Reel Wrench, 10m line, Rod Cramp, Reel Bag

### ● Power Supply (DC Only)

DC12V (Compatible with lithium batteries.)

### ● Caution

When using POWER PRO 50lb or less, take care not to cause backlash or the line may be caught between the spool and the frame.

# Troubleshooting

Situation	What to do	Reference
The display is black or shows all characters.	This happens when the unit is left somewhere at high temperature, such as in a car boot. It will return to normal when the temperature goes down.	
Nothing appears on the display.	Check to see if the (+) and (-) of the power cord are connected properly to the battery. Check to see if the battery has sufficient charge. Check the surface of the alligator clips for foreign objects.	P.16
Nothing appears on the display (when used in extreme cold).	When the LCD display is left in extreme cold (below -15°C), the display will not work for a while even though the power is turned on. Wait until the circuit board inside the unit warms up. When fishing in extremely cold conditions, it is recommended that the reel be kept in the cabin or under cover until it is needed.	
Line Learning cannot be set.	Please try the Line Learning process again.	P.17~32
The numbers on the display do not change even when line is fed out.	Please try the Line Learning process again.	P.17~32
There is too much discrepancy.	Please try the Line Learning process again.	P.17~32
The number on the display does not match the line depth marks.	Depending on the type of line, sometimes the line gets stretched, which can cause discrepancies on the display.	
The Gunwale Stop position is wrong.	This is probably due to winding tension or stretched line. Carry out 0 set. Gunwale set is only possible between 1~6m. Settings between 0~1m are rounded up to 1m for safety reasons.	P.37~P.38 P.46
The display is working but the motor is not.	Check if the battery has enough charge. When the battery does not have enough charge, the motor may work at low speed but not at high speed. Charge the battery and test the reel. If that does not improve the situation, you may need a new battery. The motor may not work when the temperature of the reel is below 0°C. When fishing in extremely cold conditions, keep the reel in the cabin or leave it ON until it is needed. Furthermore, the motor does not start when the display shows less than 1m for safety reasons.	P.16 P.15

Situation	What to do	Reference
<b>The motor stops while winding.</b>	Make sure all the screws on the power cord connector are at the connector. If the boat's power supply terminal or the reel's power cord connector is rusty, the current will not flow properly. Remove any rust and try again. Battery charge should also be checked.	P.16
<b>There is a strange sound in the reel even when not winding.</b>	A condenser is installed under the display unit to protect the reel from fluctuating current. The condenser may vibrate and make some noise when the reel is used with an unstable power supply. However, this will not affect reel function so it is OK to keep on using it.	
<b>The characters "Er" appear in the display.</b>	This is an error message generated by a safety feature. Refer to the "Safety Features" page.	P.68
<b>Alphanumeric characters are displayed for two seconds when the power is turned on.</b>	This is a display used for identification, and is not the sign of a problem. The display details vary depending on the product model.	

In order to enjoy fishing, please turn the power on and check the performance of the reel before you go.

(The motor does not come on unless the line is fed more than 1.1m.)

If above checks still do not improve the situation, please contact the retailer you purchased the reel from and explain the problem in detail.

# Product Inquiries / After Sales Service Information

Please include your telephone number when you send us an inquiry by mail.  
It is easier to explain some reel mechanisms on the phone rather than in writing.

- When the reel needs repairing, please take it to the retailer you purchased it from together with the guarantee and the power cord. We need to know detail regarding the problem. (E.g. The stopper does not work.)

A charge will be made for the necessary replacement parts and labor. We cannot compensate for damaged or lost tackle arising from a damaged Shimano product and/or fishing trip expenses.

- If you wish to order a part or replacement spool, please order from the place of purchase, specifying product name, merchandise code/product code, part name/number as shown in the component diagram. (We recommend sending in the whole reel for the repair.)

Example/

Product Name: Beast Master 9000

Product Code: 5RG469000

Part Number: 2

Part Name: Handle

- Shimano retains fundamental parts (i.e. the parts necessary to maintain the function of the product) for fishing rod for up to 6 years after the manufacturing of a particular model is stopped. We may not accept a request for the repair if parts are not available. Some other minor parts may not be provided even if it is less than 6 years since the manufacturing of the product has been stopped.

## ● Product Code

The top five digits of the product code is recorded on the instruction manual, component diagram, and bottom or side of the package.

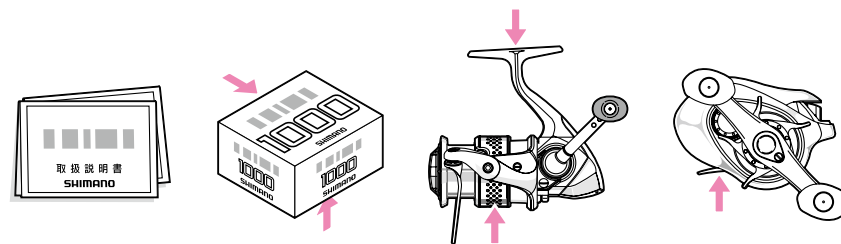

## SHIMANO

### SHIMANO AMERICAN CORPORATION

One Holland, Irvine, CA 92618 U.S.A. Phone: +1-877-577-0600

### SHIMANO EUROPE FISHING HOLDING B.V.

Industrieweg 24, 8071 CT Nunspeet, The Netherlands Phone: +31-341-272233

### SHIMANO GERMANY FISHING GMBH

Diessemer Bruch 114 F, 47805 Krefeld, Germany Phone: +49-2151-55670

### SHIMANO ITALY FISHING S.R.L.

Via Privata Maestri del Lavoro 29, 20025 Legnano Milano, Italy Phone: +39-0331-742711

### SHIMANO CANADA LTD.

427 Pido Road Peterborough, ON K9J 6X7, Canada Phone: +1-705-745-3232

### SHIMANO AUSTRALIA FISHING PTY. LTD

2 Wurrook Circuit, Caringbah, NSW 2229, Australia Phone : +612-9533-0000

### SHIMANO (SINGAPORE) PTE. LTD.

20 Benoi Sector, Jurong Town, Singapore 629852 Phone: +65-6265-4777

### SHIMANO NEW ZEALAND

79 Apollo Drive, Albany, Auckland City 0632, New Zealand Phone : +64-9-478-1969

### SHIMANO INC.

3-77 Oimatsu-cho, Sakai-ku, Sakai City, Osaka 590-8577, Japan Phone: +81-72-223-3467

[www.shimano.com](http://www.shimano.com)

### SHIMANO SATELLITE SERVICE CENTERS

#### North America

To receive the location of the nearest authorized warranty center to you please visit us on the internet at <http://www.shimano.com>, or call (877) 577-0600 8-5 PST to speak directly to a service representative.



14

PRINTED IN JAPAN  
IMPRIME AU JAPON





# SHIMANO