

Preface:

In order to prevent injuries and fires, pls pay attention to the following instructions:

In order to prevent short circuit and so on, do not drop the metal objects in the device.

If there is smoke or peculiar smell the device, pls turn off the power at once.

Pls do not make the device falling or strong collision. In order to prevent device failure, pls observe the following note:

Pls do not install the device in the place of strong sunlight, high temperature, high humidity or dusty.

Pls replace the fuse which is the same specification. If you are using different specification of the fuse, may cause failure of the device.

In order to prevent short circuit, pls pull out the power wire when you replace the fuse.

In order to be able at any time to deal with road and traffic conditions change, pls lower the volume when driving.

Pls do not get the device wet when washing car, this may cause short circuit, then fire or other failure will be caused.

Precautions

1. If any abnormal behavior of the unit is found, pls use spiky object to press RESET key to resume factory default.

2. If you have parked the car in hot or cold weather for a long time, pls wait until the temperature in the car becomes normal before operating the unit.

3. No fierce impact to the unit for preventing damage to any mechanisms inside.

4. The unit consists of high precision parts, pls do not open the lid or adjust any components without authorization. Any maintenance needed, pls go to professional after-sale service center for services.

5. Operate the unit correctly according to this manual to prevent unnecessary problem. The guarantee won't be valid if the problem is caused by inappropriate operation.

1. if connect 24V will burn the unit

Remark: Only marked the 24V can be used on the 24V unit

Warning

1. Only connect the unit to a DC 12V power supply with negative grounding. if connect 24V will burb the unit.

Remark: Only marked the 24V can be used on the 24V unit.

2. Never install the unit where the operation for safety driving is restrained.

3. Never use the video display function in the front when driving to prevent the violation of laws regulation and also to reduce the risk of traffic accident except using for rear view video camera.

4. Never expose the unit, amplifier, speakers to moisture or water to prevent electronic sparks or fires.

5. Pls don't change the fuse in the power cord without professional guidance;

improper fuse may cause damage to this using unit or even cause fire.

Installation

The unit installs for security, pls install it refer to the following diagram description:

1. pls make the unit in proper place, connect the unit refer to the diagram, and test it works well or not.
2. Pls wrapped the connection line with insulation tape to ensure complete wiring after testing well.
3. Pls bend the hook of metal 1, and insert the metal to instrument panel then fixed it.
4. Put the unit into metal hook until it lock.

Remove

Note:

1. Pls ensure install the unit in the position that doesn't interfere with the normal operations of driver, and no harm for emergency braking.
2. For exactly install, pls use the accessories provided by the unit only, otherwise it will cause unnecessary damages. If more holes or other changes in facing or structures are needed, pls contact with dealer nearby.
3. Installed after the first power test please press the reset button, then press the clock button to set the clock, the unit can be used normally.

Dismantling:

The unit without key, you can pull out by your hand.



General Features

Support RMVB/RM/FLV/3GP/MPEG/DVIX/XVID/DTA/VOB/AVI video file format

Support MP3/WMA/WMV/OGG/APE/ACC/FLAC audio file format

Support JPEG/BMP/GIF/TIF image format scan

Adopt 800*480 resolution 26 million Full Color TFT Display Screen

2way video output (one way video output, one way rearview video output).

1 way audio output

High Definition FM audio function and 18 stations preset

AM audio Function and 12 stations preset (Optional)

Support High Capacity TF card

Display song words and names

Support file navigation

Firmware update

Support Rear View Function(Optional)

Colorful Backlight(Optional)

1 Way audio input(Optional)

support the large capacity SD card, USB device

support bluetooth and touch function (optional)

Auto-memory store function after power-off.

Basic operation

1. when use reversing rear view function, reversing video signal from the corresponding port input connection back line, when reversing will automatically switch to reversing visual state.
2. Audio/Vedio input(optional)
Connect audio/Vedio lines, press Mode can select AUX-2 Reversing Video Signal input state.

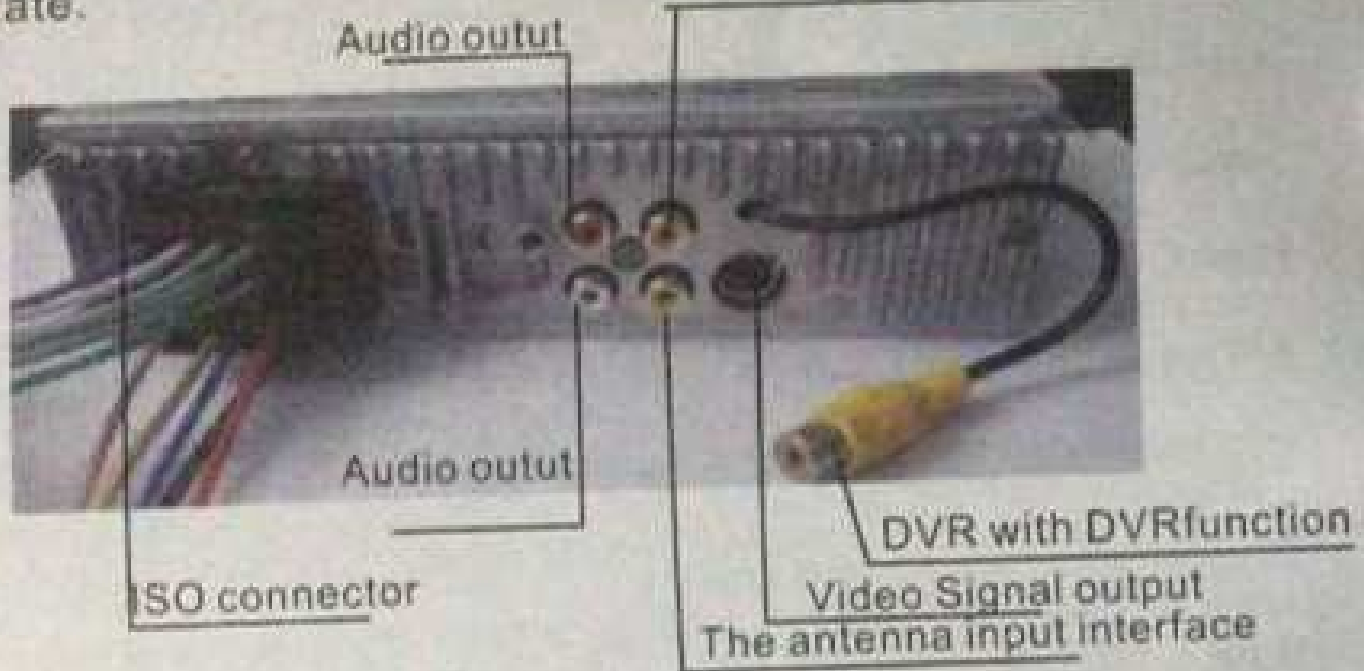

3. bluetooth function only for the unit with bluetooth

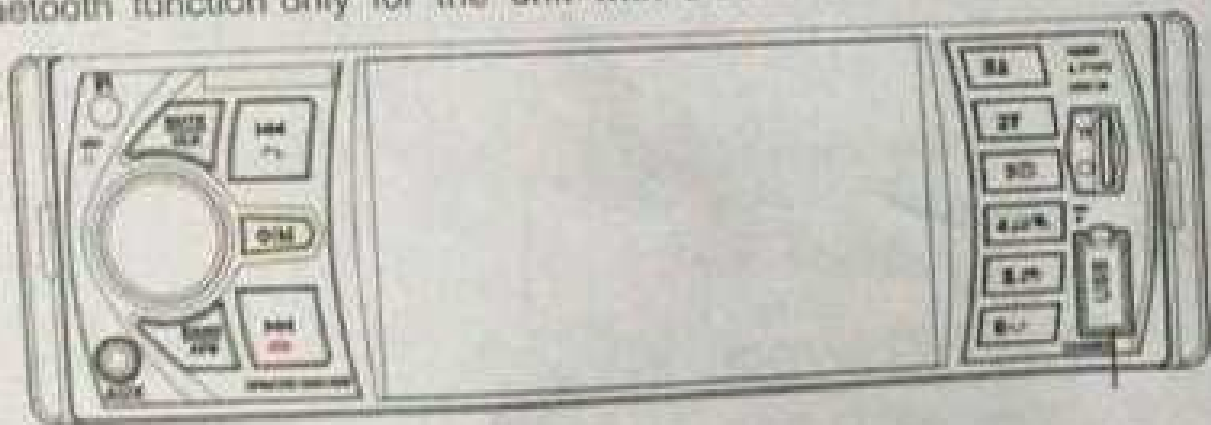

After connecting the mobile, the bluetooth symbol turn green means the connection is

ok, when calls come in will enter into the bluetooth interface automatically, press

answering the phone, press " " hanging up the phone.

Use the BT functin, please Use the phone pairing, equipment number GBT-CARKIT, for password:0000

Wire Diagram

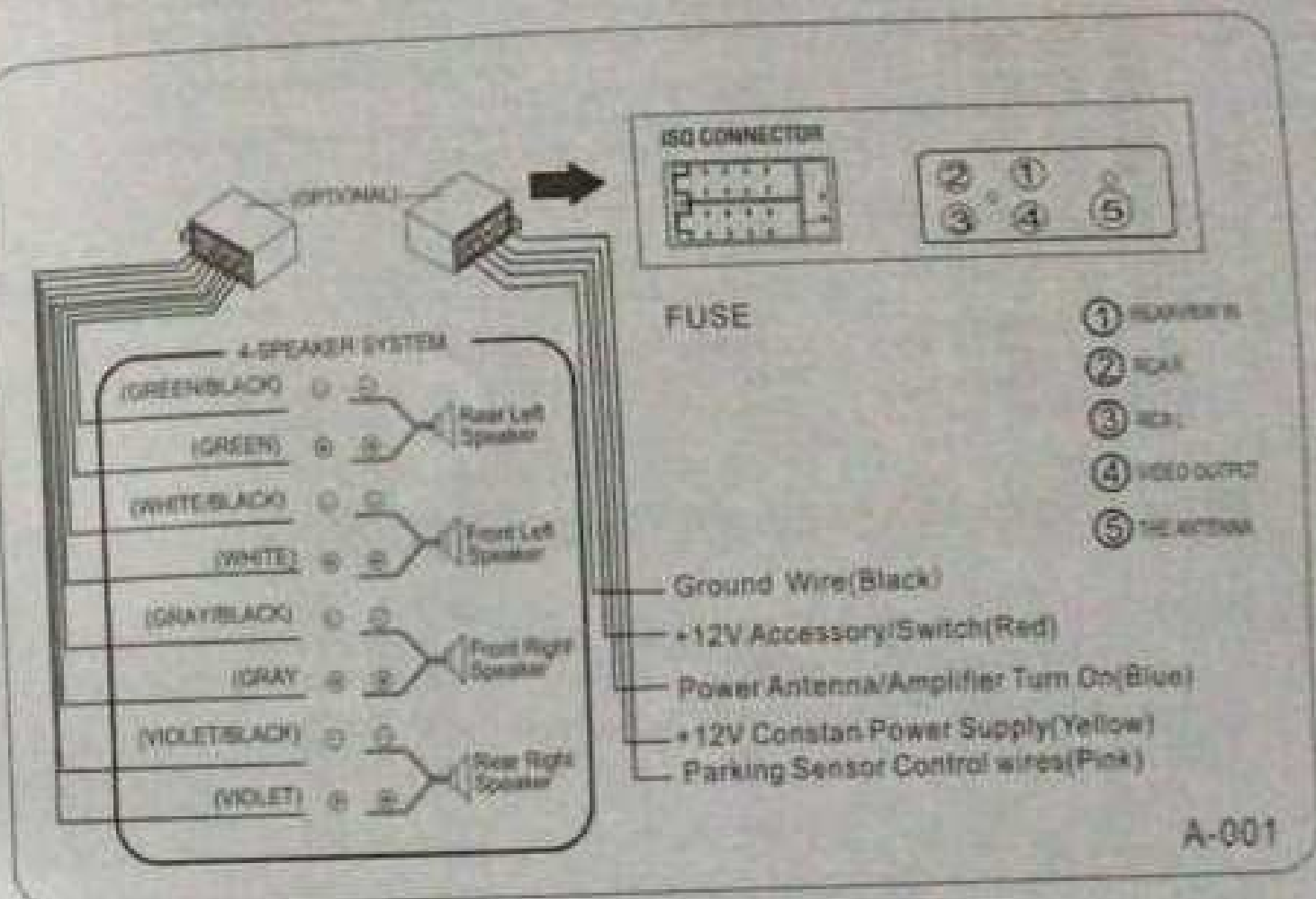

⚠ Pls check the speaker line carefully before installation. If any grounding or touching, pls connection again or the unit will be burned.

Specification

SNR	65dB
Frequency response	20Hz-20KHz
Loudspeaker impedance	4Ω_8Ω
The maximum output power	4*45W
Tone Control	Bass +/-7dB(100Hz) Treble +/-7dB(100Hz)
FM	
FM frequency	87.5MHz~108MHz
Sensitivity	25dB
Selectivity	60dB
Separation	35dB
AM	522KHZ~1620KHZ

Remote Control Description



- 1 **MOVIE** switch to video menu or video playback station
- 2 **MUSIC** switch to audio menu or audio playback station
- 3 **Numeric buttons** select channel by short press
save channel by long press
- 4 **VOL-** turn down volume
- 5 **SEL** select BASS/TRE, and front/rear L/R balance
- 6 **OK** Confirm/Pause Play function
- 7 **←** Switch to previous or left and up select
- 8 **VOL+** Turn up volume
- 9 **MUTE** mute function
- 10 **⏸** Play/pause during video and audio file
- 11 **INT** scan song during music playback, and switch to next song after 10s
- 12 **BAND** enter into FM, and switch among FM1, FM2 and FM3
- 13 **EXIT** exit/return back to previous class menu
- 14 **→** switch to next or right and down select
- 15 **EQ** open EQ menu, select different EQ station
- 16 **RPT** select different repeat modes

Front panel Function Description

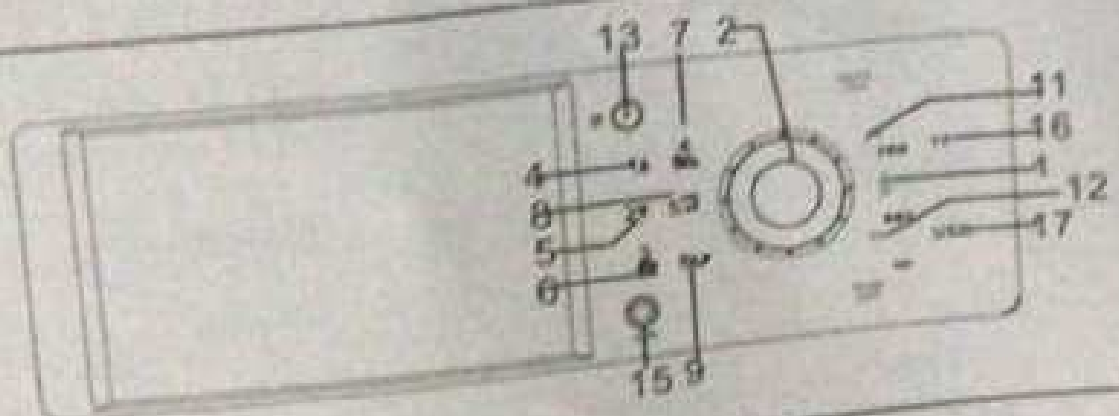
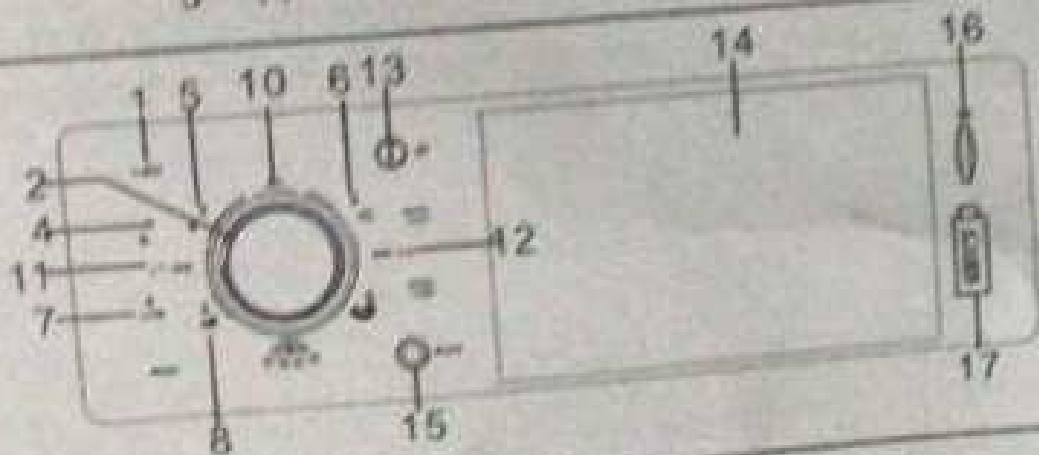
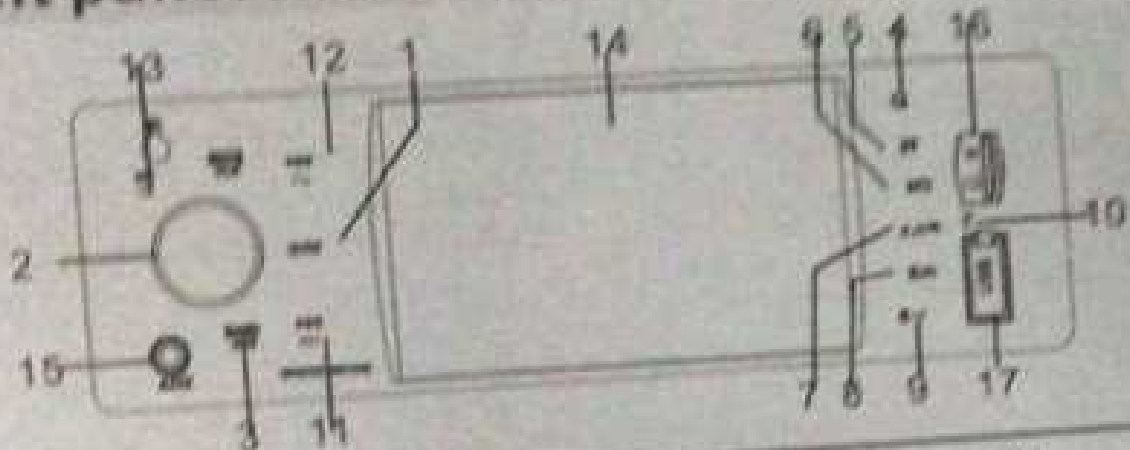

Front panel Function Description

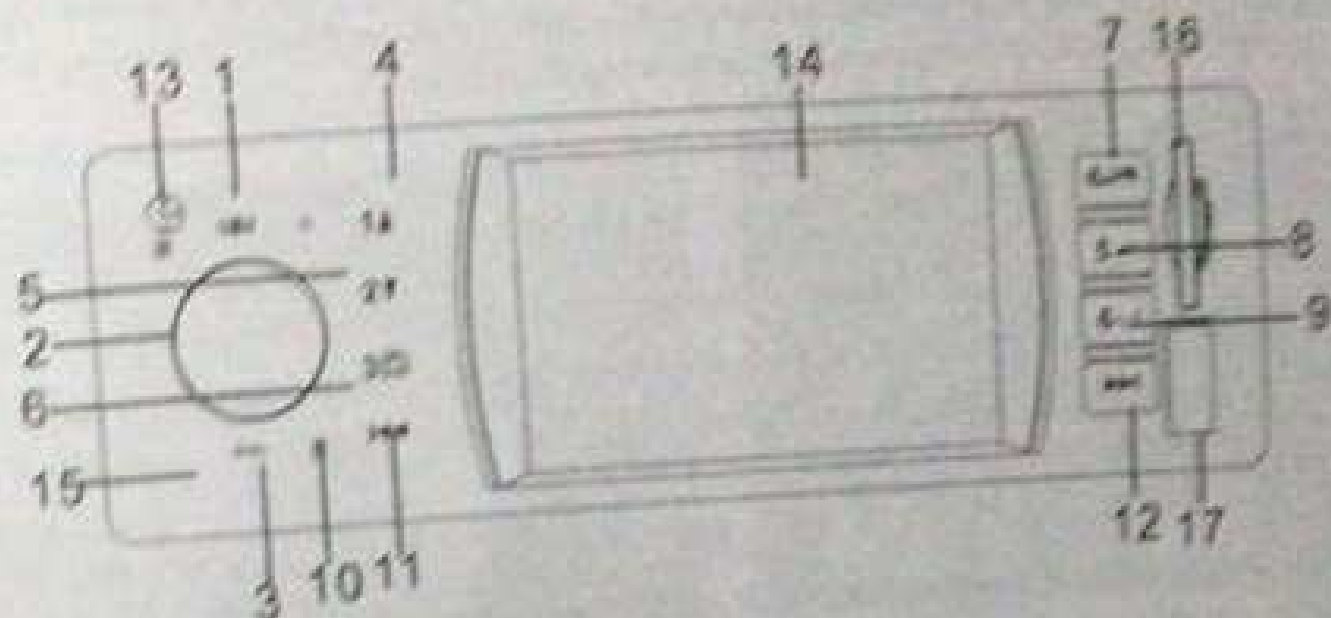

1. **MODE**: turn on by long or short press during standby, switch among FM/USB/SD/AUX-IN by short press, and standby by long press during working.
2. **SEL**: Short press for switch among VOL/BAS/TRE/BAL/FAD. Adjust the parameters by rotate the knob.
VOL: 00-39
BAS: 7-00-7 TRE: 7-00-07 BAL: RT-00-LT FAD: RT-00-F7
3. **BAND**: Enter into FM during USB, SD and AUX, switch among FM1/FM2/FM3 by short press, and automatic searching and save channel by long press during FM.
4. **⬆**: Upward function during audio and video playback; 1 function by short press, and saving channels by long press during FM.
5. **⬇**: Downward function during audio and video playback; 2 function by short press, and saving channels by long press during FM.
6. **⏮**: Switch to video output of external video, and press again to display during video playback; 3 function by short press, and saving channels by long press during FM.
7. **⏪**: Switch between video and audio playback; 4 function by short press, and saving channels by long press during FM.
8. **⏸**: Play/Pause during video playback, and confirm during menu; 5 function by short press, and saving channels by long press during FM.
9. **⏩**: Back to menu during video, audio and AUX-IN; 6 function by short press, and saving channels by long press during FM.
10. **RESET**: restart the unit.
11. **⏮**: Short press: Previous during video and audio playback, left and upward during menu; Semi-automatic searching by short press, and fast backward by long press during FM, or frequency tuning by long-short press.

Front Panel Function Description

- 12 **FF**: short press: next during video and audio playback, right and downward during menu; Semi-automatic searching by short press, and fast forward by long press during FM, or frequency tuning by long-short press.
13. Remote Control Receive Window.
14. Display Window. 15. AUX-IN port. 16. SD Card slot 17. USB port
- 18 **MUTE/CLK**: short press: mute/cancel mute Long press: set clock and time long press MUTE enter CLK state, will Display CLK state short press MUTE/CLK again -- hour--minute-- Second -- year-- month-- date -- by rotating the SEL knob to regulate.
19. EQ: open the EQ menu up down song key is used for selecting different EQ.
- 20 **MOVIE**: switch to video menu directly or video state.
- 21 **MUSIC**: switch to audio menu directly or audio state.
- 22 **LOUD**: loudness switch 23 **CLK**: date/clock display and regulating function.

Basic Menu

FM 3.6"



Main Menu 3.6"



Setting 4.1"



Audio interfact 4.1"

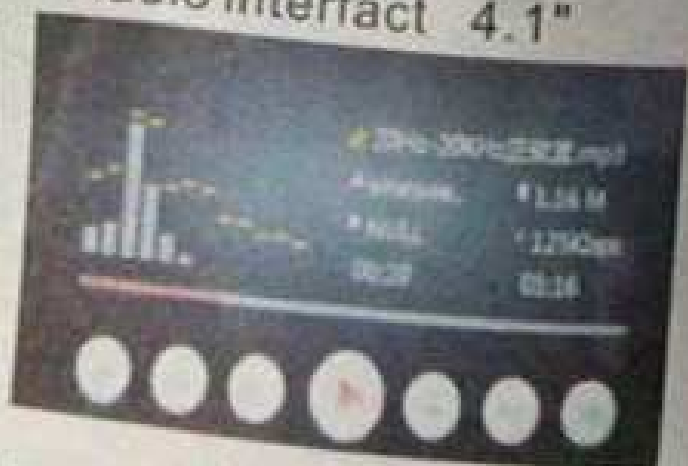

Basic Menu

Setting



Audio interfact



Main Menu



FM interfact



FM with DVRfunction



Music with DVRfunction

