

Art.-Nr. 95605/75605

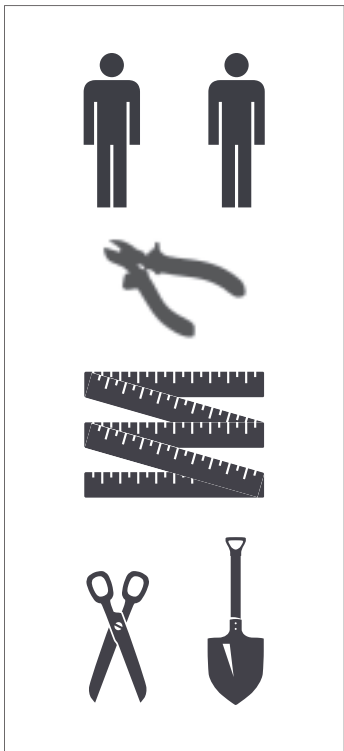

<p>A</p>	<p>B</p>	<p>54+2 x L (7,8 cm)</p>	<p>2 x P (30,5 cm) 4 x Q (40,5 cm) 2 x R (50,5 cm) 4 x S (60,5 cm)</p>
<p>C</p>	<p>D</p>	<p>3 x M (20,6 cm)</p>	
<p>E</p>	<p>F</p>	<p>1 x N (25,6 cm)</p>	
<p>G</p>	<p>H</p>	<p>1 x O (32,6 cm)</p>	
<p>2 x G (8,5x 60,2 cm)</p>	<p>I</p> <p>2 x H (8,5x 40,2 cm) 1 x I (8,5x 20,2 cm)</p>	<p>2 x K (∅ 35 cm)</p>	<p>12 x J</p>
		<p>1 x Y (68 x 460 cm)</p>	

1

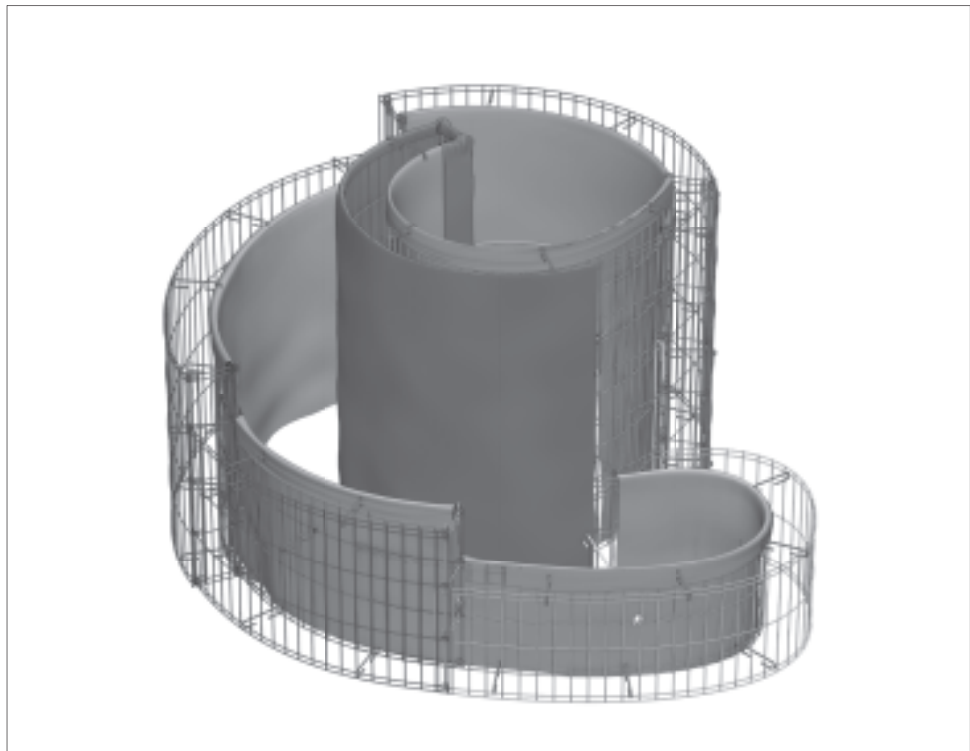
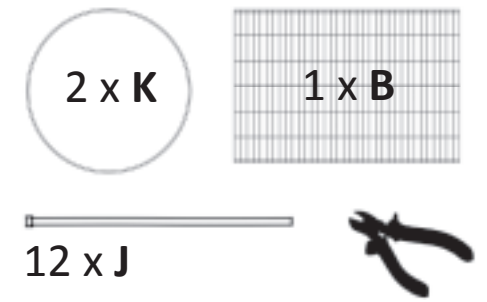
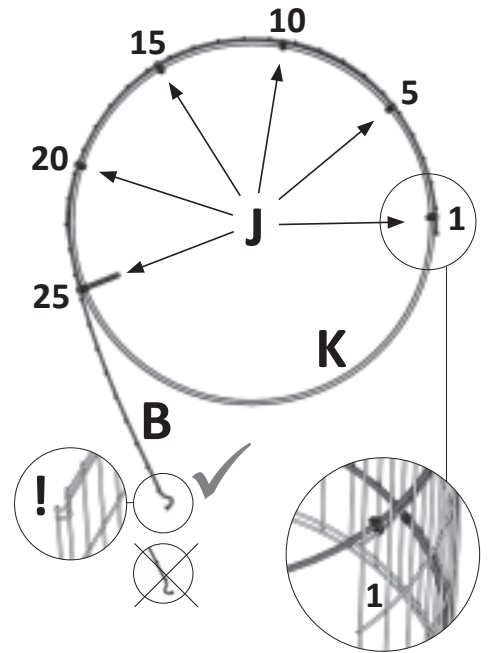
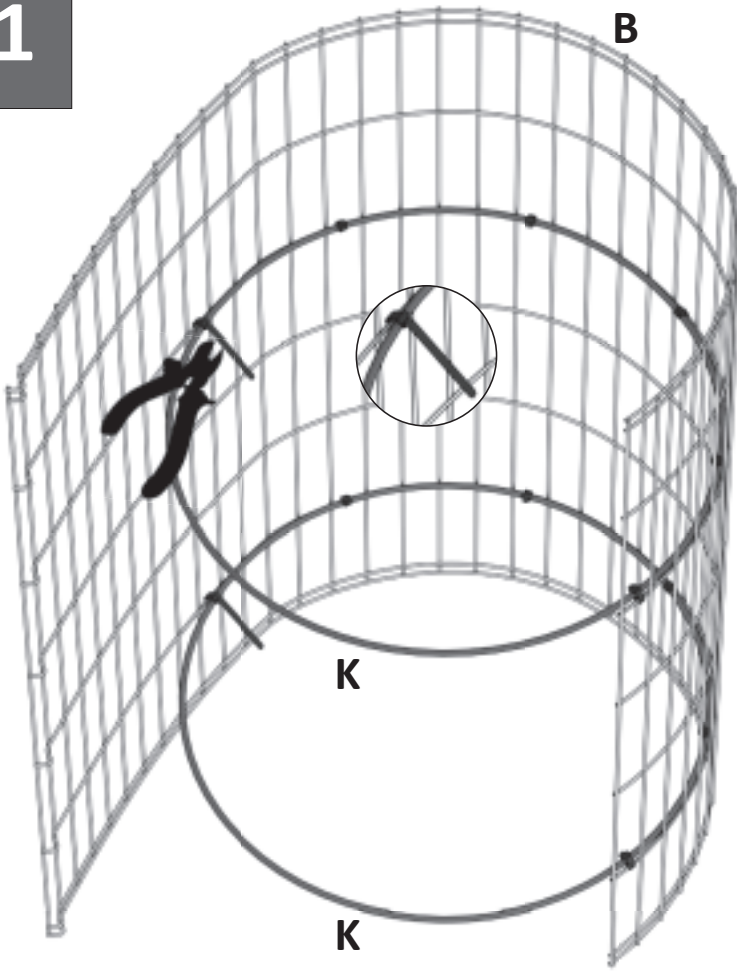

2

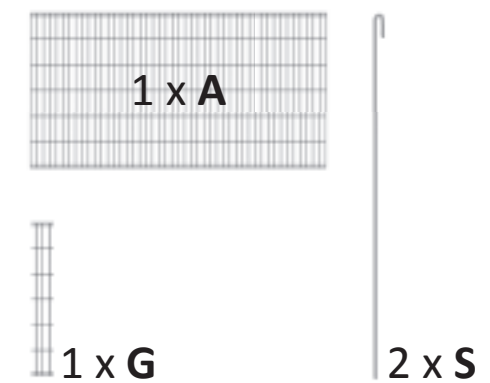
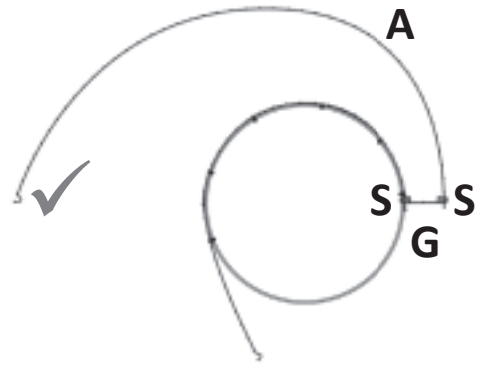
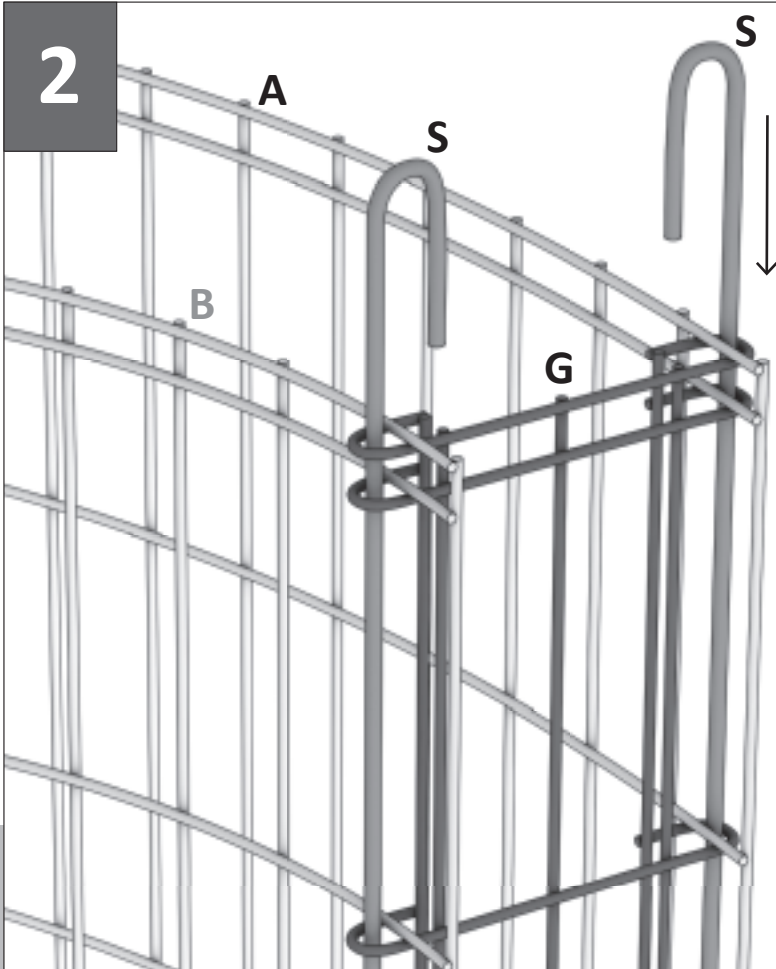

3

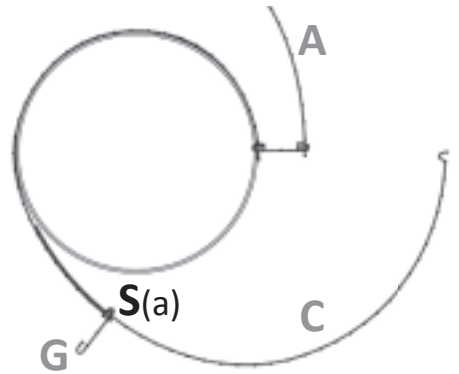
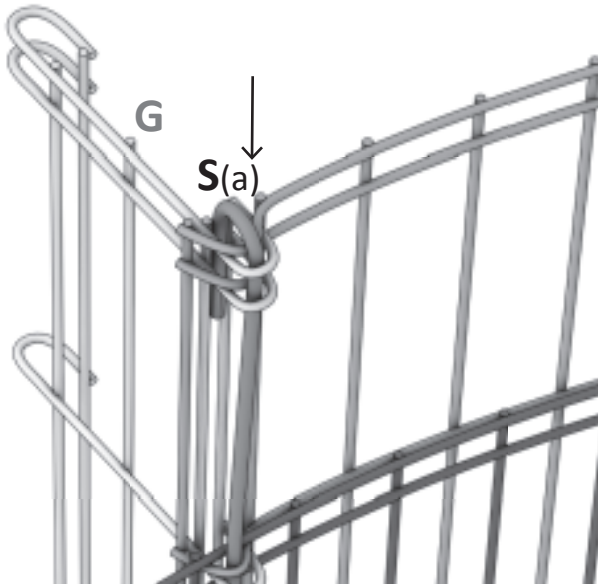
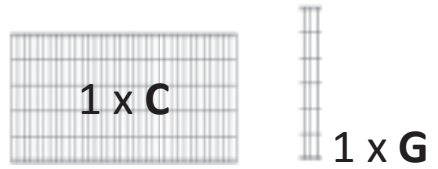
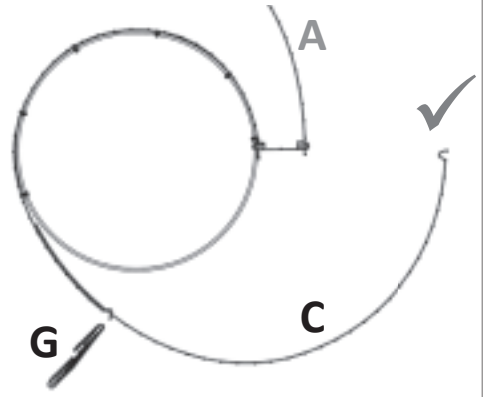
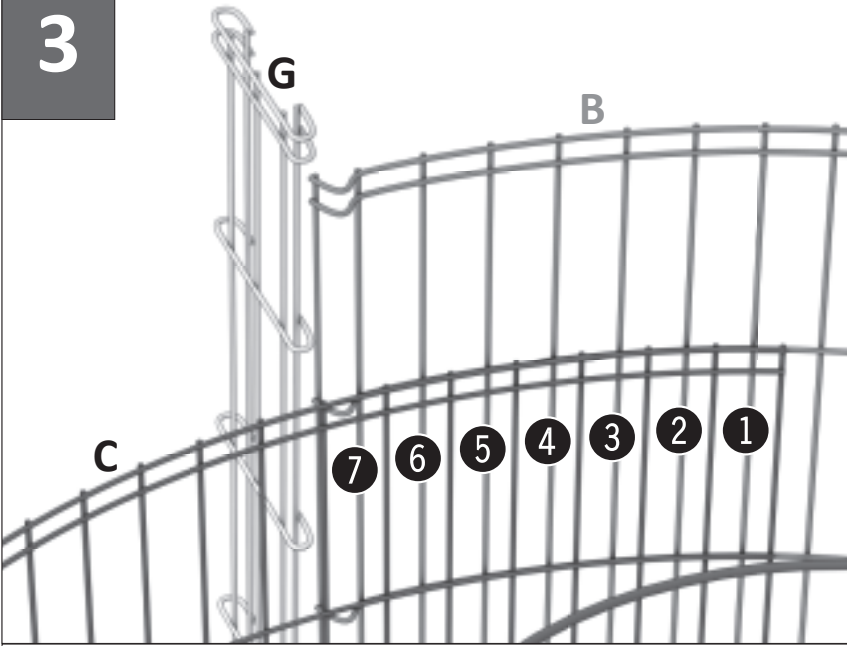

4

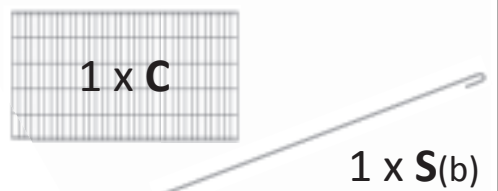
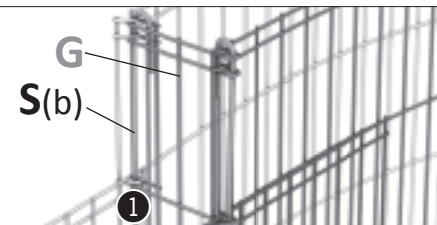
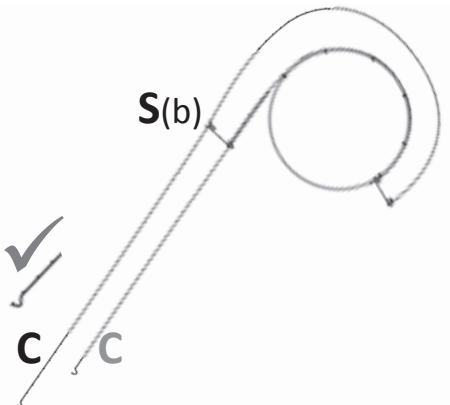
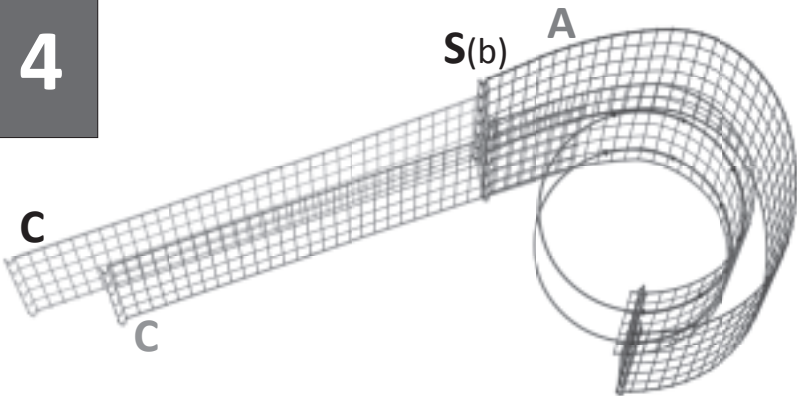

5

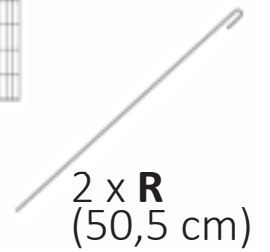
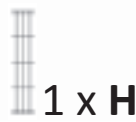
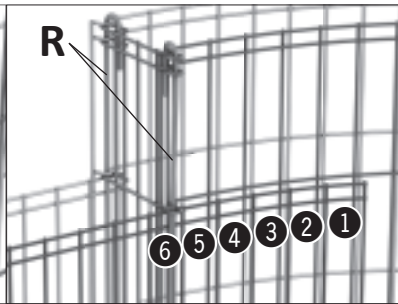
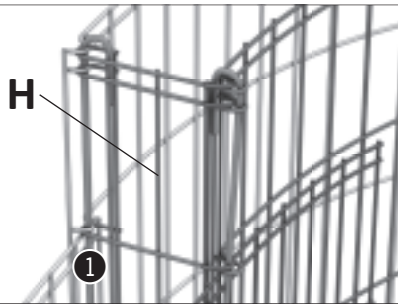
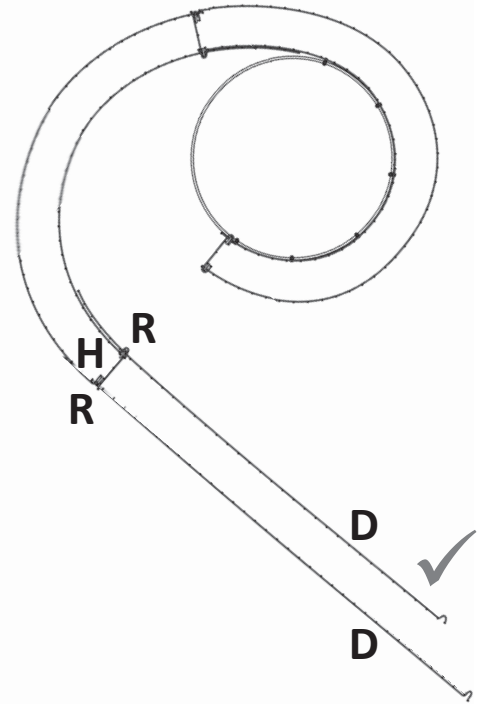
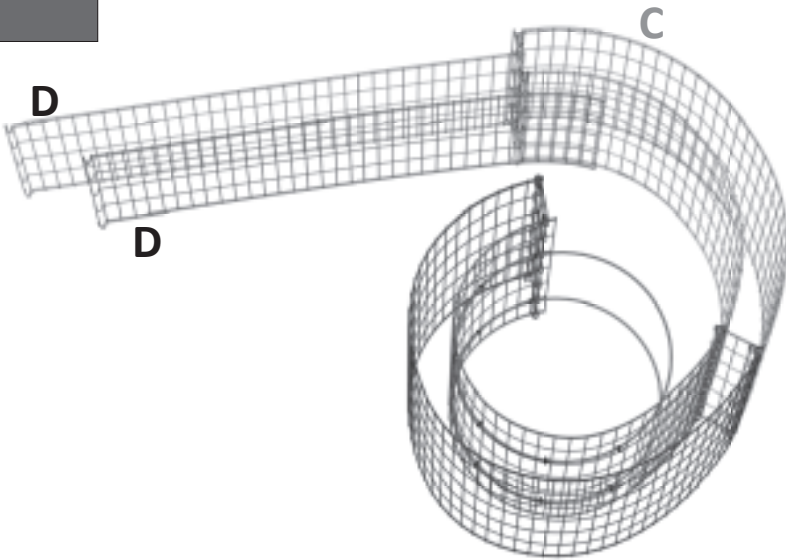

6

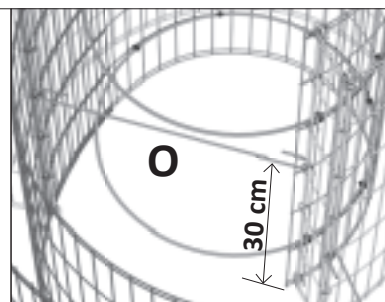
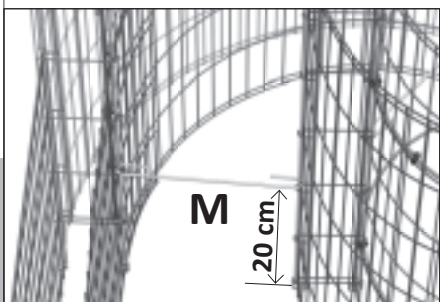
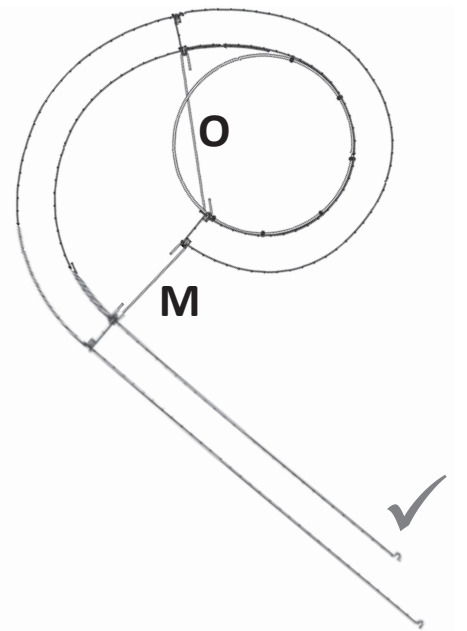
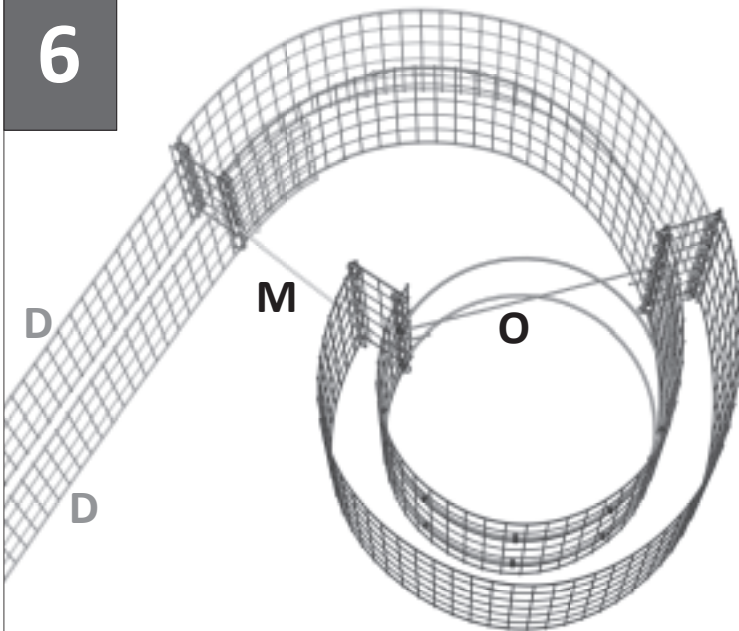

1 x M (20,6 cm)

1 x O (32,6 cm)



7

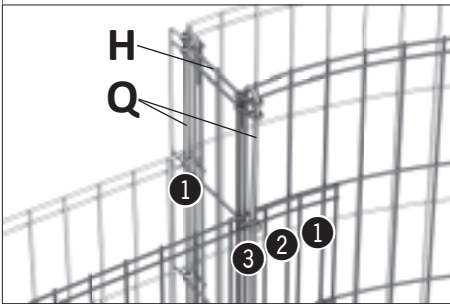
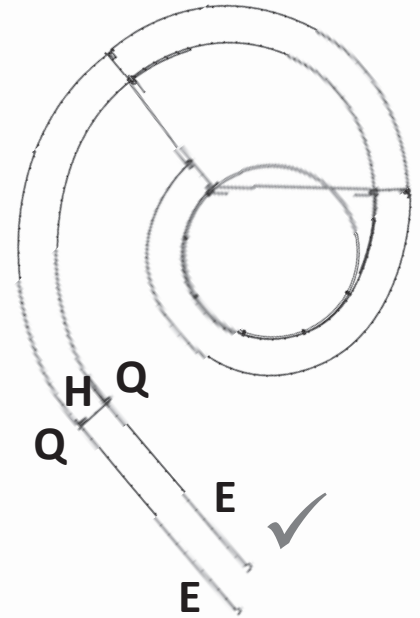
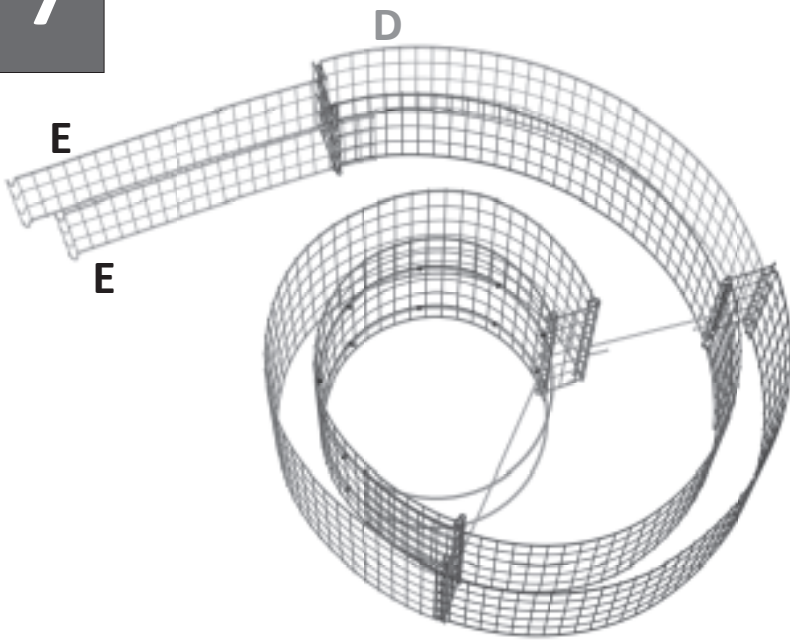

2 x E

1 x H

2 x Q (40,5 cm)

8

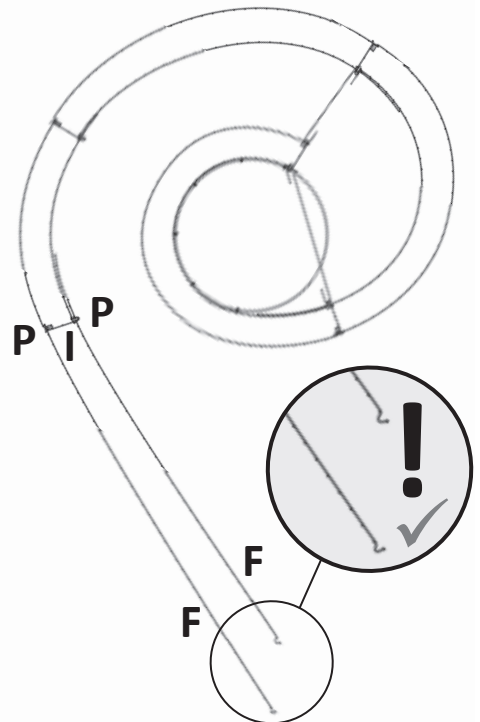
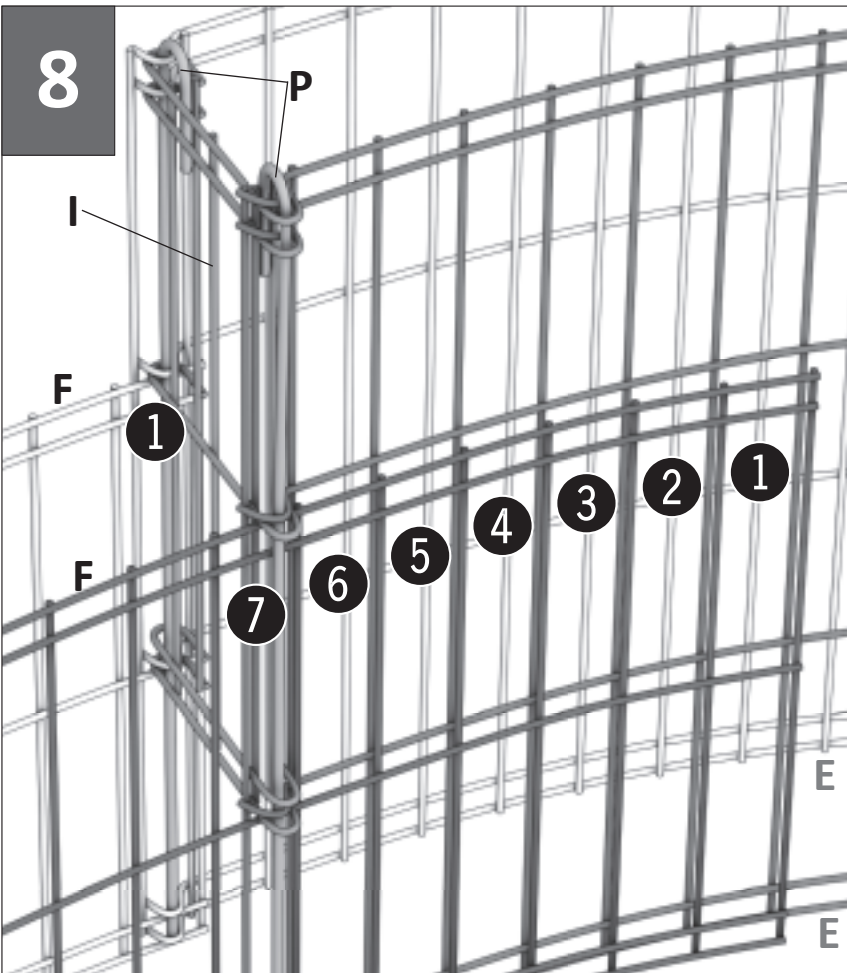

2 x F

1 x I

2 x P (30,5 cm)

9

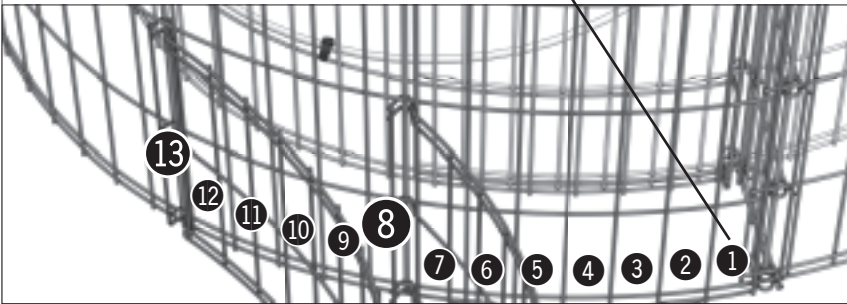
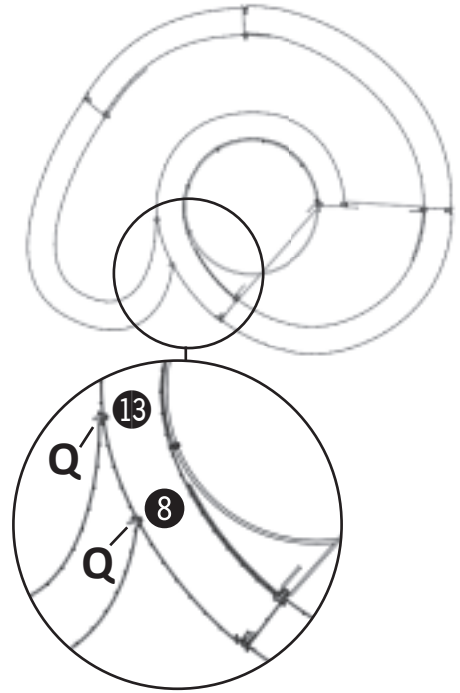
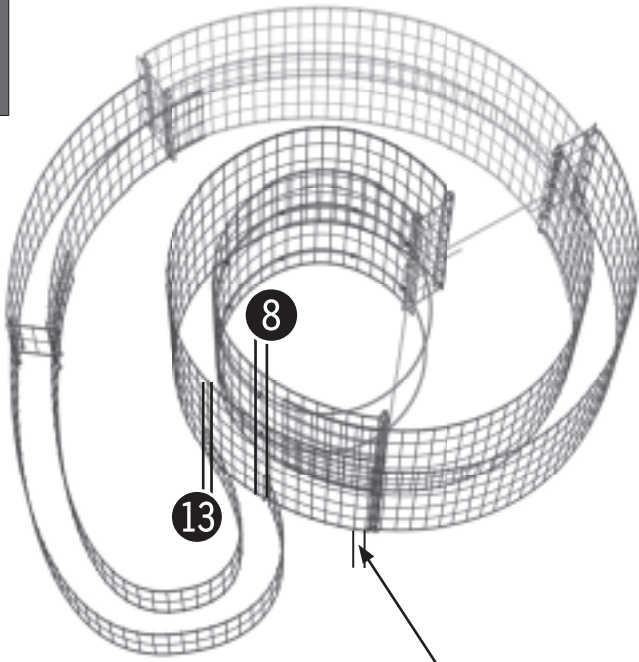

2 x **Q** (40,5 cm)

10

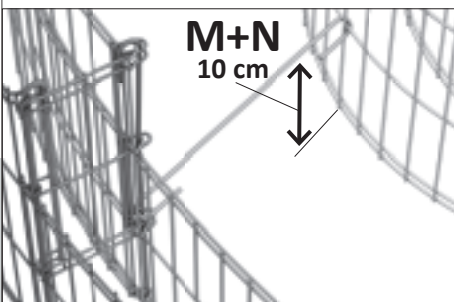
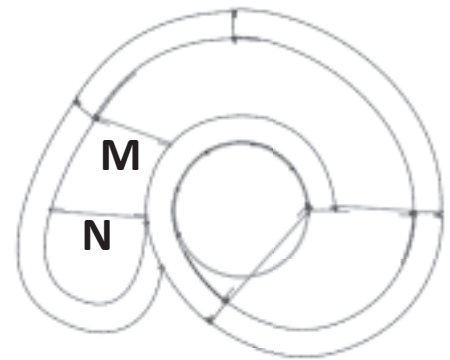
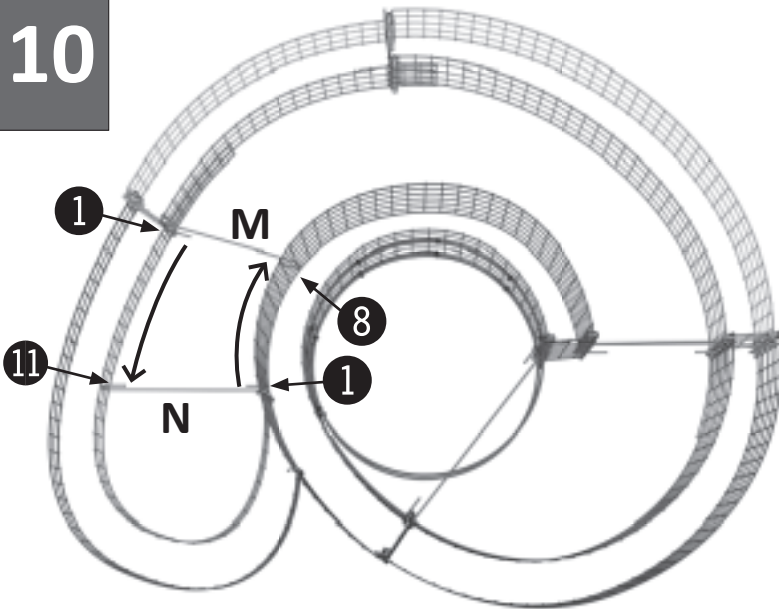

1 x **M** (20,6 cm)

1 x **N** (25,6 cm)



11

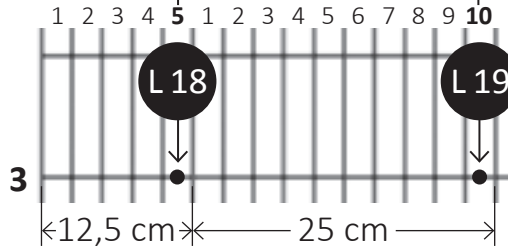
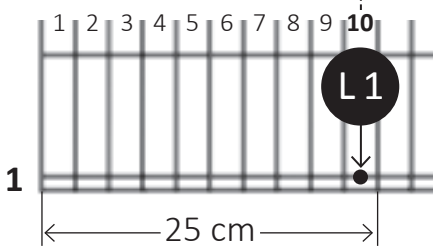
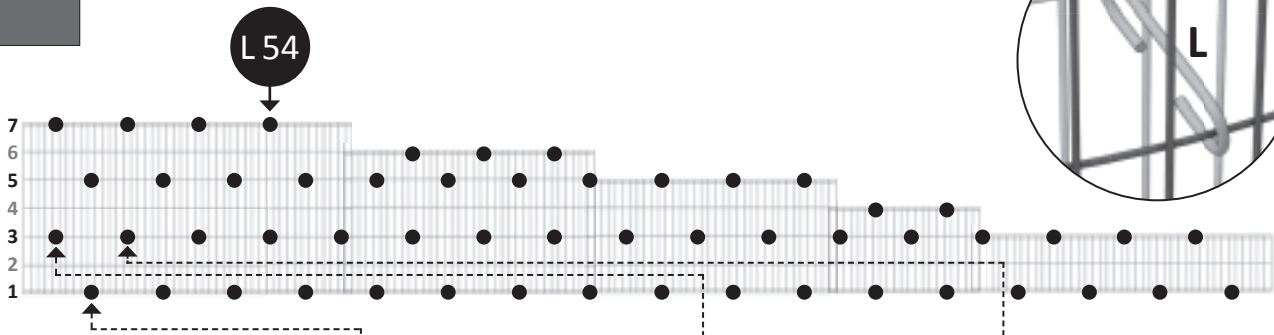

54 x L

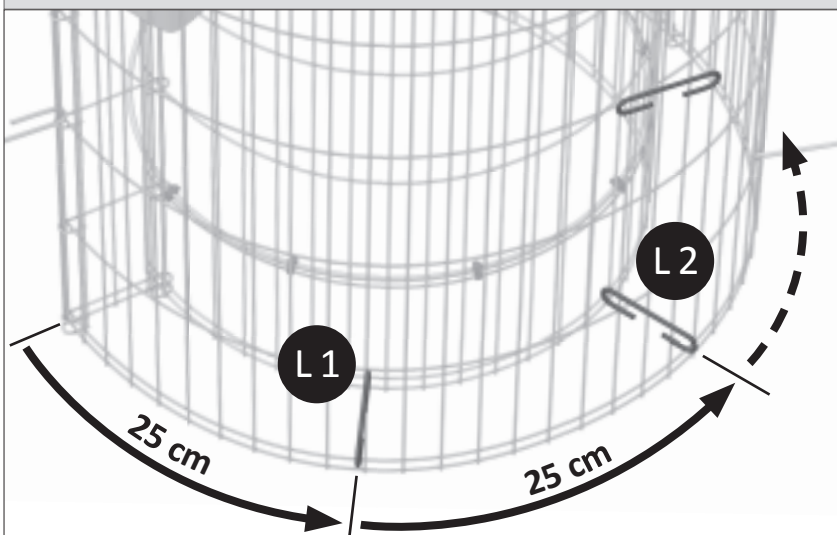
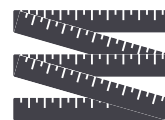

A → L 1 - L 17
 Unterste Reihe beenden.
 Terminer la dernière rangée.
 Continue lowest line.

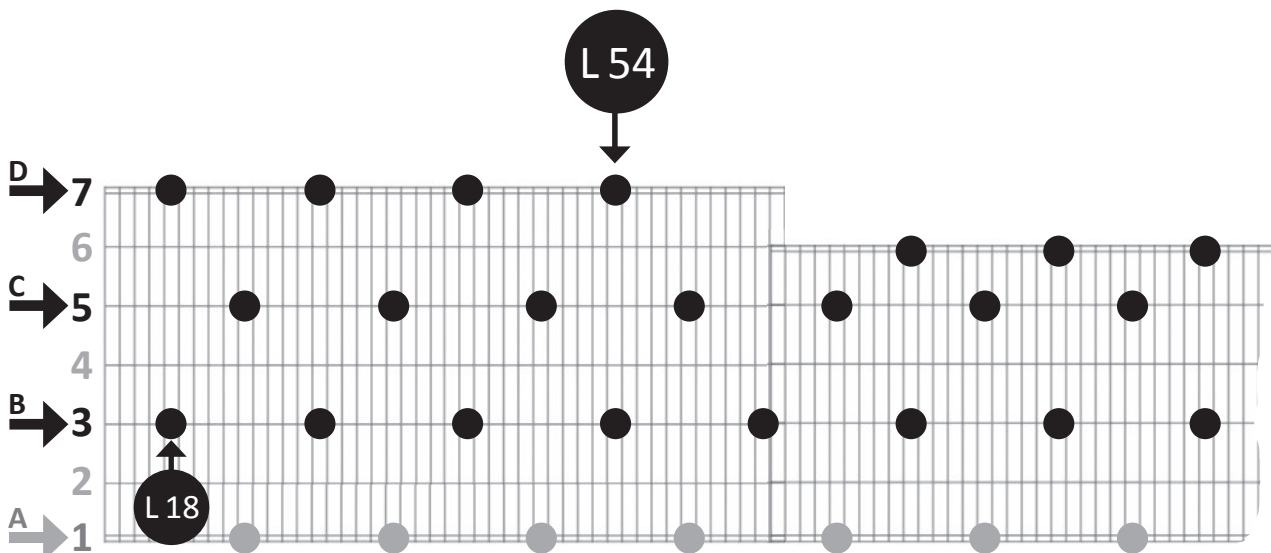
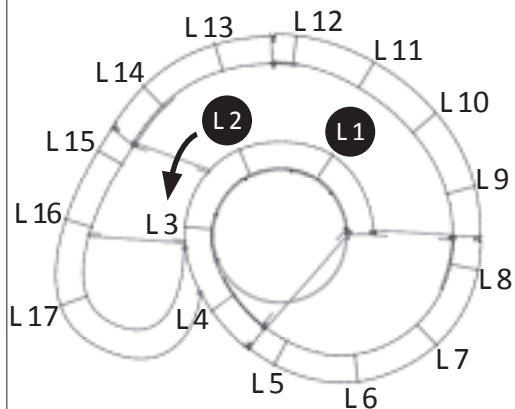

12

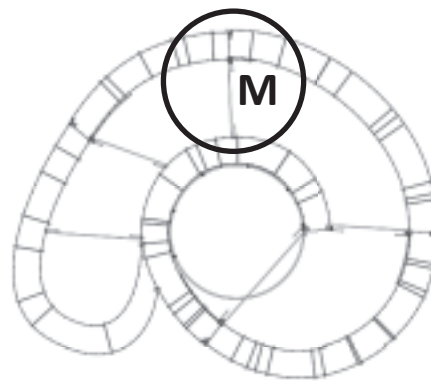
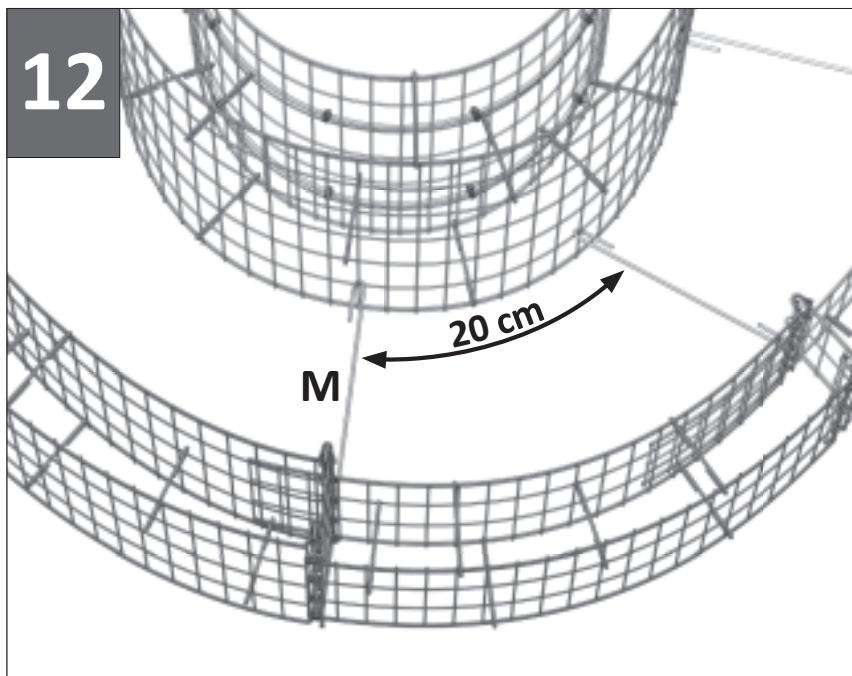

1 x **M** (20,6 cm)

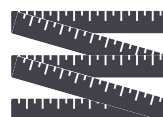

13

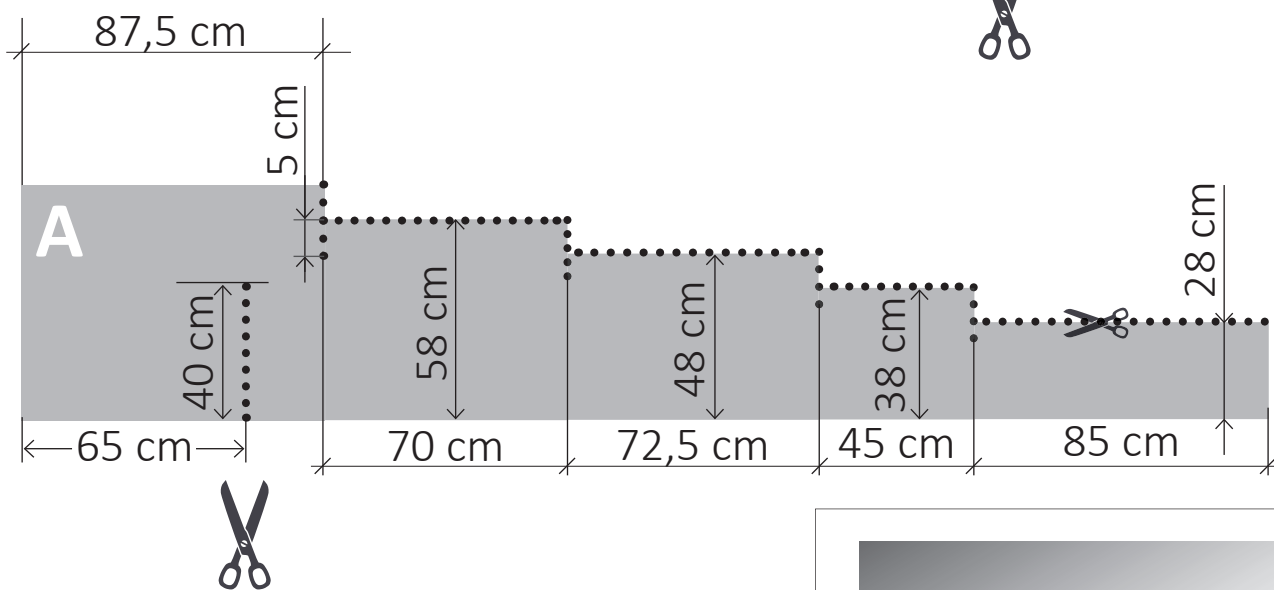

1 x **Y** (68 x 460 cm)



14

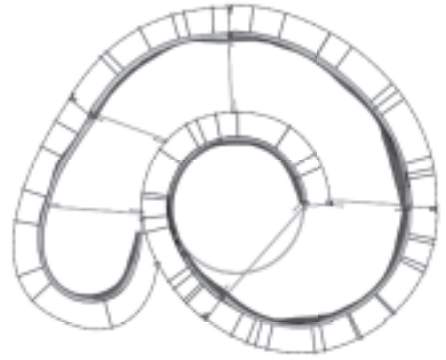
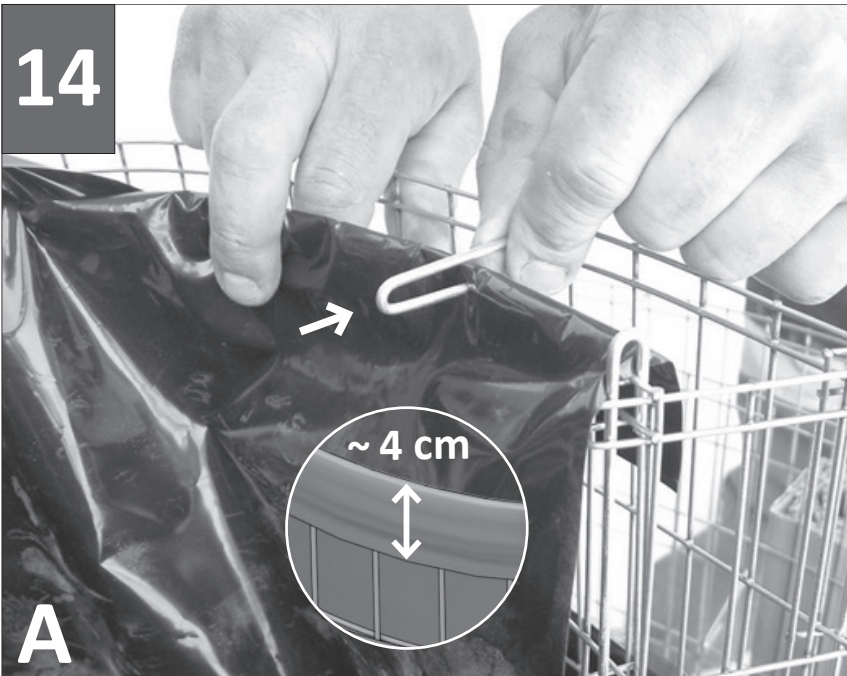

Y (68 x 360 cm)

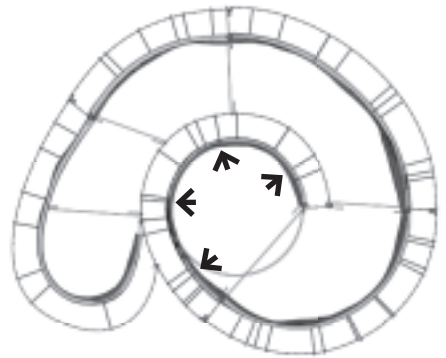
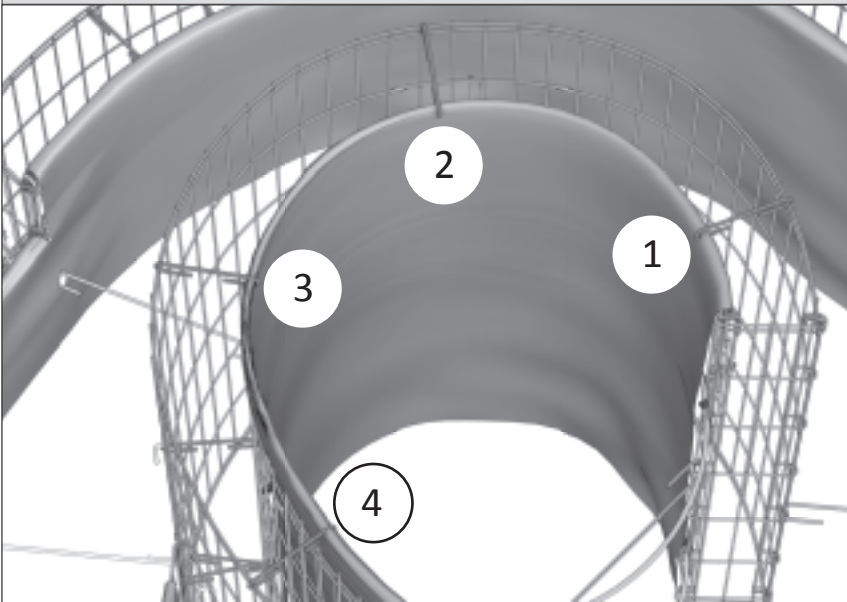

15

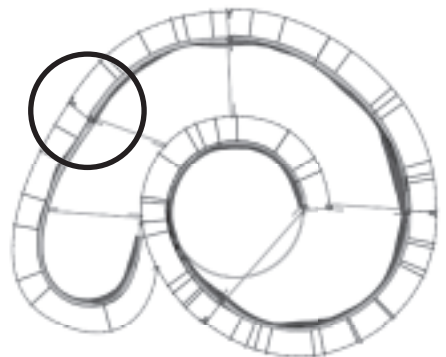
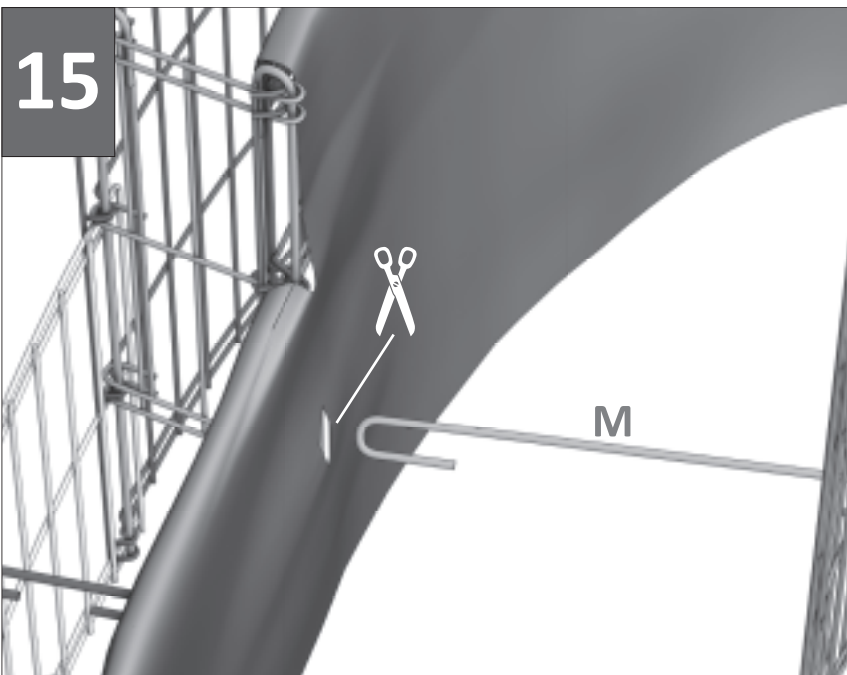

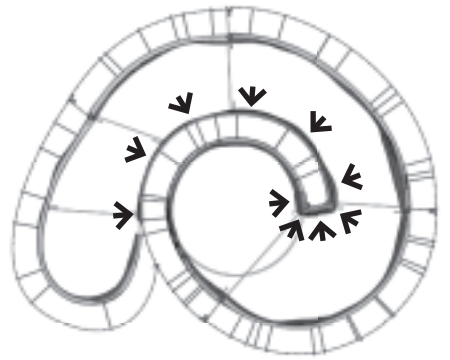
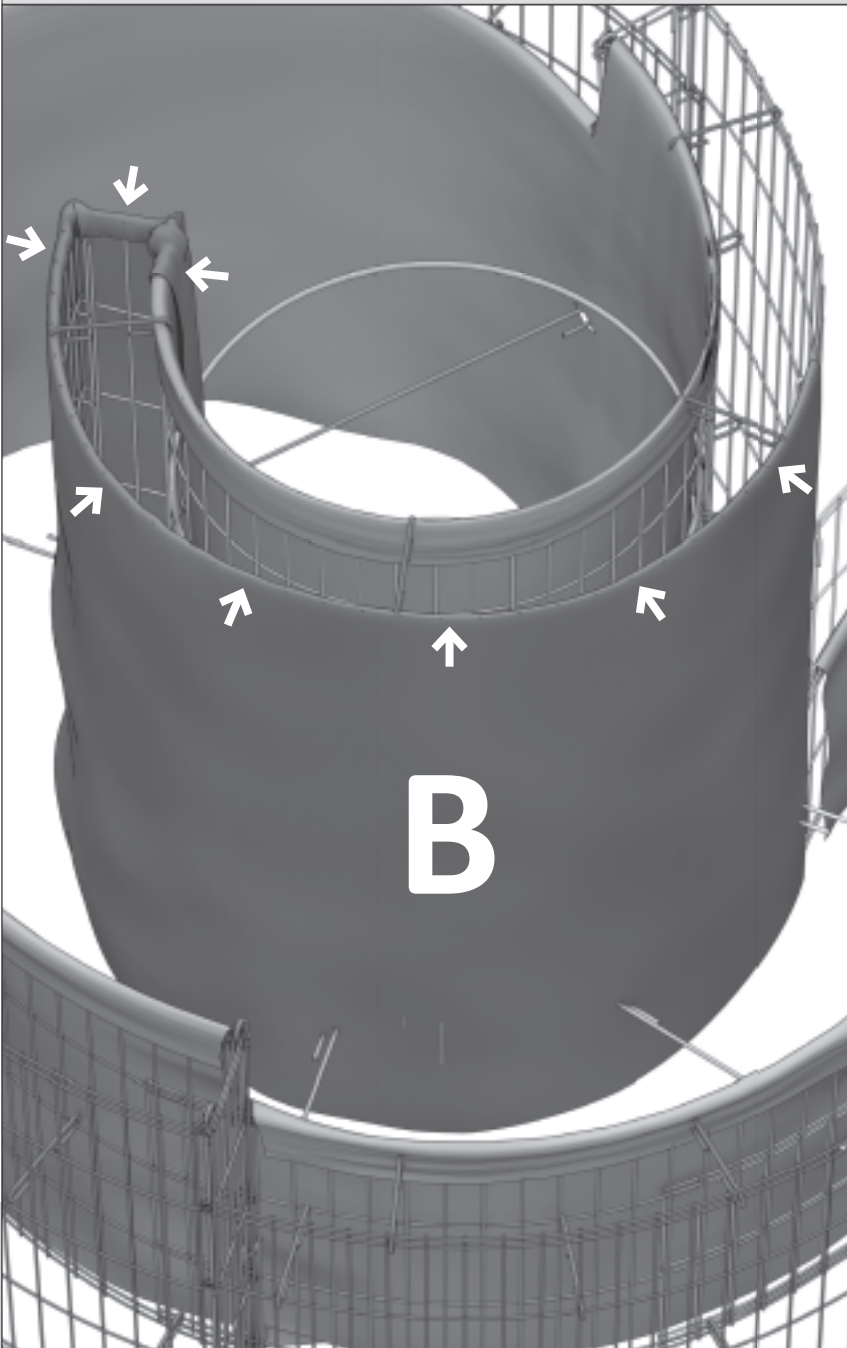
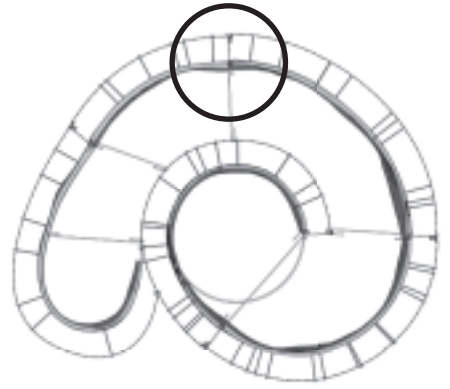
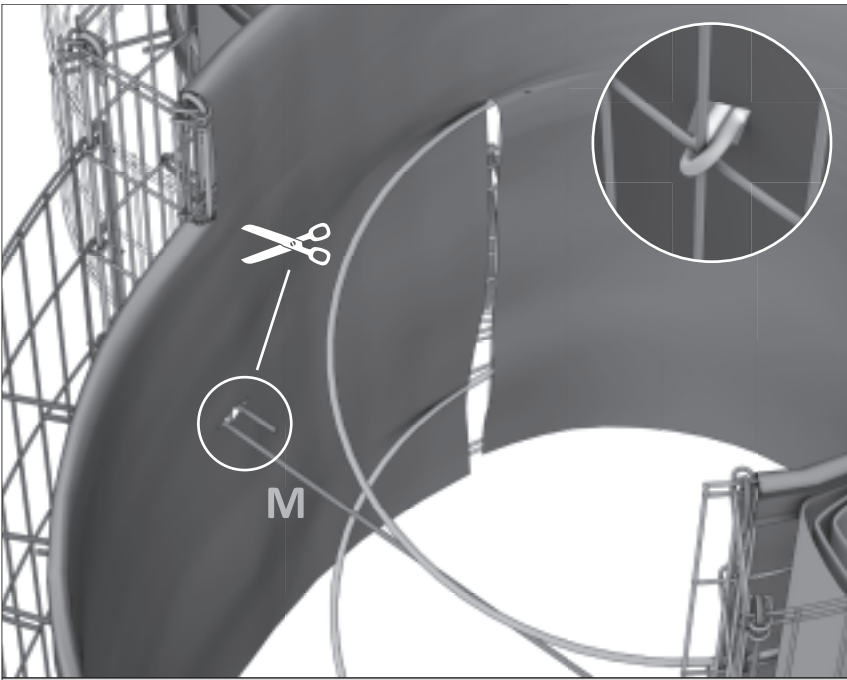

B

Y (68 x 100 cm)

16

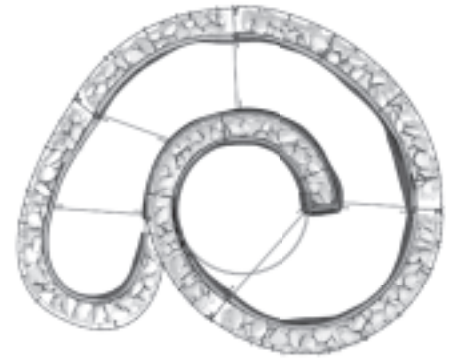
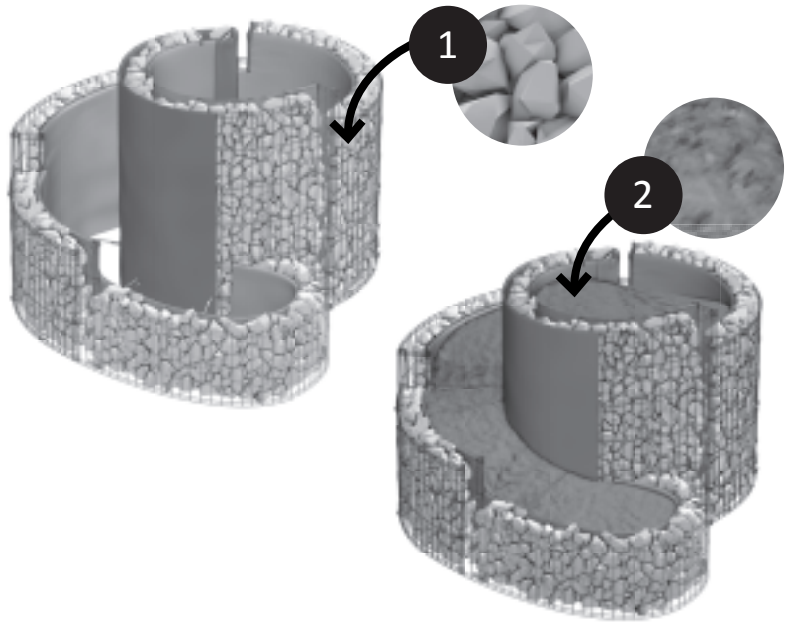
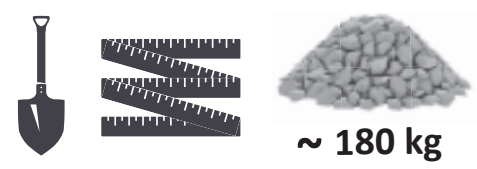
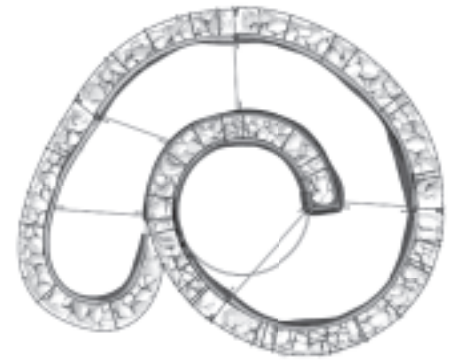
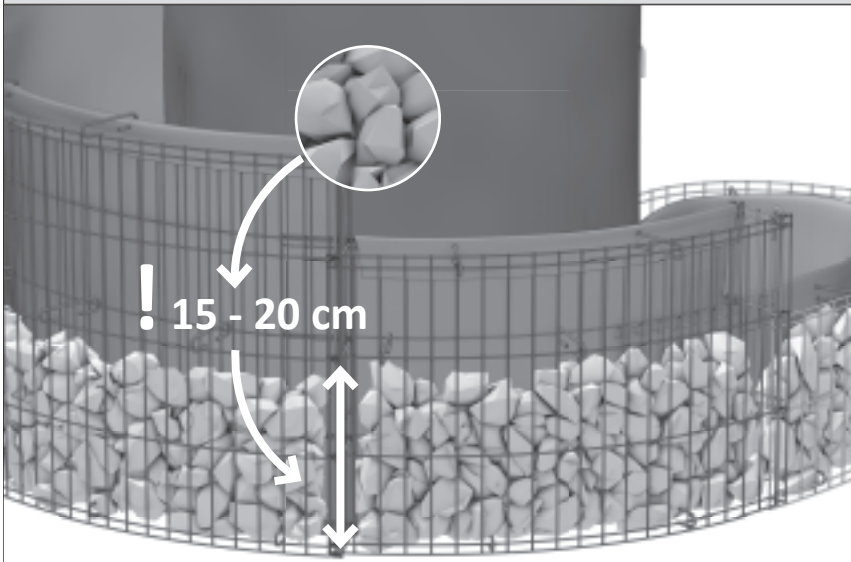
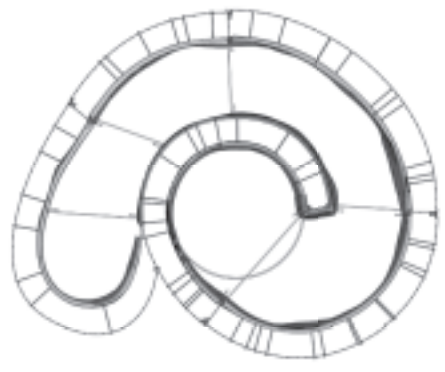
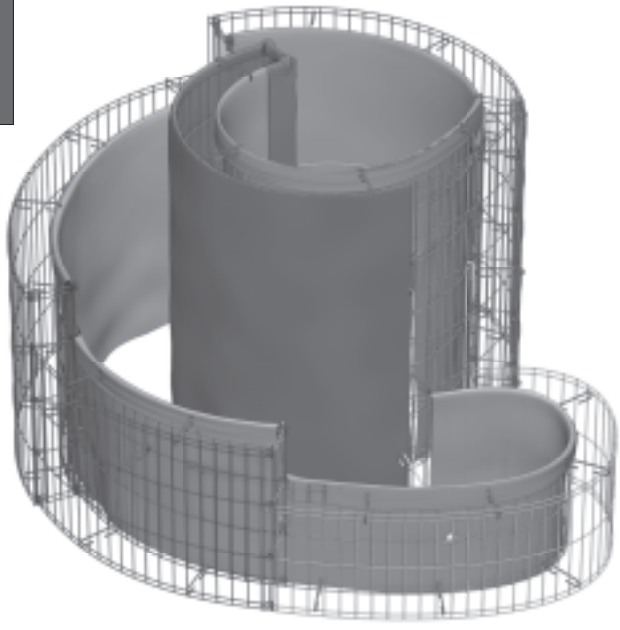

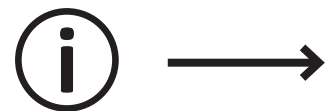
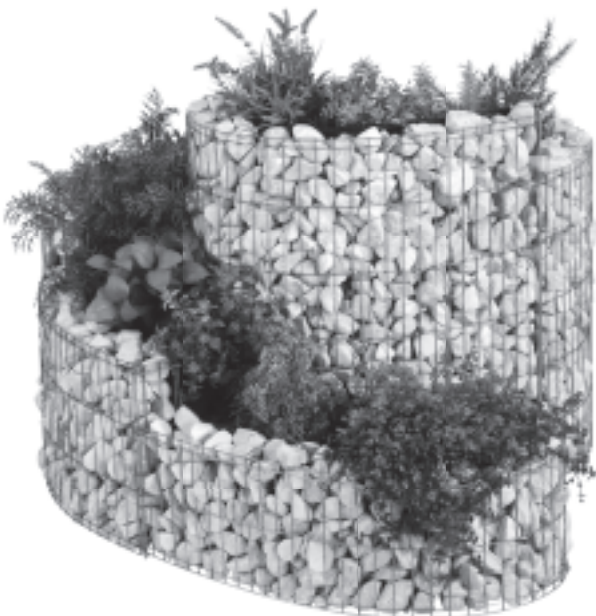
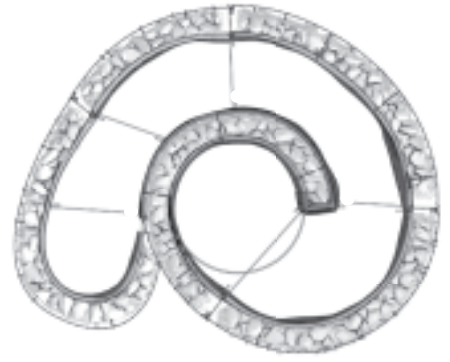
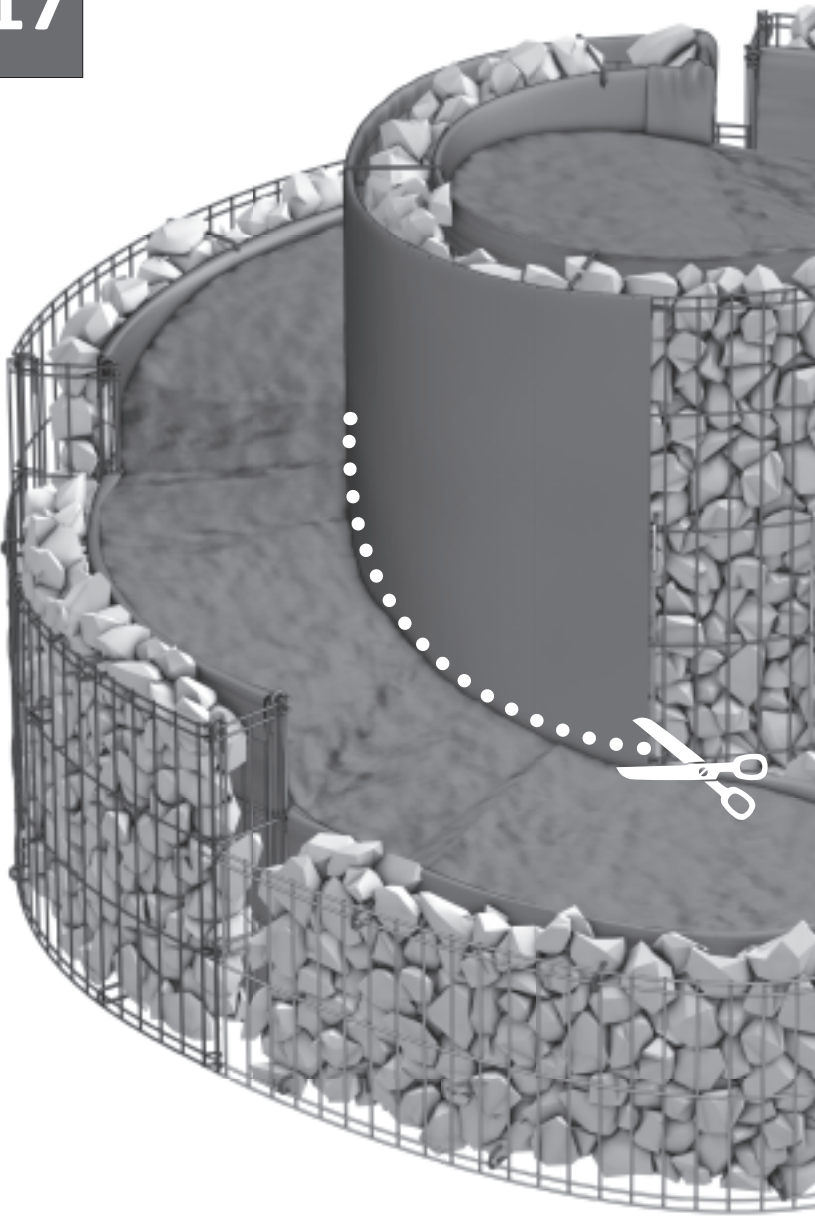

Bepflanzung

1. Klimabereiche

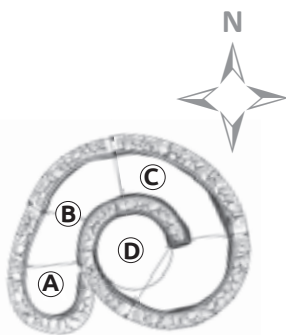

A - Wasserbereich: entsteht durch anlegen eines Minitauchs, der in Richtung Bereich "B" eine Verbindung zu seiner Umgebung haben soll.

B - Feuchtbereich: liegt direkt im Anschluss an Bereich "A" durch die Kapillarwirkung der Erde ist es dort feucht.

C - Normalbereich: durch die Nordlage halbschattig und trocken.

D - Trockenbereich: durch die hohe Südlage sehr warm und trocken.

2. Pflanzliste (Beispiele)

Bereich A	Bereich B	Bereich C	Bereich D
Bachbunze Brunnenkresse Kalmus Sauerampfer Waldmeister Wasserminze	Dill Kamille (nahe an C) Kerbel Melisse (nahe an C) Petersilie Pfefferminze Sauerampfer Schnittknoblauch Schnittlauch Wilde Rauke Zitronenmelisse	Basilikum Buschoregano Koriander Kümmel Pimpinelle Salbei (nahe an D) Weinraute	Bergbohnenkraut Currykraut Lavendel Majoran Orangenthymian Oregano Rosmarin Thymian Ysop Zitronenthymian

3. Bodenbeschaffenheit

Bereich A	Bereich B	Bereich C	Bereich D
Minitaich: aus Teichfolie oder einem Plastikbehälter ca. 40- 80 cm tief. Im Wasser sind Steine und Sand zur Wärmespeicherung.	humusreich mit kompostierter Erde angereichert. Die Erde soll das Wasser berühren.	Erd- Sandgemisch (leichter Sandanteil)	hoher Sandanteil, kalkhaltig, unter der Erde Schutt oder Steine für eine bessere Drainage

4. Allgemeines

In einer Kräuterspirale treten wesentlich weniger Schädlinge auf als in normalen Beeten. Regenwürmer sind erwünschte Bewohner der Spirale. Die vielen Steine speichern die Sonnenwärme und geben Sie langsam wieder ab, so dass sogar leichte Fröste abgefangen werden können. Hochwachsende Kräuter mit langen Wurzeln sollten nicht in die Kräuterspirale gepflanzt werden.

Plantation de la spirale à fines herbes

1. Zones climatiques

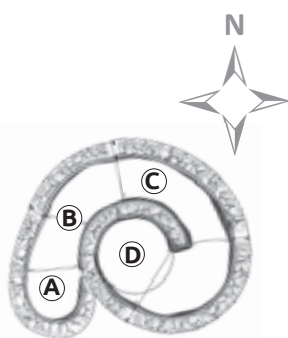

A Zone aquatique : est créée en faisant un mini étang, doté d'une jonction à son environnement en direction de la zone «**B**» ;

B Zone humide : adjacente à la zone «**A**». Il y fait humide à cause de l'effet capillaire de la terre ;

C Zone normale : semi-ombragée et sèche à cause de son exposition au nord ;

D Zone sèche : très chaude et sèche grâce à son exposition au sud ;

2. Liste des plantes (exemples)

Zone A	Zone B	Zone C	Zone D
Véronique des ruisseaux Cresson Acore odorant Oseille Reine des bois Menthe aquatique	Aneth Camomille (près de C) Cerfeuil Mélisse (près de C) Persil Menthe Oseille Ciboule de Chine Ciboulette Rucola Mélisse officinale	Basilic Origan Coriandre Cumin Pimprenelle Sauge (près de D) Rue des jardins	Sarriette de montagne Immortelle d'Italie Lavande Marjolaine Thym orange Origan Romarin Thym Hyssopus Thym citron

3. Nature du sol

Zone A	Zone B	Zone C	Zone D
Petit étang : en bâche pour bassins ou un récipient en plastique; profondeur env. 40- 80 cm. Il y a des pierres et du sable dans l'eau pour emmagasiner la chaleur ;	Riche en humus avec de la terre compostée; la terre devrait être en contact avec l'eau;	Mélange de terre et de sable; (faible part de sable)	Part de sable élevée; riche en calcaire avec des décombres ou des pierres sous la terre pour garantir un meilleur drainage ;

4. Généralités

Il y a bien moins de parasites dans une spirale à fines herbes que dans les plates-bandes classiques. Les vers de terres sont les bienvenus dans la spirale. Les nombreuses pierres emmagasinent la chaleur et la dégagent lentement, de sorte que les premières gelées ne causeront pas de dégâts. Il est recommandé de ne pas planter de fines herbes aux longues racines et qui poussent très haut dans la spirale à fines herbes.

Planting the herb spiral

1. Climate zones

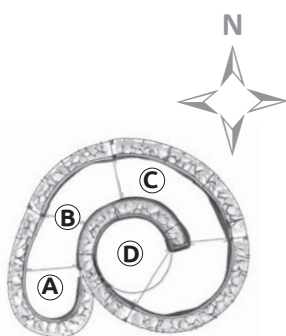

A Water zone: created by making a mini-pond, which should be linked to its surroundings in the direction of zone “B”;

B Moist zone: connects directly to zone “A”, the capillary action of the soil making it moist;

C Normal zone: the north-facing position makes it semi-shady and dry;

D Dry zone: the elevated south-facing position makes it very warm and very dry;

2. List of plants (examples)

Zone A	Zone B	Zone C	Zone D
Brooklime Watercress Sweet flag Sorrel Woodruff Water mint	Dill Chamomile (close to C) Chervil Common balm (close to C) Parsley Peppermint Sorrel Garlic chives Chives Wild rocket Lemon balm	Basil Bush oregano Coriander Caraway Salad burnet Sage (close to D) Rue	Winter savory Curry plant Lavender Majoram Orange thyme Oregano Rosemary Thyme Hyssop Lemon thyme

3. Soil properties

Zone A	Zone B	Zone C	Zone D
Mini-pond: made with pond membrane or a plastic container; approx. 40- 80 cm deep; put stones and sand in the water to store heat	Rich in humus enriched with composted soil; the soil should touch the water	Blend of soil and sand; (low sand content)	High sand content; lime content; rubble or stones under the soil for better drainage

4. General

Far fewer pests will appear in a herb spiral than in normal beds. Earthworms are desirable in the spiral. The many stones store the heat of the sun and release it slowly, so that even light frosts will not be a problem. Tall-growing herbs with long roots should not be planted in the spiral.

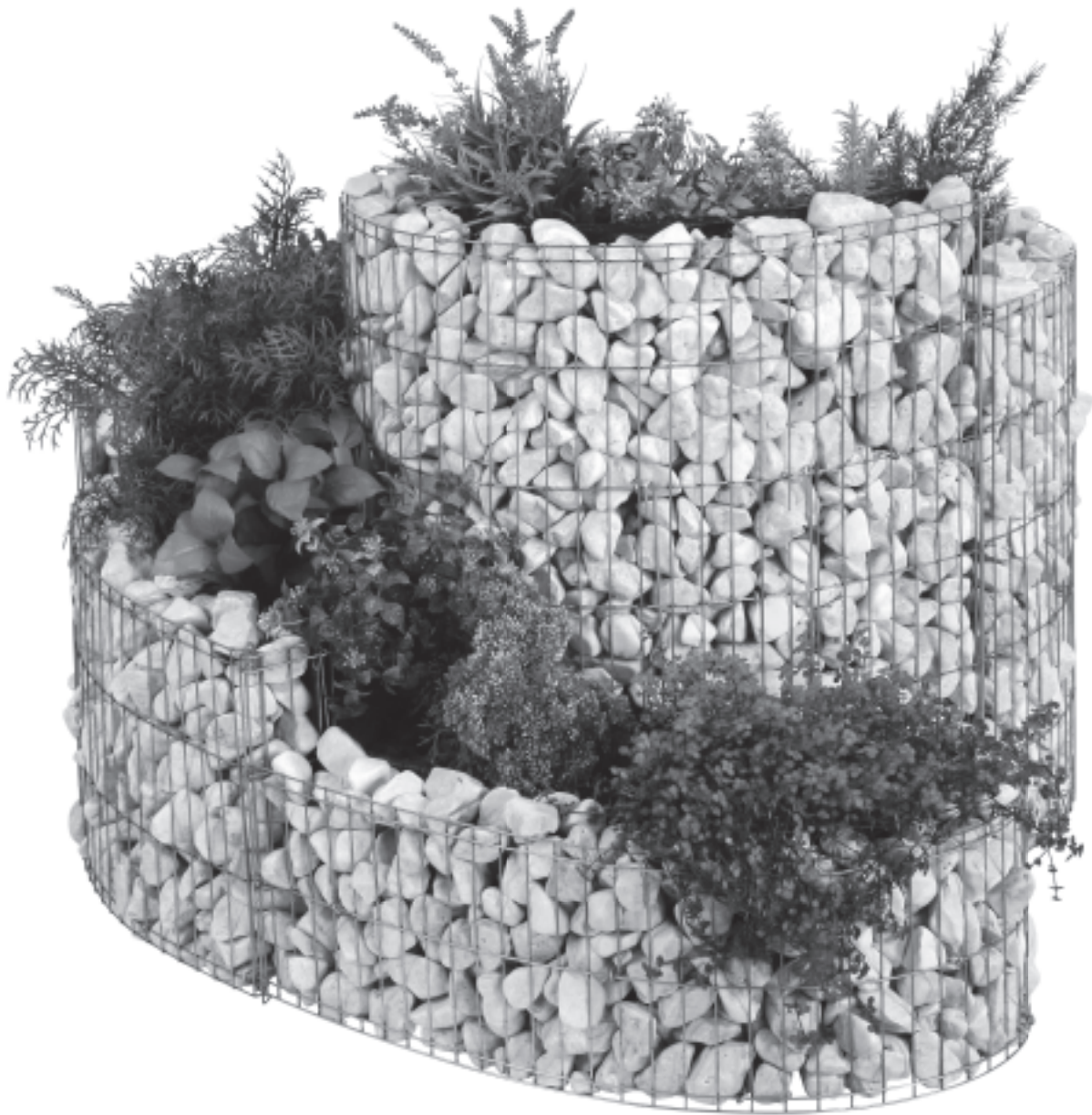

bellissa HAAS GmbH
Birkenstraße 22
D-88285 Bodnegg
www.bellissa.de